

Errata

Title & Document Type: 3577A and 35677A/B Network Analyzer Operating Manual

Manual Part Number: 03577-90003

Revision Date: May 1994

HP References in this Manual

This manual may contain references to HP or Hewlett-Packard. Please note that Hewlett-Packard's former test and measurement, semiconductor products and chemical analysis businesses are now part of Agilent Technologies. We have made no changes to this manual copy. The HP XXXX referred to in this document is now the Agilent XXXX. For example, model number HP8648A is now model number Agilent 8648A.

About this Manual

We've added this manual to the Agilent website in an effort to help you support your product. This manual provides the best information we could find. It may be incomplete or contain dated information, and the scan quality may not be ideal. If we find a better copy in the future, we will add it to the Agilent website.

Support for Your Product

Agilent no longer sells or supports this product. You will find any other available product information on the Agilent Test & Measurement website:

www.tm.agilent.com

Search for the model number of this product, and the resulting product page will guide you to any available information. Our service centers may be able to perform calibration if no repair parts are needed, but no other support from Agilent is available.

Operating Manual
Network Analyzer
HP 3577A

And

S-Parameter Test Set
HP 35677 A/B



**HEWLETT
PACKARD**

HP Part Number: 03577-90003
Microfiche Part Number : 03577-90203

Printed in U.S.A.
Print Date: May 1994

Chapter 1

Getting Started



SAFETY SUMMARY

The following general safety precautions must be observed during all phases of operation, service, and repair of this instrument. Failure to comply with these precautions or with specific warnings elsewhere in this manual violates safety standards of design, manufacture, and intended use of the instrument. Hewlett-Packard Company assumes no liability for the customer's failure to comply with these requirements. This is a Safety Class 1 instrument.

GROUND THE INSTRUMENT

To minimize shock hazard, the instrument chassis and cabinet must be connected to an electrical ground. The instrument is equipped with a three-conductor ac power cable. The power cable must either be plugged into an approved three-contact electrical outlet or used with a three-contact to two-contact adapter with the grounding wire (green) firmly connected to an electrical ground (safety ground) at the power outlet. The power jack and mating plug of the power cable meet International Electrotechnical Commission (IEC) safety standards.

DO NOT OPERATE IN AN EXPLOSIVE ATMOSPHERE

Do not operate the instrument in the presence of flammable gases or fumes. Operation of any electrical instrument in such an environment constitutes a definite safety hazard.

KEEP AWAY FROM LIVE CIRCUITS

Operating personnel must not remove instrument covers. Component replacement and internal adjustments must be made by qualified maintenance personnel. Do not replace components with power cable connected. Under certain conditions, dangerous voltages may exist even with the power cable removed. To avoid injuries, always disconnect power and discharge circuits before touching them.

DO NOT SERVICE OR ADJUST ALONE

Do not attempt internal service or adjustment unless another person, capable of rendering first aid and resuscitation, is present.

DO NOT SUBSTITUTE PARTS OR MODIFY INSTRUMENT

Because of the danger of introducing additional hazards, do not install substitute parts or perform any unauthorized modification to the instrument. Return the instrument to a Hewlett-Packard Sales and Service Office for service and repair to ensure the safety features are maintained.

DANGEROUS PROCEDURE WARNINGS

Warnings, such as the example below, precede potentially dangerous procedures throughout this manual. Instructions contained in the warnings must be followed.

Warning



Dangerous voltages, capable of causing death, are present in this instrument. Use extreme caution when handling, testing, and adjusting.



CERTIFICATION

Hewlett-Packard Company certifies that this product met its published specifications at the time of shipment from the factory. Hewlett-Packard further certifies that its calibration measurements are traceable to the United States National Bureau of Standards, to the extent allowed by the Bureau's calibration facility, and the calibration facilities of other International Standards Organization Members.

WARRANTY

This Hewlett-Packard product is warranted against defects in material and workmanship for a period of one year from date of shipment. During the warranty period, Hewlett-Packard Company will, at its option, either repair or replace products which prove to be defective. For warranty service or repair, this product must be returned to a service facility designated by HP. Buyer shall prepay shipping charges to -hp- and -hp- shall pay shipping charges to return the product to Buyer. However, Buyer shall pay all shipping charges, duties, and taxes for products returned to -hp- from another country.

HP software and firmware products which are designated by HP for use with a hardware product, when properly installed on the hardware product, are warranted not to fail to execute their programming instructions due to defects in materials and workmanship. If HP receives notice of such defects during their warranty period, HP shall repair or replace software media and firmware which do not execute their programming instructions due to such defects. HP does not warrant that the operation of the software, firmware or hardware shall be uninterrupted or error free.

LIMITATION OF WARRANTY

The foregoing warranty shall not apply to defects resulting from improper or inadequate maintenance by Buyer, Buyer-supplied software or interfacing, unauthorized modification or misuse, operation outside of the environmental specifications for the product, or improper site preparation or maintenance.

NO OTHER WARRANTY IS EXPRESSED OR IMPLIED. HEWLETT-PACKARD SPECIFICALLY DISCLAIMS THE IMPLIED WARRANTIES OF MERCHANTABILITY AND FITNESS FOR PARTICULAR PURPOSE.

EXCLUSIVE REMEDIES

THE REMEDIES PROVIDED HEREIN ARE BUYER'S SOLE AND EXCLUSIVE REMEDIES. HEWLETT-PACKARD SHALL NOT BE LIABLE FOR ANY DIRECT, INDIRECT, SPECIAL, INCIDENTAL, OR CONSEQUENTIAL DAMAGES, WHETHER BASED ON CONTRACT, TORT, OR ANY OTHER LEGAL THEORY.









ASSISTANCE

Product maintenance agreements and other customer assistance agreements are available for Hewlett-Packard products.

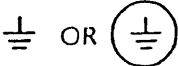
For any assistance, contact your nearest Hewlett-Packard Sales and Service Office. Addresses are provided at the back of this manual.

SAFETY SYMBOLS

General Definitions of Safety Symbols Used On Equipment or In Manuals.

	Instruction manual symbol: the product will be marked with this symbol when it is necessary for the user to refer to the instruction manual in order to protect against damage to the instrument.
	Indicates dangerous voltage (terminals fed from the interior by voltage exceeding 1000 volts must be so marked.)
	Protective conductor terminal. For protection against electrical shock in case of a fault. Used with field wiring terminals to indicate the terminal which must be connected to ground before operating equipment.
	Low-noise or noiseless, clean ground (earth) terminal. Used for a signal common, as well as providing protection against electrical shock in case of a fault. A terminal marked with this symbol must be connected to ground in the manner described in the installation (operating) manual, and before operating the equipment.
	Frame or chassis terminal. A connection to the frame (chassis) of the equipment which normally includes all exposed metal structures.
	Alternating current (power line.)
	Direct current (power line.)
	Alternating or direct current (power line.)

Warning



The **WARNING** sign denotes a hazard. It calls attention to a procedure, practice, condition or the like, which if not correctly performed or adhered to, could result in injury or death to personnel.

Caution



The **CAUTION** sign denotes a hazard. It calls attention to an operating procedure, practice, condition or the like, which, if not correctly performed or adhered to, could result in damage to or destruction of part or all of the product.

Note



The **NOTE** sign denotes important information. It calls attention to procedure, practice, condition or the like, which is essential to highlight.

Table of Contents

Introduction of the HP 3577A Network Analyzer and the S-Parameter Test Set

Front Panel Overview	I-2
Rear Panel Overview	I-4
How To Use This Manual	I-5
Instrument Description	I-6
Initial Inspection	I-7

Chapter 1: Getting Started

Introduction	1-1
Instrument Turn On	1-2
“Hardkeys” & “Softkeys”	1-4
Definitions & Operating Hints	1-4
In Case of Trouble	1-6
Confidence Test	1-7

Chapter 2: Making Measurements

Tuned Stub Notch Filter	2-3
Measurement Set Up	2-5
Making Measurements	2-9
Store Trace Data	2-14
Save Instrument State	2-16
Bandpass Filter	2-17
Measurement Set Up	2-19
Bandwidth Measurements	2-25
Passband Ripple	2-30
Passband Insertion Phase	2-33
Group Delay	2-35
Amplifier	2-37
Gain Compression	2-37
Low Pass Filter	2-42
Measurement Set-up	2-44
Insertion Loss	2-46
Insertion Phase	2-47

Passband Ripple	2-48
Stopband Rejection	2-50
Amplifier S-Parameters	2-52
Measurement Setup	2-53
S ₂₁ ' Forward Gain and Phase	2-56
S ₁₂ Reverse Loss	2-58
S ₁₁ ' Input Return Loss	2-61
S ₂₂ ' Output Reflection Coefficient	2-64
Complex Output Impedance	2-66

Chapter 3: Remote Operation

The Hewlett-Packard Interface Bus	3-1
What is the HP-IB?	3-1
How does the HP-IB Operate?	3-1
HP-IB Specification Summary	3-2
Bus Structure	3-3
Management (CONTROL) Lines.	3-3
The and the HP-IB	3-4
HP-IB Capability	3-4
Data Format Vs Transfer Rate	3-5
Direct Plotting	3-6
HP-IB Verification	3-6
HP-IB Diagnostic Mode	3-7
The 's HP-IB Address	3-8
Talk/listen Addresses	3-8
Viewing the 's HP-IB Address	3-8
Setting the HP 3577A 's HP-IB Address	3-9
Bus Messages	3-11
Bus Commands	3-11
Device Dependent Commands	3-15
Display Format	3-18
Source	3-23
Receiver	3-27
Instrument State	3-28
HP-IB Only Commands	3-30
Instrument Preset (default) Parameter Values	3-59
The Status Byte	3-62
Status Byte Bit Numbers	3-62
"How To Go Fast" Example Programs	3-64

Chapter 4: Reference

Amplitude	4-1
Attenuation	4-4
Average	4-6
Continuous Entry	4-8
Data Entry	4-9
Data Register	4-11
Define Math	4-12
Display Format	4-14
Display Function	4-15
Entry Block	4-20
External Reference	4-21
Frequency	4-22
Graticule	4-25
Hardkey	4-26
Input	4-27
Instrument Preset	4-30
Instrument State	4-32
Knob	4-33
Length	4-34
Local	4-35
Marker	4-36
Marker →	4-39
Measurement Calibration	4-44
Menu	4-50
Message Block	4-52
Output	4-53
Overload	4-54
Plot	4-55
Recall Instrument State	4-59
Receiver	4-60
Resolution Bandwidth	4-61
S-Parameter Test Set	4-63
Save Instrument State	4-65
Scale	4-66
Screen	4-69
Softkey	4-70
Source	4-71

Special Functions	4-72
Store Data	4-75
Sweep Mode	4-77
Sweep Time	4-79
Sweep Type	4-81
Trace 1	
Trace 2	4-85
Trigger Mode	4-86
Trigger/Reset	4-88

Chapter 5: General Information

Introduction	5-1
Initial Inspection	5-1
Power Requirements	5-2
Power Cable And Grounding Requirements	5-2
Operating Environment	5-4
Accessories Available	5-6
Accessories Supplied	5-6
Options	5-7
Installation	5-8
HP-IB Connections	5-11
Storage and Shipment	5-13
Source Characteristics	5-14
Frequency Characteristics	5-14
Output Characteristics	5-14
Sweep Characteristics	5-14
Receiver Characteristics	5-15
Input Characteristics	5-15
Magnitude Characteristics	5-16
Phase Characteristics (A/R,B/R,A/B):	5-17
Polar Characteristics	5-18
Real/imaginary Characteristics	5-18
Delay Characteristics	5-18
Display Characteristics	5-20
Programming Characteristics	5-21
General Characteristics	5-22

Appendix A: Special Topics

Data Processing and Structure A-1
Optimizing Sweep Time A-4

Appendix B: Remote Graphics

Digital Display Quick Reference Guide B-1
Digital Display Commands B-1

Appendix C: Screen Messages

Message and Description C-1

Appendix D: Programming Codes

HP 3577A Programming Codes D-1

Appendix E: Bibliography

!

**Introduction of the
HP 3577A Network Analyzer and the
HP 35677A/B S-Parameter Test Set**

Front Panel Overview

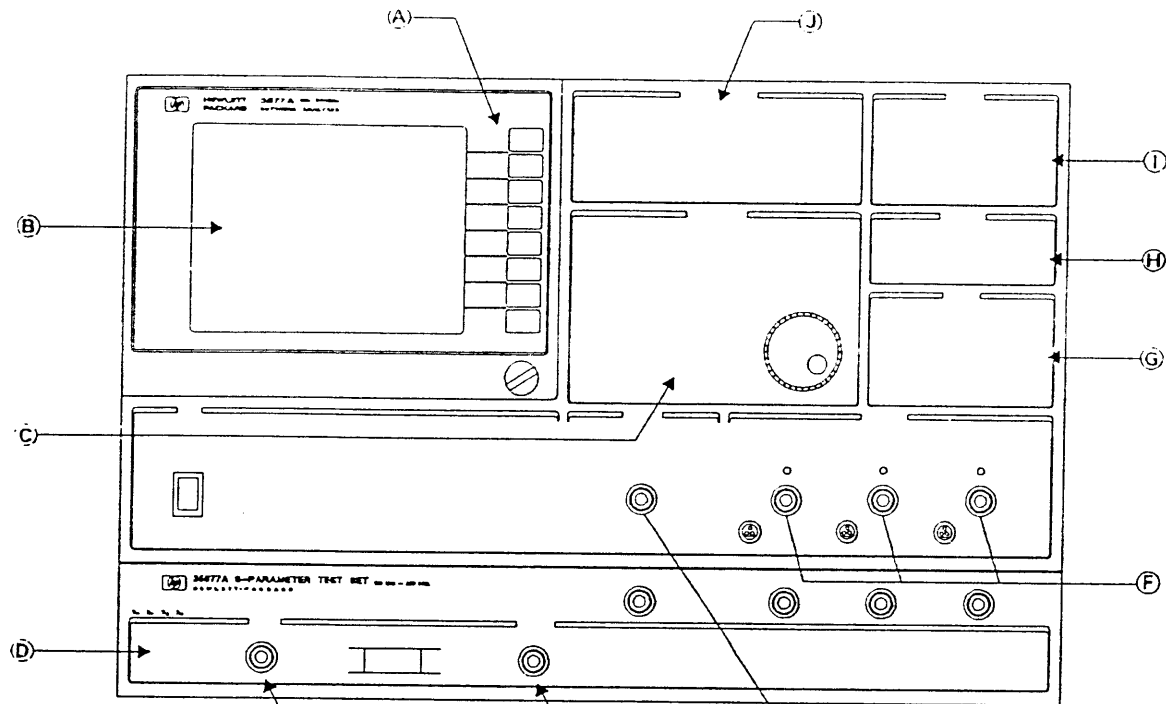

- CAUTION**
- 1 Do not exceed maximum signal level of +27dbm or 30 VDC on either test port. If either of these levels is exceeded, damage to the instrument may result.
 - 2 The HP 35677B has 75Ω type-N female connectors for test ports one and two. These connectors may be physically damaged if 50Ω type N connectors are used on the test ports.

A. Softkeys

Select items from the menus using these eight keys beside the display. Select a parameter for data entry, perform an immediate execution function, make a selection from a list, or display the next level menu.

- **Data Entry Block:** appears when a data entry softkey is active or bright, and displays the current value of the parameter. When entering or modifying new data, it displays the new value.
- **Graticule:** is displayed in linear, log, or Smith Chart formats.
- **Menu Area:** is located on the right side of the screen, indicating the softkey labels of the chosen parameter.

B. Screen Areas

The TRACE hardkeys in the DISPLAY FORMAT section select the active trace. This trace and the associated measurement parameters are shown on the screen in several information blocks or areas.

- **Marker Information Block:** appears in the upper right-hand corner of the screen above the graticule. It describes the trace display function and input definition, and lists the marker position and measured value for each trace.
- **Scale Information Area:** appears in the upper left-hand corner of the screen above the graticule. It defines both the reference level (dashed line) and the vertical scale in units/division for each trace.

C. Data Entry

The data entry section contains the numeric key pad and the knob. Turning the knob moves the marker or modifies a data entry. The key above the knob toggles between the marker and data entry modes. Correct an entry error by using the backspace key. The entry off key clears the menu, which effectively eliminates further data entry.

D. S-Parameter Test Set

The HP 35677A/B is a 100 kHz to 200 MHz scattering parameter test set built for use with the HP 3577A Network Analyzer. The A model has 50 Ω test ports and the B model has 75 Ω test ports. This test set provides a convenient method for making reflection and transmission measurements of one and two-port devices. The HP 3577A provides signal, power, and control for the test set and provides a menu which includes S-parameter socket selections S11, S21, S12, and S22.

E. Source Output

The source output has overvoltage protection circuitry that disconnects the output from the source when a signal is 4 V_{pk} or greater.

F. Receiver Inputs

All three inputs have overvoltage protection circuitry that senses signal levels greater than 1.1 V_{pk} and switches the input impedance to 1 M Ω . The inputs may be overloaded without switching if the signal level beyond the input attenuation exceeds -20 dBm, but does not exceed 1.1 V_{pk}. This condition causes inaccurate information to be displayed and is indicated by an audible alarm, illumination of red alarm LEDs over each overloaded input and a warning message displayed on the screen.

G. Instrument State

- Special Functions: HP-IB address, talk only on/off, confidence tests, beeper on/off, service diagnostics, INPUT menu S-parameters on/off.
- Save Instrument State: saves the current state in one of five registers.
- Recall Instrument State: recalls a saved instrument state or the state of the instrument at the last power down.
- Plot: controls all plotting parameters to an HP-IB plotter.

H. Receiver

- Resolution Bandwidth: provides 1 kHz, 100 Hz, 10 Hz, and 1 Hz.
- Averaging: selects a weighting value for exponential vector averaging.
- Input Attenuation and Impedance: allows selection of attenuation (0 dB, 20 dB), and impedance (50 Ω or 1 M Ω), and clears receiver trip(s).
- Length: allows for data corrections for cable lengths in units of meters or seconds.

I. Source

- Sweep Type: selects linear frequency sweep, alternate sweep, log frequency sweep, amplitude sweep, CW, or sweep direction up or down.
- Sweep Mode: selects continuous, single, or manual modes.
- Sweep Time: is selectable from 100 ms/span to 6553 s/span for linear sweep type.
- Frequency: specifies the start, stop, and center frequencies, frequency span, center frequency step size, sweep resolution, and full sweep.
- Amplitude: ranges from -49 dBm to +15 dBm in 0.1 dBm increments. It can also clear a source trip.
- Trigger Mode: available in free run, line, external, and immediate.

J. Display Format

- Input: R, A, B, A/R, B/R, user defined inputs, S11, S21, S12, S22.
- Display Function: log magnitude, linear magnitude, phase, polar, real, imaginary, group delay.
- Scale: autoscale, reference level, /DIV, reference position, reference line on/off, copy scale, phase slope value, phase slope on/off.
- Marker: marker position, marker on/off, zero marker, marker offset on/off, marker offset (value), frequency offset (value), marker coupling on/off.
- Store Data: store data to one of four registers, user defined store, store and compare.
- Measurement Calibration: Normalize, normalize with a short, one port partial calibration, one port full calibration.
- Define Math: User may define three complex constants (K1-K3), and five functions (F1-F5).
- Marker → ...reference level, ...start frequency, ...stop frequency, ...center frequency, ...maximum, ...minimum, marker offset → frequency span, marker search right or left for target value.

Rear Panel Overview

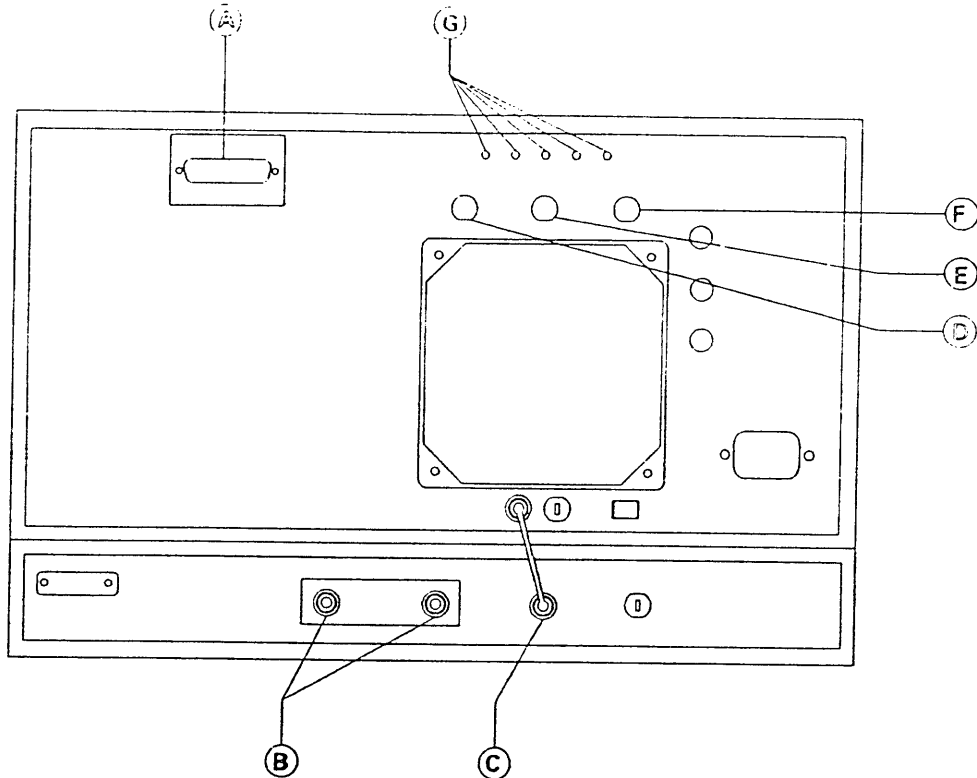

A. HP-IB Port:

Control operation of the HP 3577A from a remote controller. This connector uses metric fasteners and is not compatible with older cables using English fasteners. Metric fasteners are available from HP to upgrade older cables.

B. Port Bias 1 & 2:

Two inputs on the rear of the HP 35677A/B serve to connect a bias voltage to the front panel connections labeled PORT 1 or PORT 2.

C. Instrument Interconnect:

The HP 3577A is connected to the HP 35677A/B S-Parameter Test Set at the rear panel with the interconnect cable. This cable supplies power to the test set, controls the configuration of the test set, and allows the HP 3577A to sense the presence of the test set, changing the INPUT menu.

D. External Trigger:

This input is used to trigger a measurement on the falling edge of a TTL signal or a switch closure to ground.

E. 10 MHz Output:

A frequency reference output provides a 0 dBm signal with stability of 0.05 ppm per °C.

F. External Reference In:

This input is used to phase lock the HP 3577A to an external frequency reference. The signal applied should be between -7 and +15 dBm. The frequency of the external reference may be any subharmonic of 10 MHz, but greater than 100 kHz.

G. CRT Display Adjustments:

See Installation in the General Information section.

How To Use This Manual

The GETTING STARTED section is designed to help the first-time user. This section describes how to turn on the HP 3577A. It also defines some terms used in this manual, gives operating hints, and shows how to run the confidence test.

The MEASUREMENT section describes the use of the HP 3577A Network Analyzer and the HP 35677A/B S-Parameter Test Set in making typical measurements on several common devices. These measurements are examples that cover topics of general interest and demonstrate the capabilities of the HP 3577A and the HP 35677A/B.

The REMOTE OPERATION section describes the Hewlett-Packard Interface Bus and how it is used to operate the HP 3577A with a controller (computer). To use the HP 3577A under remote control, first become acquainted with front panel operation then refer to the REMOTE OPERATION section.

The REFERENCE section is an alphabetical listing of the front panel sections, hardkeys, and terms. Each hardkey topic shows its associated softkeys and describes each softkey command in detail.

Before proceeding, read Installation in the General Information section. This reading covers initial inspection, power requirements, power cable and grounding requirements, installation for the HP 3577A and the HP 35677A/B, and definition of the operating environment.

Instrument Description

The HP 3577A Network Analyzer is a three-input, dual trace, synthesized, 5 Hz–200 MHz programmable network analyzer. It features menu-driven operation, using eight softkeys located next to the menu display area of the CRT. A menu is a list of softkey labels that appears on the CRT next to the softkeys. Display a menu by pressing the hardkey for the parameter to be modified or the measurement to be made. This permits control of many features with a minimum number of front panel keys by redefining the softkeys with each new menu. Marker information and sweep parameters are displayed above and below the CRT graticule and give the current instrument status.

Trace information displayed on the HP 3577A CRT is digitally stored as complex data (real and imaginary) in trace memory. Using the storage and math processing capabilities of the HP 3577A, up to eight different display formats may be derived from the same trace data and changes in scale may be made without repeating the measurement.

All HP 3577A graticules are electronically generated on the screen as part of the display operation. Thus, no screen overlays are needed for polar or log graticules or the Smith chart. In log sweep the graticule changes to reflect changes in start and stop frequencies.

Other features of the HP 3577A include

- Electrical length correction/measurement
- Automatic plot routines for HP-GL plotters
- User defined vector math
- Vector averaging
- 1 Hz resolution bandwidth
- Automatic self-protection on the source output and receiver inputs
- The ability to save and recall five instrument states

The HP 3577A has three functional blocks: SOURCE, RECEIVER, and DISPLAY FORMAT. The source and receivers work together to gather data and store it in trace memory. The display section takes the trace data and formats it for viewing.

Initial Inspection

This instrument was carefully inspected both mechanically and electrically before shipment. It should meet published specifications. To confirm this, inspect the instrument for physical damage incurred in transit, inventory the supplied accessories (listed in table 5-2), and test the electrical performance using the Confidence Test listed in the section on Getting Started. If there is physical damage, if the contents are incomplete or if the instrument does not pass the Confidence Test, notify the nearest HP Sales and Service Office. If the shipping container is damaged or the cushioning material shows signs of stress, notify the carrier as well as the Hewlett-Packard office. Keep the shipping material for the carrier's inspection.

Warning



The integrity of the protective earth ground may be interrupted if the HP 3577A is mechanically damaged. Under no circumstance should the HP 3577A be connected to power if it is damaged.

Getting Started

Introduction

This section is designed to get the first time user ready to make measurements. To do this the HP 3577A must be configured and fused for the available line voltage and safely connected to the power line before it is turned on. As the CRT warms up, a self test is run that sounds the beeper, illuminates all the front panel LED's and tests internal RAM and ROM. By the time the CRT is warm enough to display a screen, normal operation has begun. Approximately ten minutes after power is turned on, the beeper will sound again as the oven reference reaches operating temperature and switches in as the frequency reference for the HP 3577A Network Analyzer.

After the detailed turn-on procedure is a definition of some of the terms commonly used in this manual and some operating hints to help the new user establish good operating habits. "IN CASE OF TROUBLE" is included under operating hints.

Instrument Turn On

1. Before connecting ac power to the HP 3577A
 - a. Set the rear panel VOLTAGE SELECTOR switch to the position that corresponds to the powerline voltage to be used:

Voltage Selector	Line Voltage
115V	86V to 127V at 48 Hz to 440 Hz
230V	195V to 253V at 48 Hz to 66 Hz

Warning



To avoid serious injury, be sure that the ac power cord is disconnected before removing or installing the ac line fuse.

- b. Verify that the proper line fuse is installed in the rear-panel FUSE holder:

Voltage Selector	Fuse Type	HP Part No.
115V	6A, 250V Normal Blo	2110-0056
230V	3A, 250V Normal Blo	2110-0003

Warning



To protect operating personnel, the HP3577A chassis and cabinet must be grounded. The HP 3577A is equipped with a three-wire power cord which, when plugged into an appropriate receptacle, grounds the instrument. To preserve this protection feature the power plug must be inserted in a three-terminal receptacle having a protective earth ground contact. The protective action must not be negated by the use of an extension cord or adapter that does not have the required earth ground connection. Grounding one conductor of a two-conductor outlet is not sufficient protection.

Ensure that all devices connected to the HP 3577A are also connected to the protective earth ground.

- c. Set the front panel power switch to the OFF position.
- d. Connect the ac power cord to the rear panel LINE connector. Plug the other end of the power cord into a three-terminal grounded power outlet.
- e. Turn on the power to the instrument by pressing the LINE switch on the front panel to the ON position. Verify that all front panel LED's illuminate simultaneously soon after the HP 3577A is turned on.

Note



Each time the HP 3577A is powered ON a self-test of ROM and RAM is run and the results (pass/fail) are displayed on the screen. (Normally the CRT will not display these results because it hasn't warmed up). The beeper will sound and all front panel LED's should illuminate when the instrument is first turned on. The operator should visually verify that all LED's illuminate.

-
- f. Verify that the cooling fan on the rear panel is operating and that the SWEEP LED on the front panel is flashing about once per second.
 - g. Approximately ten minutes after power-on the beeper will sound and the screen message "REFERENCE UNLOCKED" will appear very briefly. This indicates that the oven reference has reached operating temperature and has been selected as the frequency reference for the Voltage Controlled Crystal Oscillator (VCXO). When the switch occurs, the VCXO takes a moment to achieve phase lock which causes the screen message. Until this switch occurs the VCXO uses its own 10 MHz crystal as the frequency reference. If "REFERENCE UNLOCKED" remains on the screen, contact an authorized repair facility.

Note



The internal oven will automatically become the frequency reference when it reaches operating temperature; no external connections are necessary. The jack on the rear panel marked EXTERNAL REFERENCE should not be connected to the 10 MHz REFERENCE OUTPUT beside it.

"Hardkeys" & "Softkeys"

Before using the analyzer, it is important to understand the difference between hardkeys and softkeys.

Hardkeys are front panel buttons whose functions are always the same. Most hardkeys have a label printed directly on the key. Throughout this book, they are printed like this: **HARDKEY**

Softkeys are keys whose functions change with the analyzer's current menu selection. A softkey's function is indicated by video label to the left of the key (along the edge of the CRT display). Throughout this book, they are printed like this: **SOFTKEY**

Definitions & Operating Hints

1. It is good practice to start a measurement setup by pressing **INSTR PRESET**. This is a quick way to set all parameters to known values (the PRESET state) and is used as the common starting point for measurements in this manual. For a listing of the PRESET state parameter values, see **INSTRUMENT PRESET** in the **REFERENCE** section.
-

Note



The PRESET state depends on whether an HP 35677A/B S-Parameter Test Set is connected to the HP 3577A. Making the connection without turning off power to the HP 3577A Network Analyzer, requires pressing **INSTR PRESET** to update the starting parameter values.

2. The recommended sequence for setting up a measurement is
 - **INPUT**
 - **DISPLAY FCTN**
 - **FREQ**
 - **AMPTD**

This sequence is a good, general start for setting up an instrument state and should be easy to remember. See the circled numbers in figure 1-1.

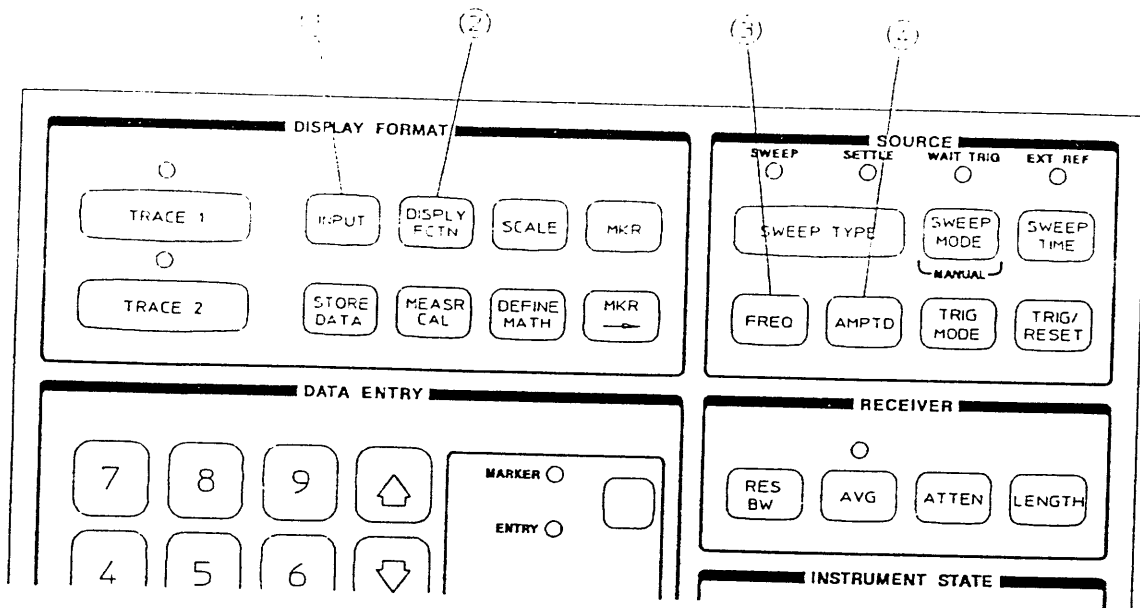

Figure 1-1. Set-UP Sequence

3. The HP 3577A is a menu-driven instrument. The hardkeys (all keys with a function stenciled on them) are used to display the various menus. If the menu displayed is not what you wanted, press another hardkey to display another menu. If you decide not to make a data entry after beginning the entry on the numeric keypad, you may press another hardkey to exit. Since data entries must be terminated by selection of units (Hz, dBm, etc.) no entry is made if units are not selected.
4. The softkey labels will appear next to the eight softkeys, along the right-hand side of the display screen. Each group of softkey labels is referred to as a "menu."
5. The beeper will sound to attract the user's attention when the HP 3577A displays a new screen message unless the beeper has been turned off; (see SPECIAL FUNCTIONS in the REFERENCE chapter).
6. If the HP 3577A is used as part of a measurement system, it is recommended that the frequency references of all instruments be phase-locked to a common frequency standard. The HP 3577A will lock to a frequency reference applied to its External Reference Input if the signal is between -7 and $+15$ dBm and the frequency is the result of dividing 10 MHz by an integer and is above ≥ 100 kHz (± 20 ppm). The HP 3577A can serve as the system reference via its 10 MHz, 0 dBm Reference Output. Both of these connections are located on the rear panel. If the HP 3577A is used as the standard, the stability will be .05 ppm per °C.
7. The HP 3577A requires 60 minutes warm up time before all of the specifications will apply; however, the instrument is operable during this warm-up period.

In Case of Trouble

8. If the HP 3577A fails to respond to front panel key presses, perform the following steps until normal operation is restored:
 - a. Verify that the HP-IB status indicator LED labeled "REMOTE" is not illuminated. It is possible that the instrument has been addressed over the bus, in which case it will not respond to front panel operation until LOCAL control is restored by pressing the **LCL** hardkey or via a controller issued command. The **LCL** key will not restore LOCAL status if the controller has issued a LOCAL LOCKOUT command.
 - b. Press **INSTR PRESET**.
 - c. Turn the HP 3577A power OFF and back ON.

Caution



The test described in the following step will erase the contents of all nonvolatile read/write memory on the main processor board. This resets all six instrument states, plot parameters, and the HP-IB parameters to their default parameters.

- d. If none of the previous steps have returned control to the front panel:
 - Turn power OFF
 - Hold down **SAVE** and **RECALL** simultaneously
 - Turn power ON

Continue to hold the keys down until all power-on tests are complete. This procedure will test parts of the main processor memory not normally tested and may reset a bad memory register, allowing normal operation to continue.

- e. Contact an authorized repair facility.

Confidence Test

After unpacking the instrument or whenever a quick check of basic operation is necessary, run the confidence test using the following keystrokes.

Key	Description
SPCL FCTN	Hardkey in the INSTRUMENT STATE section used to display the SPECIAL FUNCTION menu. This menu contains the softkey, CONF TEST.
CONF TEST	This selects the confidence test. Note that the screen displays a message to connect a cable between the output and the input to be tested. The menu contains commands to test any of the inputs. Connect the cable as shown below.

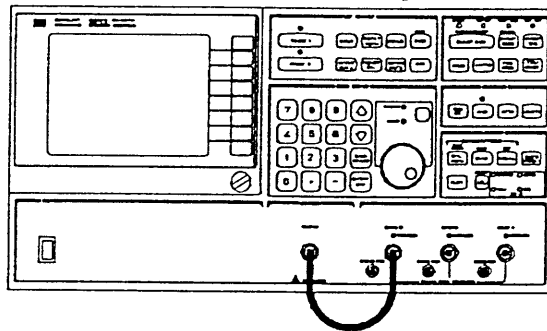

TEST R Softkey that begins test of input R.

The HP 3577A will run nine tests and display pass/fail results of each. These tests are:

- Log Sweep signal level test
- Log Sweep flatness test
- Linear Sweep signal level
- Linear Sweep magnitude flatness
- Synthesizer and L.O. feed through
- Amplitude Sweep accuracy
- Output limiter linearity
- Receiver Impedance
- Receiver Attenuator

If any tests fail, the HP 3577A Network Analyzer will stop the testing and display a failure message. Testing may be continued by pressing the CONTINUE TEST key. Any screen listing of a failed test will be bright.

Getting Started
Confidence Test

Inputs A and B may be tested in the same manner by connecting the source OUTPUT to the receiver input to be tested and pressing the corresponding softkey. When testing is complete, press **INSTR PRESET** or any other hardkey to exit the **CONF TEST** menu and begin a measurement setup.

Note



If any of the HP 3577A CONFIDENCE TESTS fail, refer to the HP 3577A Service Manual for instructions.

Warning



Service procedures should only be executed by trained service personnel, only. To avoid electrical shock, do not perform any servicing procedures unless qualified to do so.

Chapter 2

Making Measurements

Making Measurements

This section contains step by step instructions demonstrating the use of the HP 3577A Network Analyzer and the HP 35677A/B S-Parameter Test Set to make measurements.

Using the HP 3577A by itself, characterize:

1. A tuned stub notch filter
 - a. Measurement set up
 - b. Using the marker to make measurements
 - c. STORE trace data
 - d. SAVE Instrument State
2. A bandpass filter
 - a. Measurement set up
 - b. Measure -60 dB and -3 dB bandwidths (calculate shape factor)
 - c. Measure passband ripple
 - d. Measure passband insertion phase
 - e. Measure passband group delay
3. Gain compression of an amplifier
 - a. Measurement set up
 - b. Measure -3 dB gain compression point

Using the HP 35677A/B S-Parameter Test Set with the HP 3577A, characterize:

4. A low pass filter
 - a. Measurement set up
 - b. Measure insertion loss
 - c. Measure passband insertion phase
 - d. Measure passband ripple

5. S-parameters of an amplifier
 - a. Initial measurement set up
 - b. Measure S_{21}' forward gain and phase
 - c. Measure S_{12}' reverse loss
 - d. Measure S_{11}' return loss
 - e. Measure S_{22}' output reflection coefficient
 - f. Conversion of reflection coefficient to complex impedance

This list of measurements was selected to cover topics of general interest and common usage such that most of the capabilities of the HP 3577A Network Analyzer and HP 35677A/B S-Parameter Test Set are demonstrated. For details on operating features see the REFERENCE section. The listing of the hardkeys in the REFERENCE section is alphabetical.

As you read this section press the keys on the HP 3577A listed at the left of each page. Even if nothing is connected to be tested, references to menus and data entry exercises will help you learn to operate the HP 3577A Network Analyzer. It is important to start each topic at the beginning (i.e., at **INSTRUMENT PRESET**).

Note that most hardkeys are used only to display a menu of softkey labels. If a mistake is made in data entry or feature selection for data entry (such as forgetting to select **CENTER FREQ** before beginning to enter it), pressing the hardkey again will display the original menu.

Tuned Stub Notch Filter

Connect the cables and adapters as shown in figure 2-1. This configuration should result in a notch filter whose center frequency is related to the length of the open-ended cable. The notch filter is constructed from the following parts:

Qty	Description	HP Part Number
2	N(m) to BNC(f) adapters	1250-0780
2	1 foot BNC cable	8120-1838
1	BNC tee (f)(f)(m)	1250-0781
1	BNC(f) to BNC(f) adapter	1250-0080
1	2 foot BNC cable	8120-1839

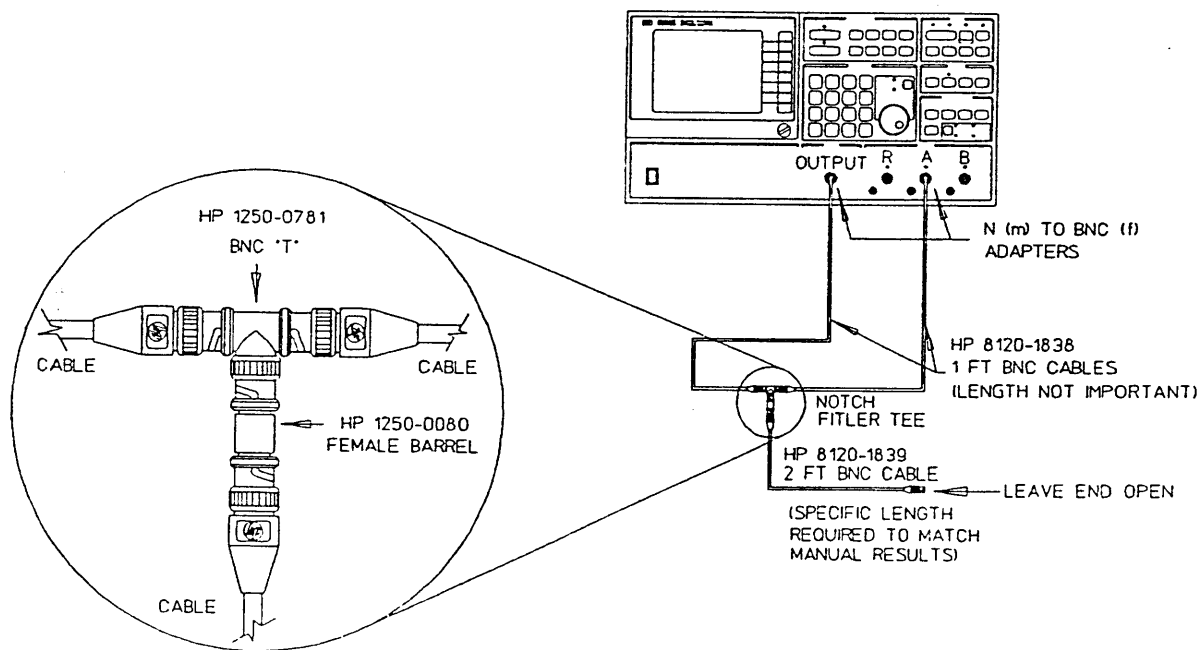

Figure 2-1. Circuit Configuration

Making Measurements
Tuned Stub Notch Filter

This measurement exercise is designed to show:

1. How to set up the instrument state to make a measurement.
2. How to use the markers to make measurements.
3. How to STORE trace data.
4. How to SAVE an instrument state.

Data entries require four steps: press a hardkey to display a menu, press a softkey (if not already active or bright) to select the parameter for data entry, enter data with the numeric key pad, and press a softkey to select units. If the knob or arrow keys are used, unit selection is not necessary; since existing values are modified, units do not change.

Any of the three receiver inputs may be used for this example. If the operator wishes to use an input other than R (the default input definition), connection should be made to that input and the corresponding selection should be made in the **INPUT** menu. Note that "receiver input" refers to front panel connections R, A, and B while "**INPUT**" refers to the definition of the screen trace under the **INPUT** hardkey.

This measurement setup begins, after INSTRUMENT PRESET, by defining **INPUT**, **DISPLAY FUNCTION**, **FREQUENCY**, and **AMPLITUDE**.

Measurement Set Up

Key	Description
INSTR PRESET	This green hardkey in the INSTRUMENT STATE section of the front panel presets HP3577A parameters to their default values. These are listed under INSTRUMENT PRESET in the REFERENCE section of this manual. Note that the INPUT menu is displayed.

A Softkey used to select receiver input A as the **INPUT** definition for the active trace. Note that the LED above the **TRACE 1** hardkey is illuminated, indicating that trace one is active. The screen should now appear as shown in figure 2-2

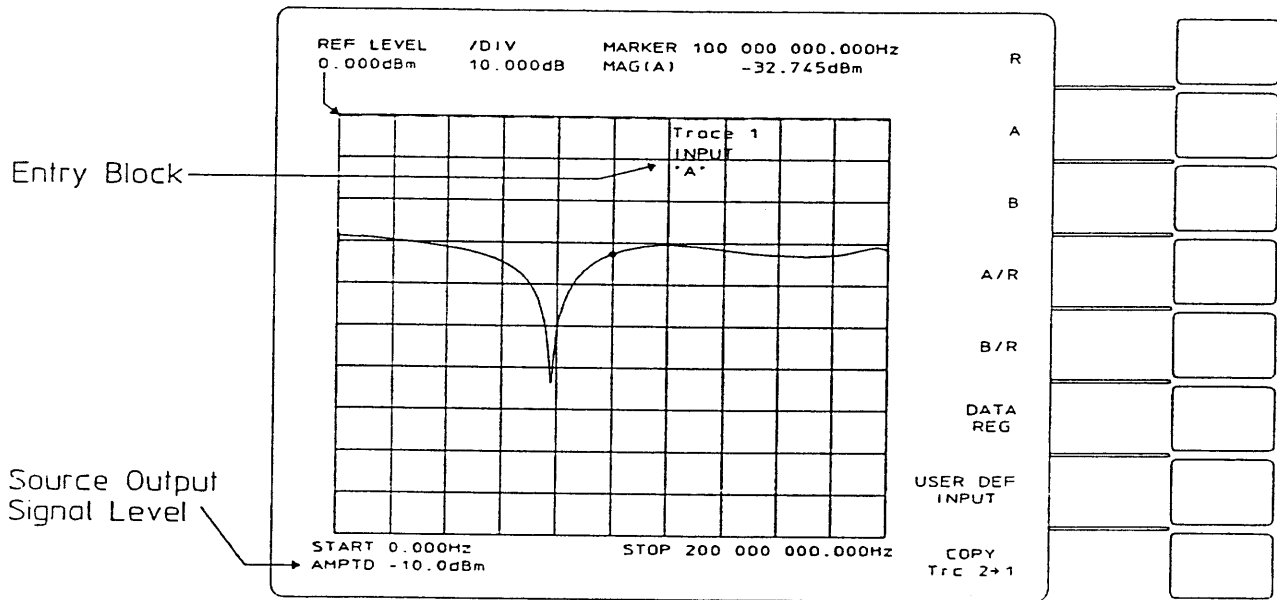

Figure 2-2. Log Magnitude of Input A

Key	Description
TRACE 2	Hardkey in the DISPLAY FORMAT section that selects trace two as the active trace. Note that the INPUT menu shows that INPUT R is active for trace two. Note that trace one and its alphanumeric information above the graticule dimmed slightly when trace two was selected.
A	Softkey that selects receiver input A as the active input for trace two. When this key was pressed the beeper sounded and the screen message "WARNING: TRACE IS OFF" appeared.
DISP FCTN	Hardkey in the DISPLAY FORMAT section that displays a new menu listing the seven possible display function formats available for each trace. Note that trace two is OFF.
PHASE	Softkey used to select the phase display function for the active trace. Pressing this key turns trace two on and defines its display function to be phase. Note that trace two is brighter than trace one. This difference in trace intensity and the LEDs above the TRACE hardkeys indicate which trace is active. Any softkey commands given or data entered will affect the active trace. Note that when trace two was turned on another set of alphanumeric information appeared above the graticule. This information applies to trace two and is the same intensity as the trace.

The screen should now appear as shown in figure 2-3

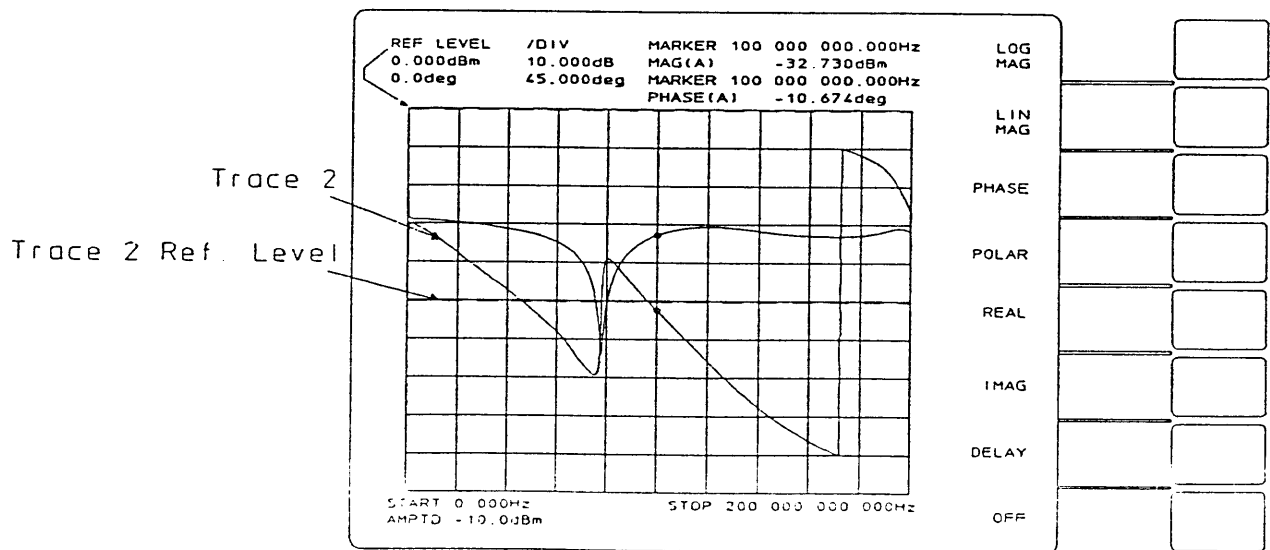

Figure 2-3. Log Magnitude and Phase of Input A

<i>Key</i>	<i>Description</i>
FREQ	Hardkey in the SOURCE section used to display the FREQUENCY menu. Note that the softkey label START FREQ is active. Since this is the parameter to be modified, selection of a softkey parameter is not necessary.
1	Data entry done with the numeric key pad in the DATA ENTRY section.
MHz	Softkey used to select units for the data entry.
STOP FREQ	Softkey used to select the stop frequency parameter for modification or data entry of a new value.
1 5 0	Data entry done with the numeric key pad in the DATA ENTRY section.
MHz	Softkey used to select units for the data entry.

Key	Description
AMPTD	Hardkey in the SOURCE section used to display the AMPLITUDE menu. Note that the softkey label AMPTD is active. Since this is the parameter to be modified, selection of a softkey parameter is not necessary. Note that the ENTRY BLOCK shows the current value of this parameter is - 10 dBm.
↓	Down arrow key in the DATA ENTRY section used to decrement the active parameter by the STEP SIZE. Note that the value in the ENTRY BLOCK and the alphanumeric at the lower left corner of the graticule show that the source amplitude is now - 11 dBm (i.e. STEP SIZE is 1 dB).
TRACE 1	Hardkey in the DISPLAY FORMAT section that selects trace one as the active trace.
SCALE	Hardkey in the DISPLAY FORMAT section that displays the scale parameter menu.
AUTO SCALE	Softkey selection that selects scale parameters such that the active trace will fit in the graticule. The screen should now appear as shown in figure 2-4.

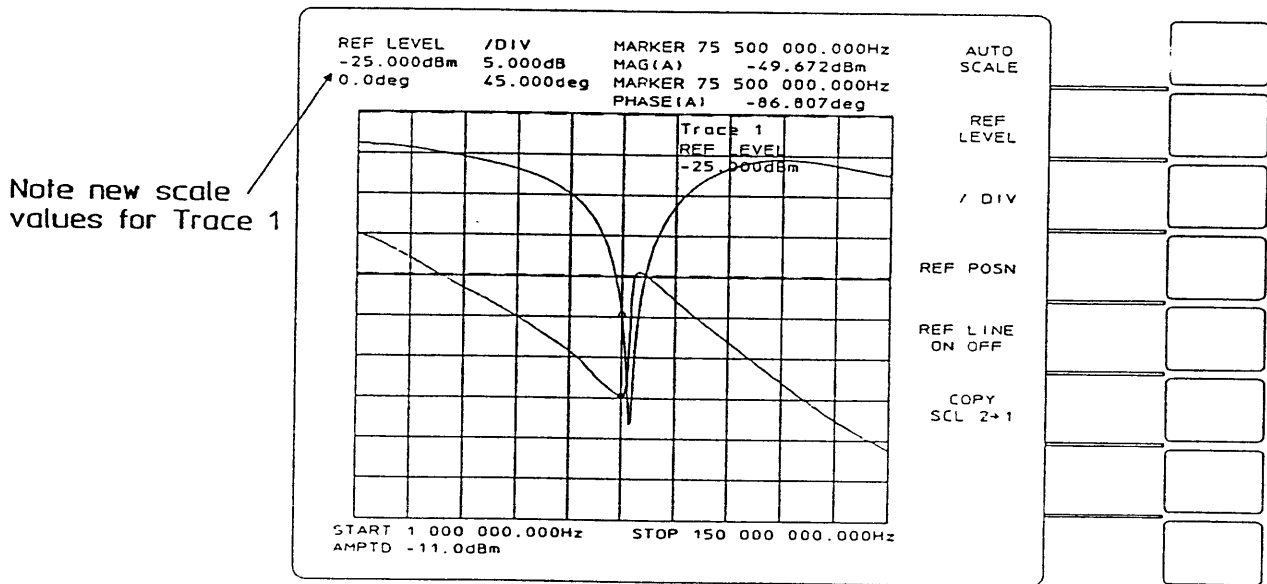

Figure 2-4. Changing Source and Scale Parameter Value

Now the measurement set up is complete. Next we begin to take measurements.

Making Measurements

<i>Key</i>	<i>Description</i>
RPG KNOB	The knob in the DATA ENTRY section should be in the MARKER mode (indicated by the LEDs above the knob and changed to modify data in the ENTRY mode with the key next to the LEDs). Turn the knob and notice that the markers move along the traces and the change in information display in the marker information block. Position the markers at the extreme left of the graticule.
MKR	Hardkey in the DISPLAY FORMAT section used to display the MARKER menu.
ZERO MARKER	Softkey used to turn on the OFFSET MARKER feature and set the MARKER OFFSET (which is a magnitude in this case) and FREQ OFFSET values to those of the regular marker. Note that a triangular marker appears on top of the circular marker on trace one. This offset marker is now the reference for measurements taken with the marker on trace one. Note the change in the marker information block for trace one from "MARKER" to "OFFSET."
MKR →	Hardkey in the DISPLAY FORMAT section used to display the MARKER GOES INTO... menu. These keys may be used to make data entries with the marker after positioning it with the knob or to move the marker to maximum or minimum points on the trace.
MARKER SEARCH	Softkey used to display the MARKER SEARCH menu, which is a second level menu. Note that MARKER TARGET is the active (bright) softkey label and that its default value is -3.000 dB.
MKR → R TARG	Softkey used to search right for target value. Note that the regular marker on trace two moves right until it reaches the first point on the trace where it is three dB below the OFFSET MARKER.

Making Measurements
 Making Measurements

Key	Description
MKR	Hardkey described previously.
ZERO MARKER	Softkey described previously. Note that the offset marker moves to the position of the regular marker.
MKR →	Hardkey described previously.
MARKER SEARCH	Softkey described previously.
0	Data entry for a new marker target value.
dB	Softkey selection of units for the new marker target value.
MKR → R TARG	Softkey used to search right for target value. The MARKER information block now shows the 3 dB width of the notch filter as shown in figure 2-5.

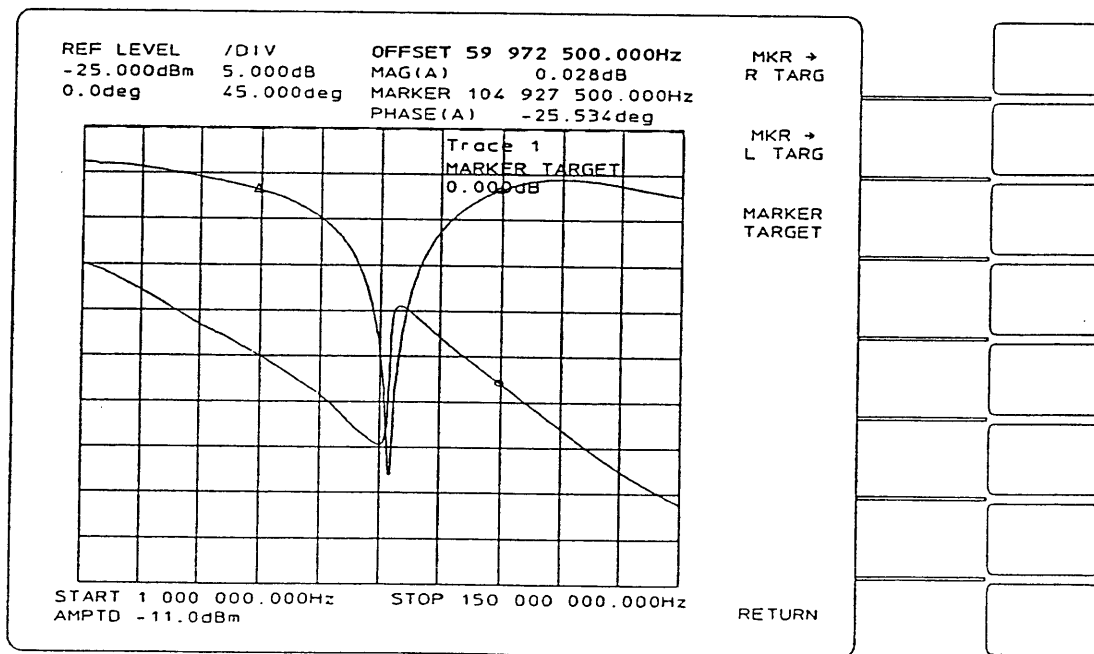

Figure 2-5. 3dB Width

Key	Description
MKR	Hardkey described previously.
MKR OFST ON OFF	Softkey used to turn offset marker on or off. This is a push-push toggle type key; continued key presses will toggle the feature between on and off. One keypress now turns it off. Note the return of the marker information block to marker.
MKR →	Hardkey described previously.
MKR → MIN	Softkey used to move the marker to the lowest value on the trace. This point is the center frequency of the notch. Note that the marker information block now contains the notch center frequency and rejection magnitude as shown in figure 2-6.

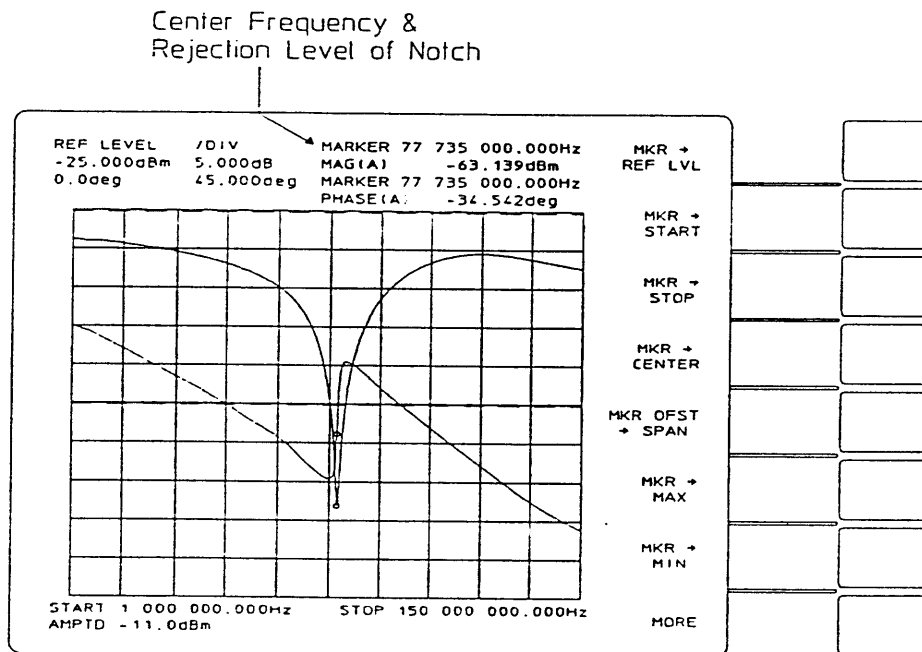
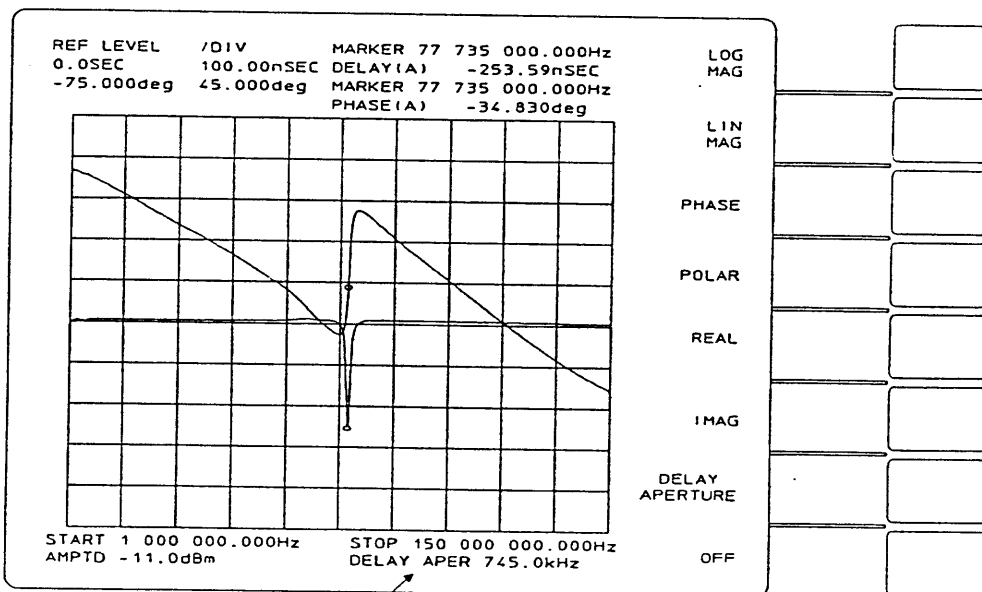

Figure 2-6. Notch Center Frequency

Key	Description
TRACE 2	Hardkey described previously.
SCALE	Hardkey described previously.
- 1 6 0	Data entry.
deg	Softkey selection of units.
TRACE 1	Hardkey in the DISPLAY FORMAT section.
DISPLY FCTN	Hardkey in the DISPLAY FORMAT section used to display the DISPLAY FUNCTION menu.
DELAY	Softkey selection of group delay as the display function for the active trace. Note that this softkey label changes to read DELAY APERTURE when pressed. Also note the DELAY APER alphanumeric data under the lower right corner of the graticule. See figure 2-7.



Corresponds to % of Span Selected for Aperture

Figure 2-7. Phase and Group Delay

Key	Description
DELAY APERTURE	Softkey used to display the menu of user selectable values for the delay aperture. These value's units are frequency in percent-of-span. Data entries are not allowed for this parameter.
1 % OF SPAN	Softkey used to select a delay aperture that is 1% of the total frequency span swept.
DISPLY FCTN	Hardkey described previously.
POLAR	Softkey used to select POLAR as the display function for the active trace. Since only one trace is allowed in POLAR display function, the inactive trace will be turned off.
SCALE	Hardkey described previously.
AUTO SCALE	Softkey described previously. See figure 2-8.

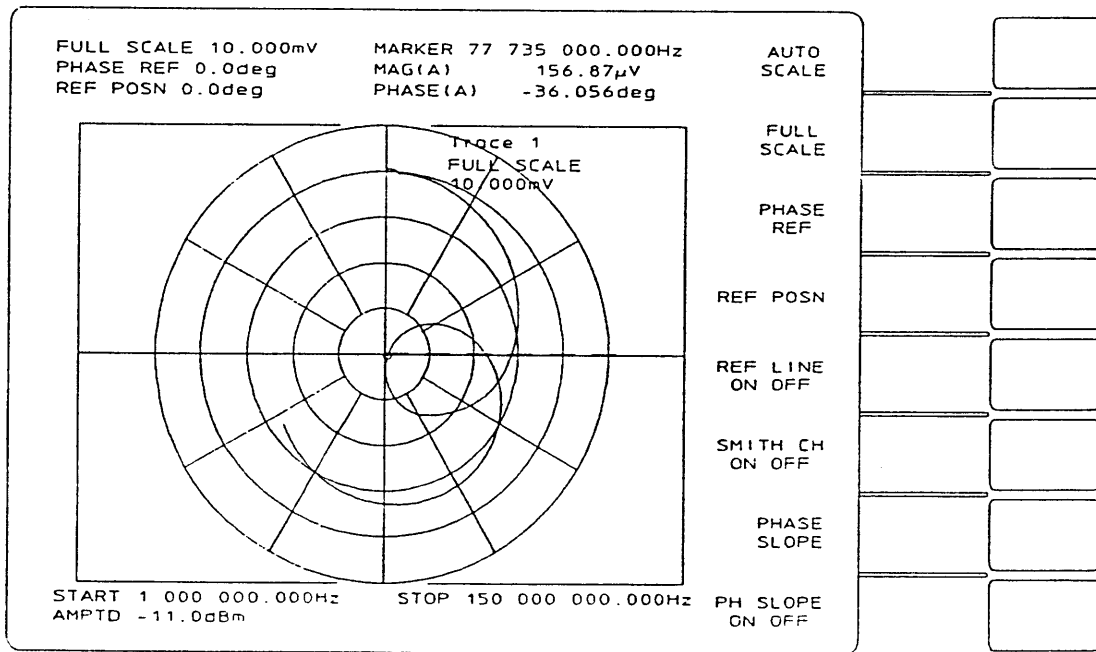

Figure 2-8. Polar Display Function

Now the measurements are complete. Next, we will STORE the trace data in one of four data storage registers.

Store Trace Data

Key

Description

STORE
DATA

Hardkey in the DISPLAY FORMAT section used to display the store menu.
The menu should appear as shown in figure 2-9.

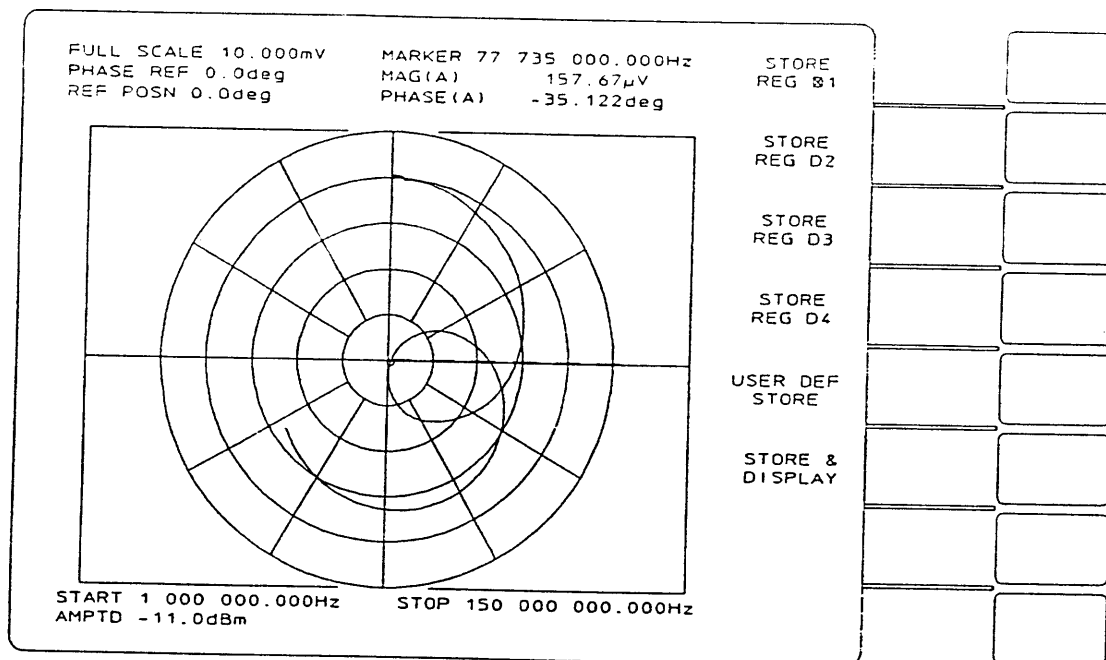

Figure 2-9. Store Data Menu

Key	Description
STORE REG D1	Softkey used to store the trace data of the active trace as defined under the INPUT key into data register D1. Since the INPUT of both traces is defined to be A, it didn't matter which trace was active. The current display function has no effect on what is stored. Note the screen message "STORE completed."
INPUT	Hardkey in the DISPLAY FORMAT section. We're going to display the data register we just stored data in.
DATA REG	Softkey used to specify that the INPUT definition is a data register.
D1	Softkey used to specify which data register is displayed. Note that a sweep dot still appears. Memory sweeps are still occurring but no new measurement is being displayed. <i>If new START and STOP frequencies are entered, this trace will not change.</i>
DISPLY FCTN	Hardkey in the DISPLAY FORMAT section. Trace data may be represented in any of the seven display functions.
LIN MAG	Any softkey in this menu may be selected to redefine the display function for the trace showing data stored in the data registers.

Save Instrument State

Key	Description
SAVE	Hardkey in the INSTRUMENT STATE section used to display the menu used to save the instrument state into one of five state registers. This menu will appear as shown in figure 2-10.
SAVE REG 1	Softkey selection of instrument state register one. Note screen message "INSTRUMENT STATE SAVED." This state may be recalled by pressing the RECALL hardkey and then pressing the RECALL REG 1 softkey. Cycling power or presetting the instrument will not affect this memory register.

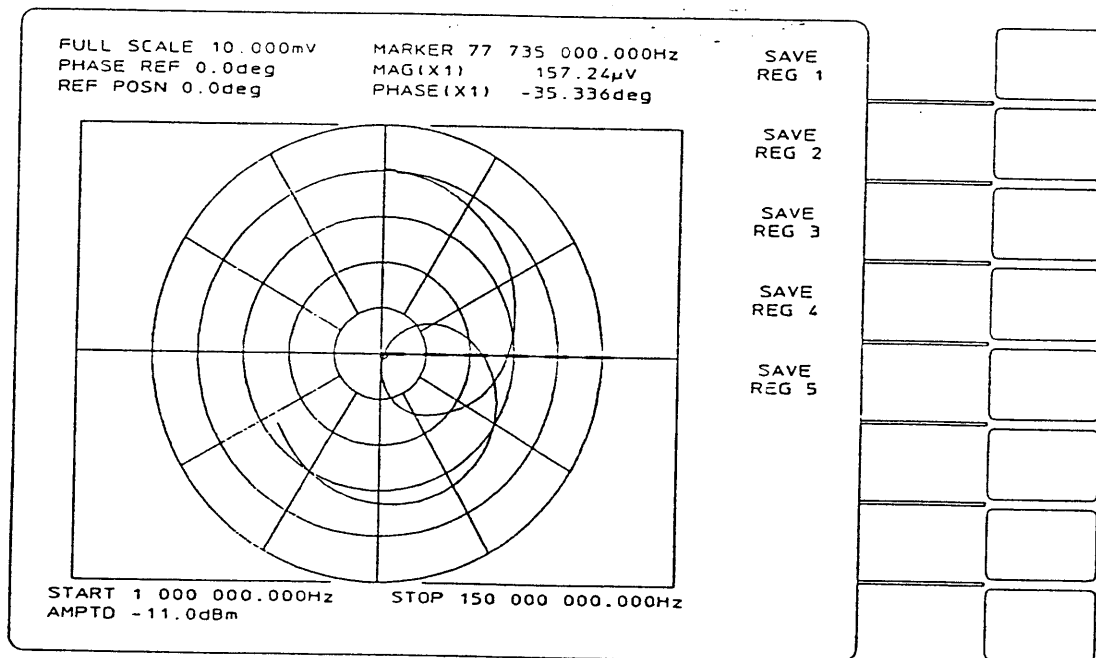

Figure 2-10. Save Instrument State Menu

Bandpass Filter

Connect the filter to the HP 3577A as shown in figure 2-11. The bandpass filter used in this example has a center frequency of 70 MHz but the process is the same for any bandpass filter.

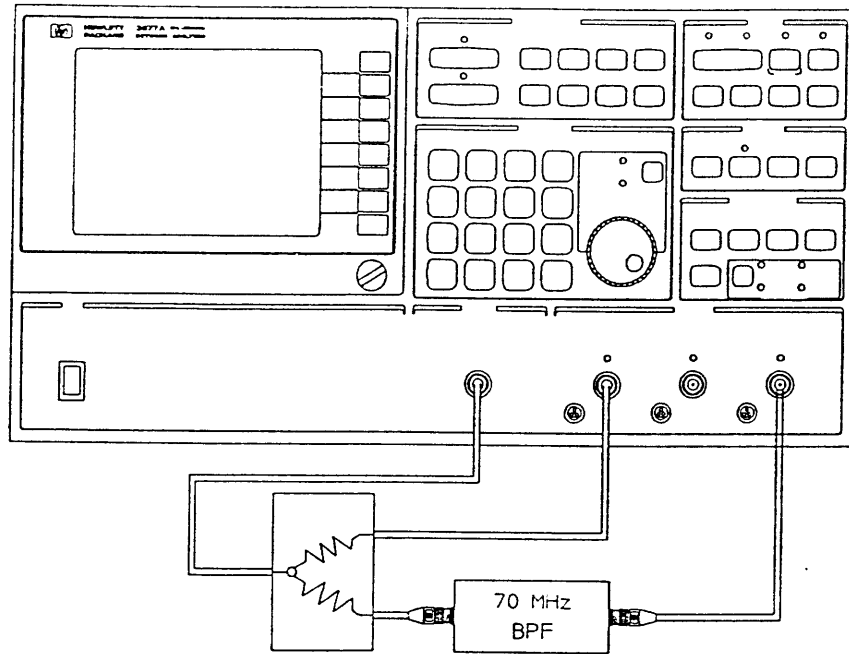

Figure 2-11.

The purpose of this measurement exercise is to demonstrate the use of the HP 3577A Network Analyzer to characterize a bandpass filter. The general organization is:

1. Set up the measurement
2. Measure the -60 dB and -3 dB bandwidths (calculate the shape factor)
3. Measure the passband ripple
4. Measure the passband insertion phase
5. Measure the passband group delay

Making Measurements
Bandpass Filter

This measurement set up begins, after **INSTRUMENT PRESET**, with the four hardkeys:

INPUT
DISPLY FCTN
FREQ
AMPTD

This set up will be

INPUT = B/R
DISPLAY FUNCTION = LOG MAG
CENTER FREQ = 70 MHz
FREQ SPAN = 100 kHz

(equivalent to setting
START FREQ = 69.95 MHz
STOP FREQ = 70.05 MHz)

AMPLITUDE = 0 dBm.

Measurement Set Up

Key	Description
INSTR PRESET	This green hardkey, in the INSTRUMENT STATE section, is used to preset the HP 3577A parameters to their default values. These are listed under INSTRUMENT PRESET in the REFERENCE section. Note that the INPUT menu is displayed when the HP 3577A is PRESET. See figure 2-12 and the screen of the HP 3577A. If the INPUT hardkey is pressed the menu will not change.
B/R	Softkey used to change the INPUT definition to B/R.
DISPLY FCTN	Hardkey in the DISPLAY FORMAT section. Note the new menu. These softkeys are the seven (eight, counting OFF) ways that the measurement data will be interpreted by the HP 3577A. Note that the current (and default) DISPLAY FUNCTION is Log Magnitude. Make no change in this menu.

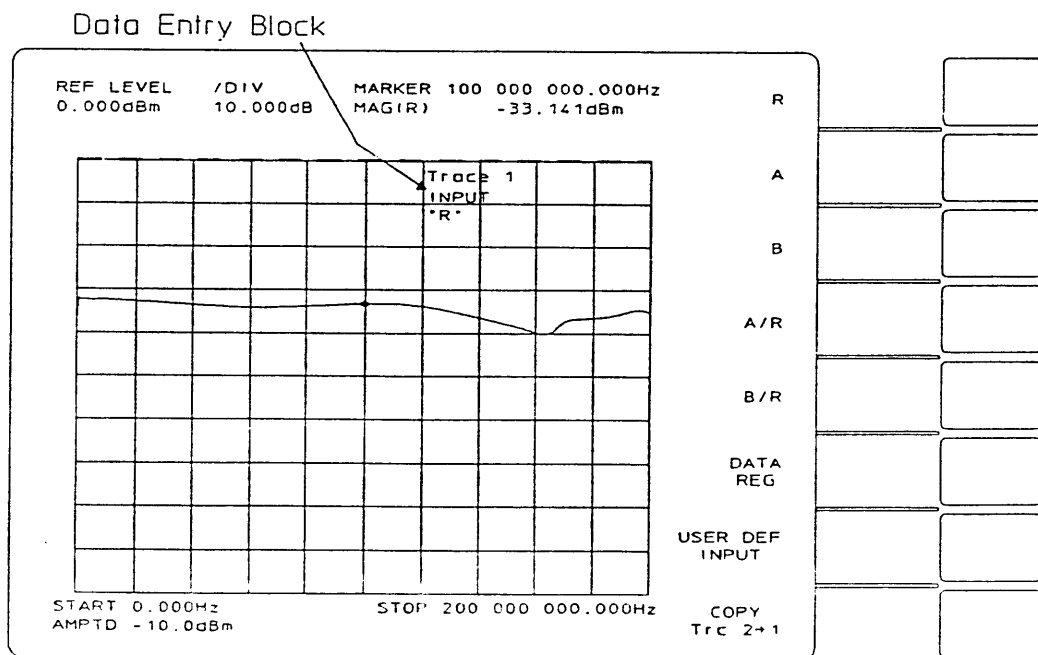

Figure 2-12. Default Menu

Making Measurements
Measurement Set Up

Key	Description
FREQ	Hardkey in the SOURCE section used to display the menu of softkeys shown in figure 2-13.
CENTER FREQ	Softkey used to select center frequency as the parameter for modification. Default value is 100 MHz.
7 0	Data entry
MHZ	Softkey used to select megahertz as the units for the data entry. Note that the data entry is not complete until units are selected from the menu.
FREQ SPAN	Softkey used to select frequency span as the parameter for modification. The data entry block (on the screen) shows the current value is 200 MHz.
1 0 0	Data entry
KHZ	Softkey used to select kHz as units for entry.
AMPTD	Hardkey in the SOURCE section used to display the menu of softkeys shown in figure 2-14. Default value is - 10 dBm without the test set and +15 dBm with the test set.
0	Data entry
dBm	Softkey used to select the units for the data entry. The entry is complete when this key is pressed.

Start Frequency Active

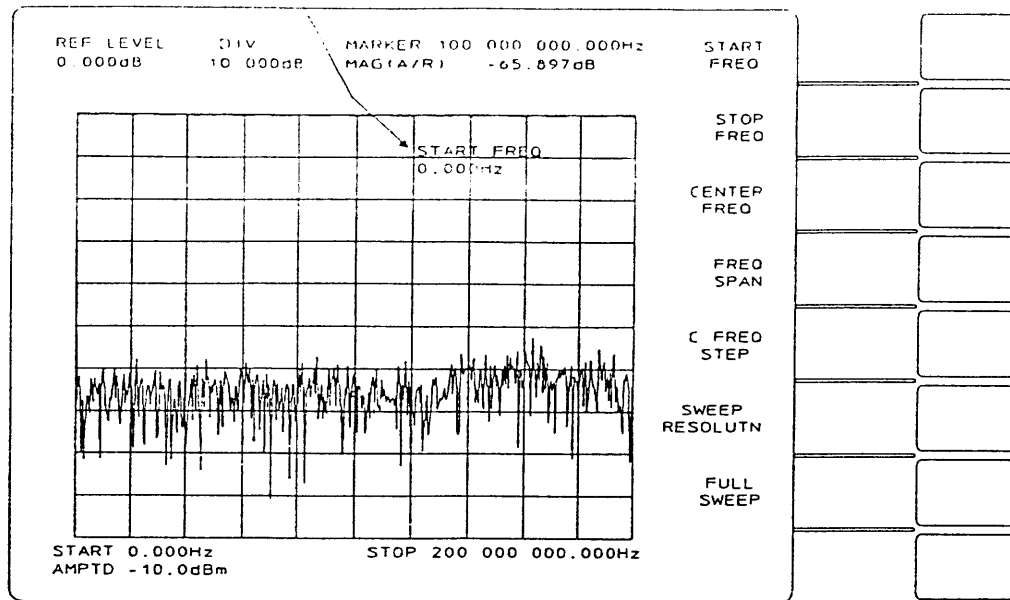

Figure 2-13. The Frequency Menu

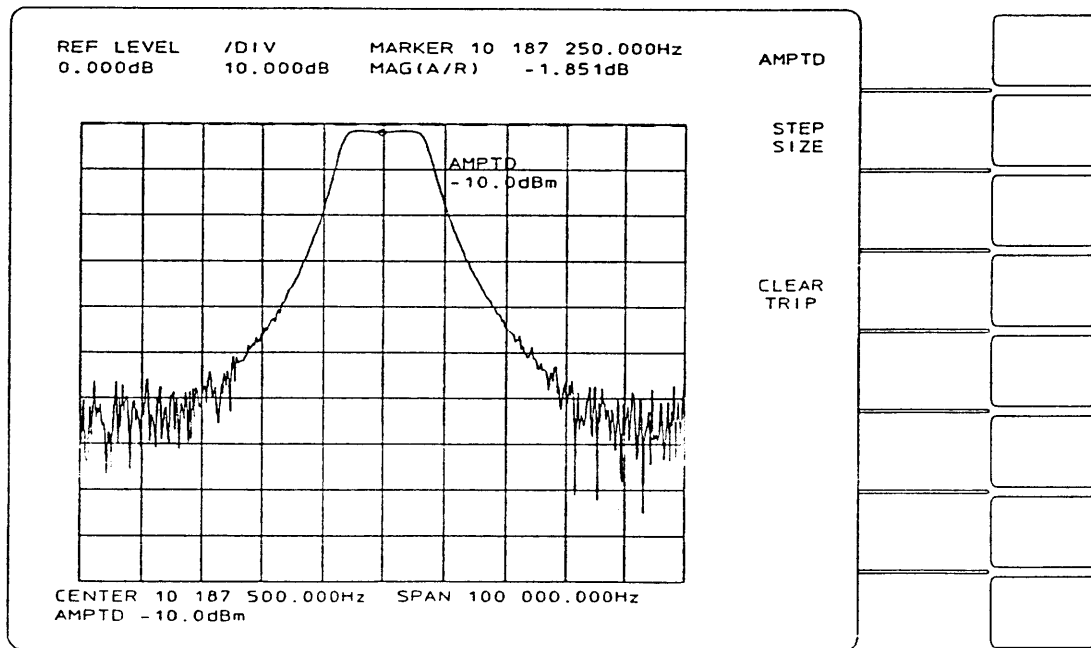

Figure 2-14. The Source Amplitude Menu

Making Measurements
Measurement Set Up

In this case, increasing the source amplitude 10 dB has decreased the noise level in the stopband by the same amount. Noise may be reduced further by using higher source amplitudes and/or selecting a receiver attenuation of 0 dB, as long as the input is not overdriven in the passband. Before removing the 20 dB receiver attenuator from input B, check for a maximum signal level of > -20 dBm on input B by pressing:

1. Hardkey **INPUT**
2. Softkey **B**
3. Hardkey **MKR** →
4. Softkey **MKR**→ max, read level in marker info block at top of screen

Change the input definition back to B/R by pressing:

1. Hardkey **INPUT**
2. Softkey **B/R**

Select 0 dB attenuation by pressing:

1. Hardkey **ATTEN**
2. Softkey **ATTEN B 0dB 20dB**

These steps were taken and the results appear in figure 2-15 for comparison with figure 2-14.

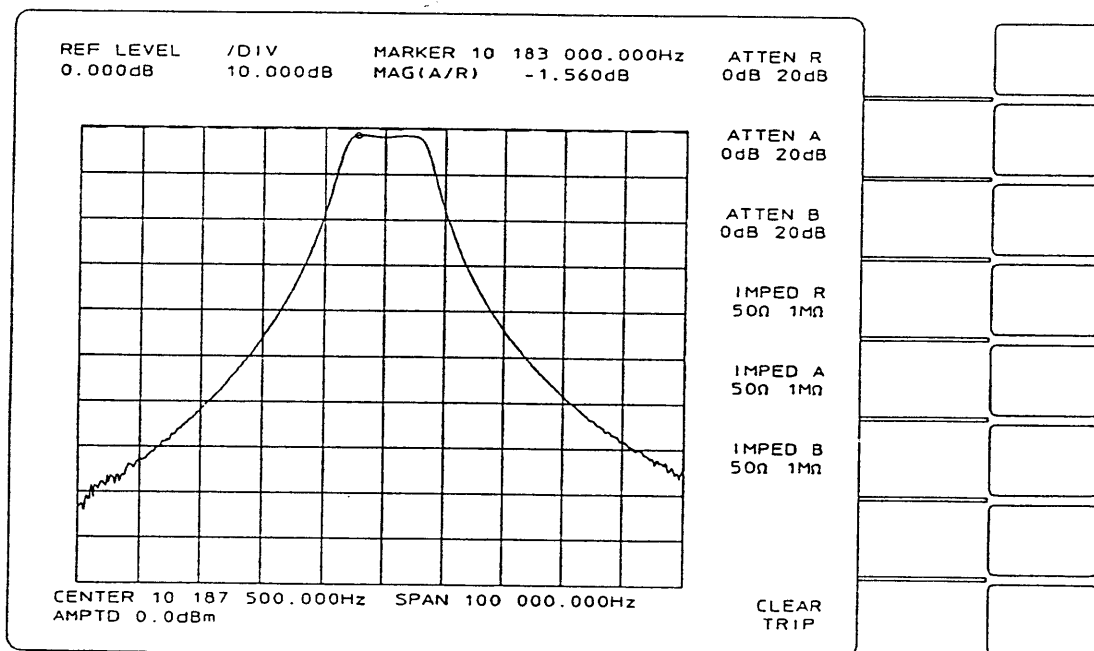

Figure 2-15. Optimizing Dynamic Range

<i>Key</i>	<i>Description</i>
RES BW	Hardkey in the RECEIVER section used to display the four possible selections for resolution bandwidth. Note that the current selection is 1 kHz.
100 Hz	Softkey used to select a resolution bandwidth of 100 Hz.
SWEEP TIME	Hardkey in the SOURCE section used to select a new sweep time. Any time the resolution bandwidth is reduced, an increase in sweep time may be required. See OPTIMIZING SWEEP TIME in Appendix A.
5	Data entry.
SEC	Softkey used to select units for the data entry.
MEASR CAL	Hardkey in the DISPLAY FORMAT section used to display a menu listing the HP 3577A calibration features.

Key	Description
USER ACTION	Replace the Device Under Test with a BNC barrel (BNC(f) to BNC(f) adapter) and wait for a complete sweep.
NORMLIZE	Softkey command used to normalize the measurement. When pressed, this softkey stores the active trace in a data register (D1 for trace one and D2 for trace two) and then redefines the INPUT to be the previous INPUT definition divided by the data register that was just used. Now the INPUT for trace one is B/R/D1 (press the INPUT hardkey to see it in the ENTRY BLOCK). See figure 2-16.
USER ACTION	Replace the BNC barrel with the bandpass filter.

Now the setup is complete and measurements can be made. Most measurements are made using the **MARKER**. This small circle may be moved along the trace in a number of ways, some of which will be demonstrated in the following steps.

UDF = A/R/D1

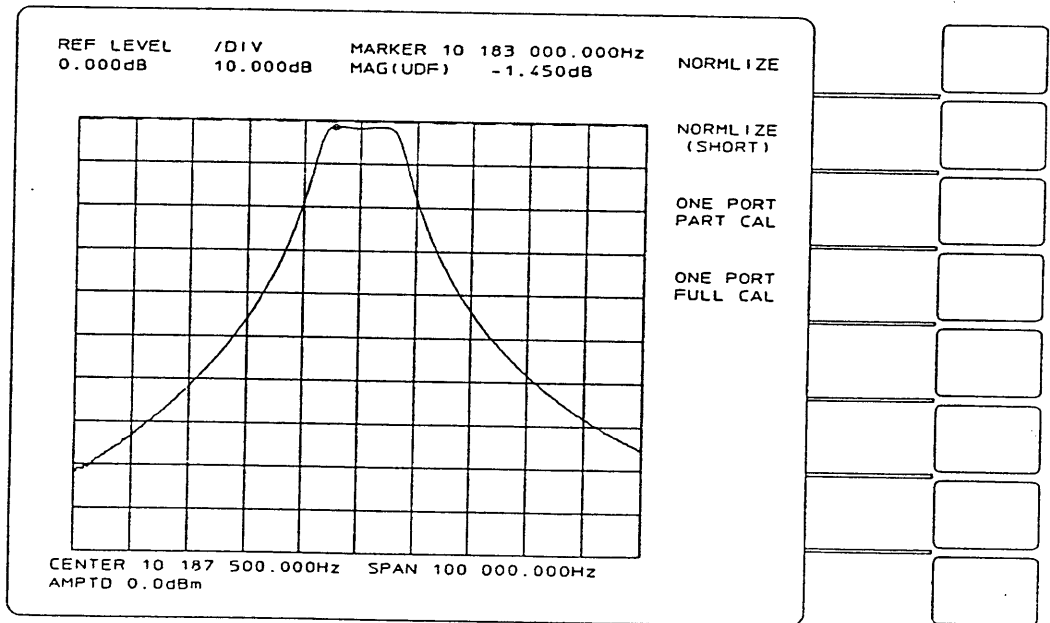

Figure 2-16. Normalized Bandpass Filter Response

Bandwidth Measurements

KEY	DESCRIPTION
RPG KNOB	Note that the marker dot appears at midscreen. The frequency in the Marker Information Block should be 70 MHz. If it is not, turn the knob until it is.
MKR	Hardkey in the display format used to display the MARKER menu of softkeys.
ZERO MARKER	Softkey used to turn on the offset marker. This triangle shaped marker will turn on with the same values as the regular marker (in this case, magnitude & frequency). Note that the marker information block above the graticule now shows OFFSET information. Note that the softkey MKR OFST ON/OFF shows the feature has been turned on. This toggle type softkey may be used to return the marker to normal operation (OFFSET OFF) by pressing it once.
MARKER OFFSET	Softkey used to display the magnitude value of the offset marker in the entry block. New values may be entered with the numeric key pad or the current value may be modified with the arrow keys or the knob in the ENTRY mode when this softkey label is active (bright). See figure 2-17.

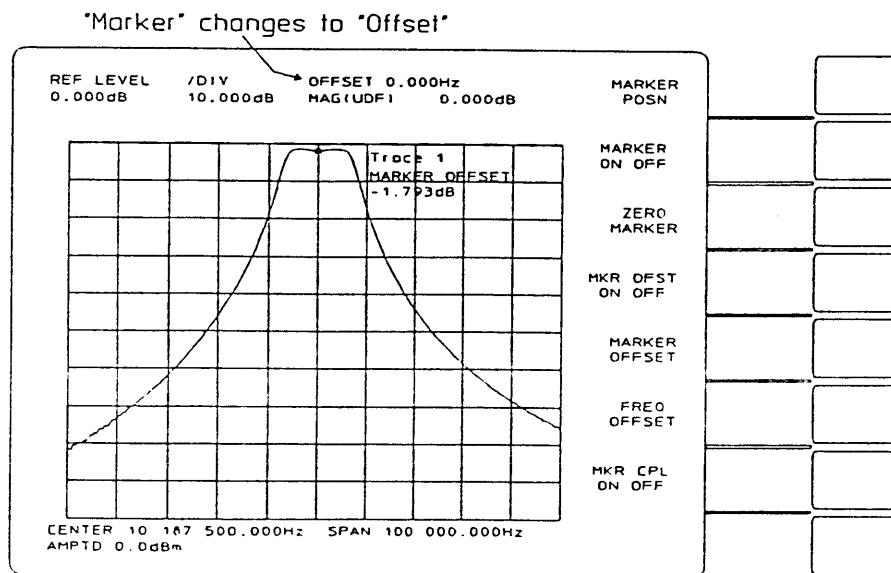

Figure 2-17. The Marker Menu

Making Measurements
Bandwidth Measurements

Key	Description
FREQ OFFSET	Softkey used to display the frequency value of the offset marker in the entry block. New values may be entered with the numeric key pad or the current value may be modified with the arrow keys or the knob in the ENTRY mode when this softkey label is bright.
SAVE	Hardkey in the INSTRUMENT STATE section used to display the SAVE STATE menu.
SAVE REG 1	Softkey used to save the current instrument state in the first of five registers. This state will be recalled to begin another measurement later in this exercise.
MKR →	Hardkey in the DISPLAY FORMAT section used to make data entries using the position of the marker. Also, → MAX, → MIN and MARKER SEARCH will move the marker to points of interest on the active trace.
MARKER SEARCH	Softkey that displays a second-level menu of softkeys used to search for specific values. Note that MARKER TARGET is active.
- 6 0	Data entry
dB	Softkey used to select units for MARKER TARGET.
MKR→ L TARG	Softkey used to search left for the user defined marker target value. See figure 2-18.

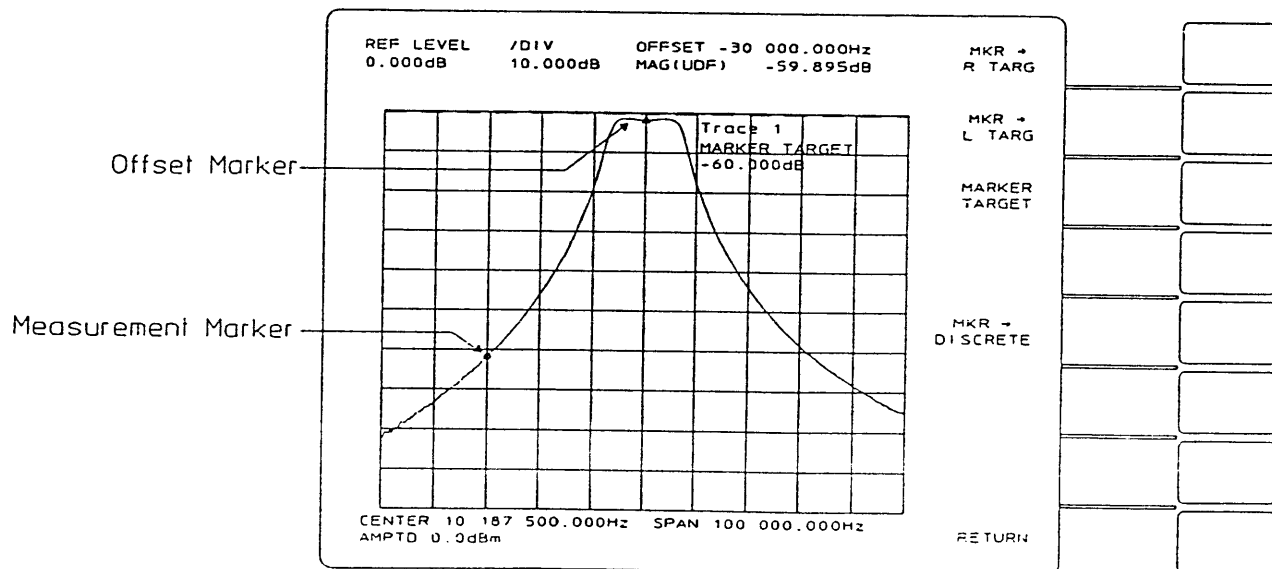

Figure 2-18. Marker Search

Key	Description
MKR	Hardkey in the DISPLAY FORMAT section.
ZERO MARKER	Softkey: moves the offset marker to the new marker position. This is in preparation for another marker search for a magnitude equal to the level at this marker position. The result will be the offset frequency (between the two markers).
MKR →	Hardkey in the DISPLAY FORMAT section.
MARKER SEARCH	Softkey described previously
0	Data entry for a new marker target value.
dB	Softkey selection of units.
MKR→ R TARG	Softkey used to search right for the user defined marker target value. The offset reading in the marker block is the 60 dB bandwidth for this bandpass filter. See figure 2-19.

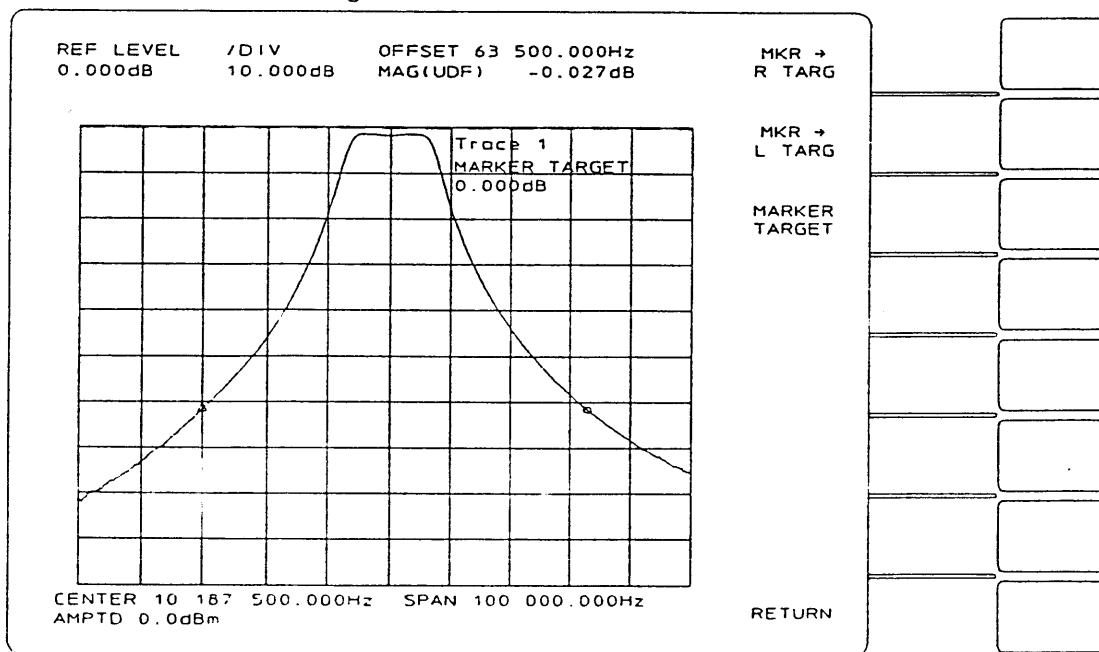

Figure 2-19. 60 dB Bandwidth

Making Measurements
Bandwidth Measurements

Key	Description
RECALL	Hardkey in the INSTRUMENT STATE section used to display a new menu.
RECALL REG 1	Softkey used to RECALL instrument state saved in register 1.
MKR →	Hardkey in the DISPLAY FORMAT section.
MARKER SEARCH	Hardkey described previously. Note that the target value has returned to - 3.000 dB as shown in the data entry block.
MKR → L TARG	Softkey used to search left for the marker target value.
MKR	Hardkey in the DISPLAY FORMAT section.
ZERO MARKER	Softkey used to move the offset marker to regular marker.
MKR →	Hardkey in the DISPLAY FORMAT section.
MARKER SEARCH	Softkey described previously.
0	Data entry.
dB	Softkey selection of units.
MKR → R TARG	Softkey: searches right for target value. The OFFSET information above the graticule contains the - 3 dB bandwidth for this filter. See figure 2-20. Shape factor may now be calculated.

Making Measurements
Bandwidth Measurements

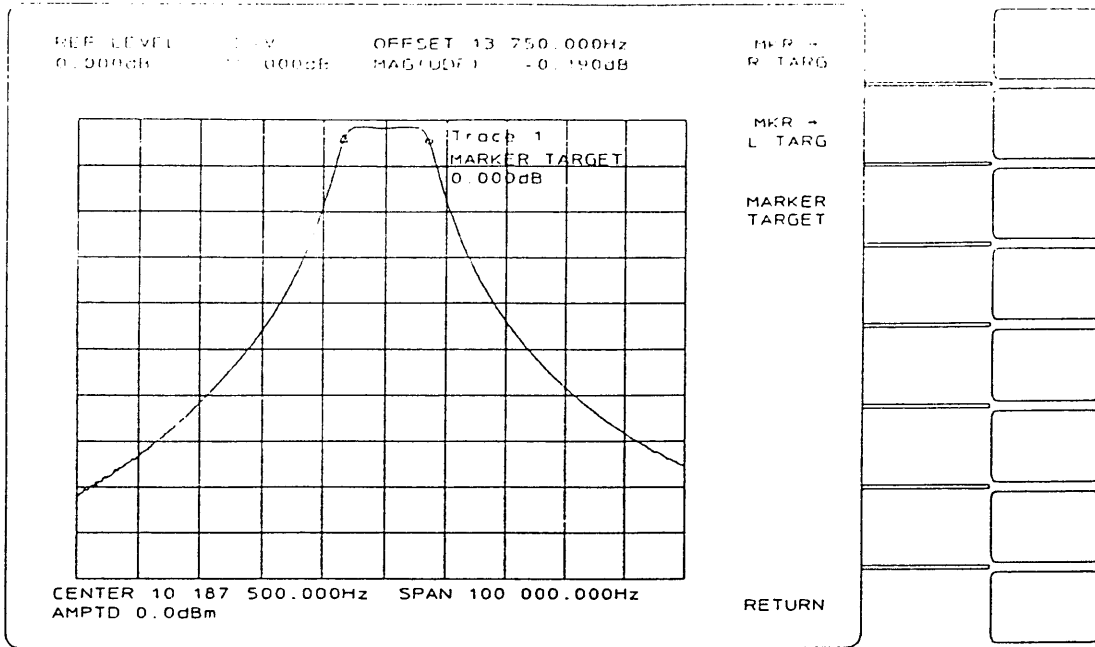

Figure 2-20. 3 dB Bandwidth

$$\text{Shape Factor} = \frac{-60 \text{ dB BW}}{-3 \text{ dB BW}} = \frac{63,500}{13,750} = 4.62$$

Passband Ripple

The next measurement is passband ripple. To make this measurement ALTERNATE SWEEP will be employed to retain the frequency span given to trace one while viewing a narrower span with trace two. When ALTERNATE SWEEP TYPE is selected, trace two starts out with preset values. This means another measurement set up is required for trace two, as follows:

KEY	DESCRIPTION
SWEEP TYPE	Hardkey in the SOURCE section used to display the menu of softkeys which select the type of sweep.
ALTERNATE SWEEP	Softkey used to select alternate sweep. This feature allows each trace to have different values for start & stop or center & span frequencies, amplitude, sweep time, and resolution bandwidth.
TRACE 2	Hardkey in the DISPLAY FORMAT section used to select trace two as the active trace.
INPUT	Hardkey in the DISPLAY FORMAT section.
B/R	Softkey used to select B/R as the input definition for the active trace. Note the warning message on the screen that this trace is off. Next we'll turn it on in the DISPLAY FUNCTION menu.
DISPLY FCTN	Hardkey in the DISPLAY FORMAT section used to select the DISPLAY FUNCTION of the active trace. Note that OFF is bright in the menu, indicating that trace two is off.
LOG MAG	Softkey used to select LOG MAGNITUDE as the display function for trace two, effectively turning the trace on. All parameters for trace two revert to default parameters including AMPTD = -10 dBm. Since AMPTD = 0 dBm for trace one, the HP 3577A will change the amplitude OUTPUT level at the beginning of each sweep. Note clicking of attenuator relays. The HP 3577A uses relays in the output attenuator circuit to set the output amplitude. If left running in a state that switches these relays regularly, the instrument will time out and switch to SINGLE SWEEP MODE after five minutes to reduce relay wear. See SWEEP MODE, SINGLE in the REFERENCE section.
AMPTD	Hardkey in the SOURCE section.
0	Data entry.

<i>Key</i>	<i>Description</i>
dBm	Softkey selection of units for the data entry. The clicking of the output attenuator relays will stop when the amplitudes of the two traces are set equal.
FREQ	Hardkey in the SOURCE section.
CENTER FREQ	Softkey used to select the center frequency parameter for data entry.
7 0	Data entry.
MHz	Softkey selection of units.
FREQ SPAN	Softkey used to select the frequency span parameter for data entry.
7 . 3 2 5	Data entry that is the center portion of the - 3 dB bandwidth.
KHz	Softkey selection of units.
SCALE	Hardkey in the DISPLAY FORMAT section. Wait until trace two has completed a full sweep before pressing the AUTOSCALE softkey.
AUTO SCALE	Softkey. AUTOSCALE will evaluate the values in all bins of the active trace to determine the new scale. When the SWEEP TYPE is ALTERNATE, these values are not updated until the next sweep of the trace. If a change is made that requires rescaling (and you choose to AUTOSCALE again), wait for the sweep to finish before pressing the AUTOSCALE softkey. The trace on the screen will be updated on the sweep following the AUTOSCALE command.
SWEEP TYPE	Hardkey in the SOURCE section.
SWP DIR UP DOWN	Softkey used to change the sweep direction for the active trace. This is a push-push toggle softkey. In this instance, selection of a different sweep direction is used only to demonstrate the use of the feature. See SWEEP DIRECTION listed under SWEEP TYPE in the REFERENCE section.

Now the measurement set up for the second trace is complete. Note that this extra set up is required only when alternate sweep is used. The following key presses will make the bandpass ripple measurement.

Making Measurements
Passband Ripple

Key	Description
MKR →	Hardkey in the DISPLAY FORMAT section.
MKR → MAX	Softkey used to move the marker to the point on the trace that has the largest value.
MKR	Hardkey in the DISPLAY FORMAT section.
ZERO MARKER	Softkey used to move the OFFSET MARKER (change the values of its position parameters) to the same position as the regular marker.
MKR →	Hardkey in the DISPLAY FORMAT section.
MKR → MIN	Softkey used to move the marker to the point on the trace that has the smallest value. The magnitude information in the MARKER Block for trace two is now indicating the measured passband ripple for this filter.

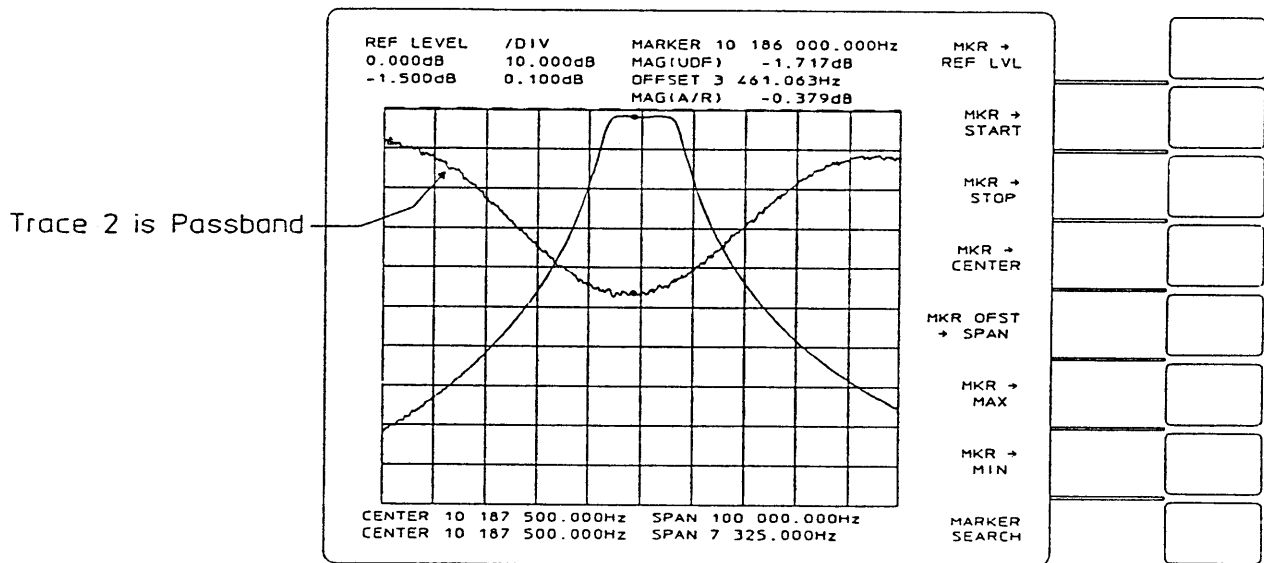

Figure 2-21. Passband Ripple

Passband Insertion Phase

The next measurement will be phase in the passband. To do this the sweep type will be returned to linear (the default type) so that the frequency span of trace two is the same as that of trace one.

KEY	DESCRIPTION
SWEEP TYPE	Hardkey in the SOURCE section.
LIN FREQ SWEEP	Softkey used to select linear frequency sweep.
INPUT	Hardkey in the DISPLAY FORMAT section.
COPY Trc 1 → 2	Softkey used to copy the INPUT definition for trace one into trace two. This normalizes trace two.
MKR	Hardkey in the DISPLAY FORMAT section
MKR OFST ON OFF	Softkey used to toggle the MARKER OFFSET OFF for the active trace (which should be trace two). The same can be done for trace one after the TRACE 1 hardkey is pressed.
DISPLY FCTN	Hardkey in the DISPLAY FORMAT section which displays a menu of softkeys used to select the DISPLAY FUNCTION of the active trace (indicated by the LED over the TRACE 2 key).
PHASE	Softkey used to select PHASE as the DISPLAY FUNCTION for the active trace. Selection of any softkey in this menu (other than off) turns trace two on.

Making Measurements
Passband Insertion Phase

Key Description

RPG KNOB

Moving the marker (with the knob) allows phase measurements to be made at any point on the trace. Data may be read from the marker block for trace two. The vertical parts of the trace represent 360° phase wraps. Since the HP 3577A stores data in complex form, $\pm 180^\circ$ is the range these values may have when interpreted as phase information. Note that trace two will be noisy in the same area as trace one, due to extremely low signal levels. See figure 2-22.

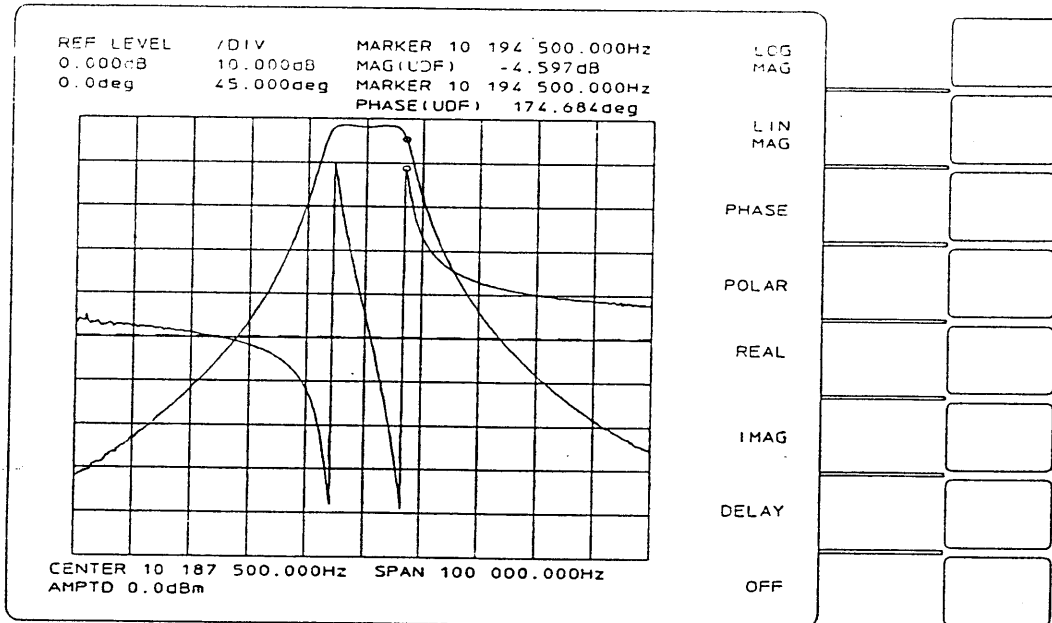

Figure 2-22. Bandpass Filter Magnitude & Phase Response

Group Delay

The next measurement is group delay. The DISPLAY FUNCTION menu should still be displayed.

Key	Description
DELAY	Softkey used to select group delay as the display function. Note that the softkey labeled DELAY changes to DELAY APERTURE.
SCALE	Hardkey in the DISPLAY FORMAT section.
AUTO SCALE	Softkey used to set the SCALE parameters such that the trace appears as large as possible without clipping the upper and lower boundaries of the graticule.
DISPLY FCTN	Hardkey used to recall the menu containing DELAY APERTURE.
DELAY APERTURE	Softkey used to display the menu of selections for group delay aperture (the change in frequency over which the change in phase is measured).
2 % OF SPAN	Softkey used to select a different delay aperture. DELAY APERTURE information (shown below the graticule) changes when different percent-of-span selections are made. The DELAY APER information will appear only when the trace whose display function is DELAY is selected. See figure 2-23.

Making Measurements
Group Delay

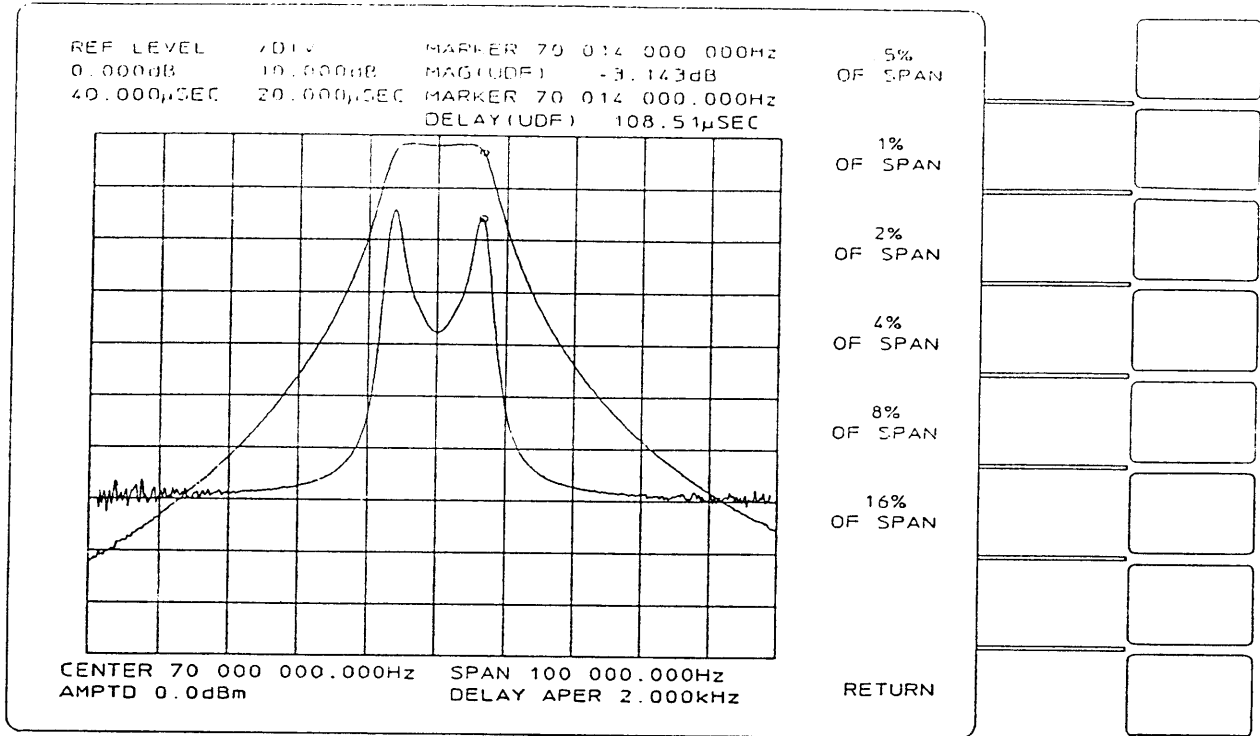

Figure 2-23. Bandpass Magnitude and Group Delay

$$\text{Group Delay } \tau_g = \frac{\Delta\Phi}{360 \times \Delta f} \text{ where } \Delta f = \frac{\text{Delay}}{\text{Aperture}}$$

Amplifier

Gain Compression

Connect the amplifier to the HP 3577A Network Analyzer as shown in figure 2-24. The receiver inputs will begin to overload when the input signal level is ≥ 0.0 dBm with receiver attenuation = 20 dB (overload also occurs at input signal levels ≥ -20 dBm with receiver attenuation = 0 dB). The amplifier used in this example has a gain of approximately 30 dB so 30 dB of attenuation was added to the circuit between the amplifier and the receiver input.

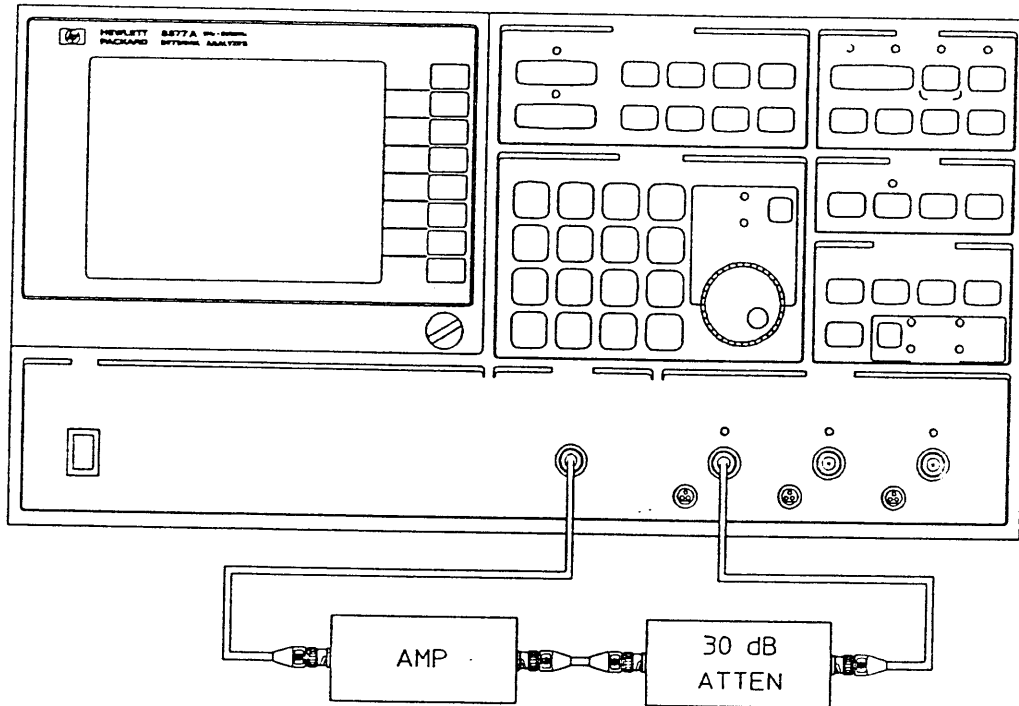

Figure 2-24.

Making Measurements
Amplifier

Key	Description
INSTR PRESET	Hardkey in the INSTRUMENT STATE section that resets parameters to their initial values.
SWEEP TYPE	Hardkey in the SOURCE section.
AMPTD SWEEP	Softkey that selects amplitude sweeps. Note the alphanumeric information under the graticule. The start amplitude is -40 dBm, the stop amplitude is 0.0 dBm, and the source frequency is 100 MHz.

Note



This feature will time out (change to SINGLE in the SWEEP MODE menu) after five minutes of continuous sweeping to extend the life of the switching relays in the output of the HP 3577A. Single sweeps may be triggered with the TRIG/RESET hardkey or CONTINUOUS sweep may be selected for another five minutes.

The plot shown in figure 2-25 is output level versus input level. Note that gain compression causes the trace to level out. To display gain compression (input versus gain) we will normalize. Normalization stores a measurement taken with a BNC barrel in place of the amplifier and then redefines the INPUT to be the old input definition divided by the stored trace. This makes the trace gain versus input.

MEASR CAL	Hardkey in the DISPLAY FORMAT section.
USER ACTION	Replace the amplifier with a BNC barrel, and wait for a full sweep.
NORMLIZE	Softkey used to normalize the measurement.
USER ACTION	Replace the BNC barrel with the amplifier.
SCALE	Hardkey in the DISPLAY FORMAT section.
USER ACTION	Wait for Sweep to complete
AUTO SCALE	Softkey described previously.

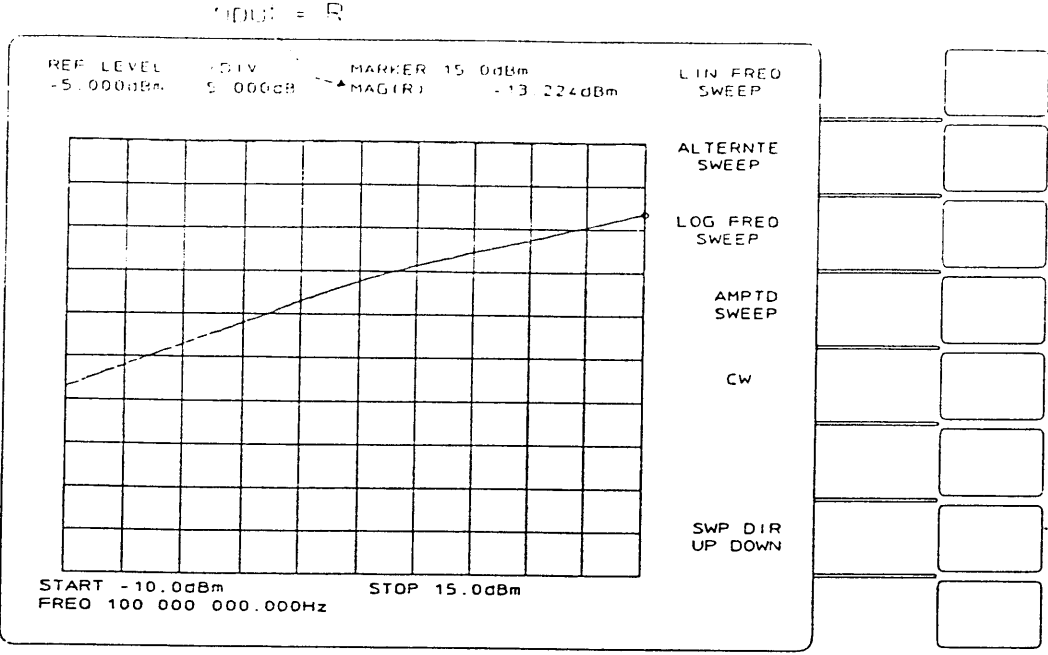

Figure 2-25. Amplitude Sweep of an Amplifier

Making Measurements
Amplifier

Now the trace is amplifier input vs gain. The gain is constant where the trace is level and is in compression where the trace rolls off. Next we'll use the marker to search for the 3 dB compression point.

Key	Description
MKR →	Hardkey in the DISPLAY FORMAT section.
MKR → MAX	Softkey used to move the marker to the point on the trace with the largest gain value.
MKR	Hardkey in the DISPLAY FORMAT section.
ZERO MARKER	Softkey used to turn the offset marker on at the position of the regular marker.
MKR →	Hardkey in the DISPLAY FORMAT section.
MARKER SEARCH	Softkey used to display the MARKER SEARCH menu. Note that the marker target value is -3 dB.
MKR → R TARG	Softkey used to search right for target. The marker information block now contains the span over which the amplifier has a gain compression of -3 dB. See figure 2-26.
MKR	Hardkey in the DISPLAY FORMAT section.
MKR OFST ON OFF	Softkey used to turn the offset marker off. The marker information block will change from OFFSET to MARKER information. The MARKER magnitude is the input level at which the amplifier has a gain compression of 3 dB. See figure 2-27.

Compression Range
UDF = R/D1

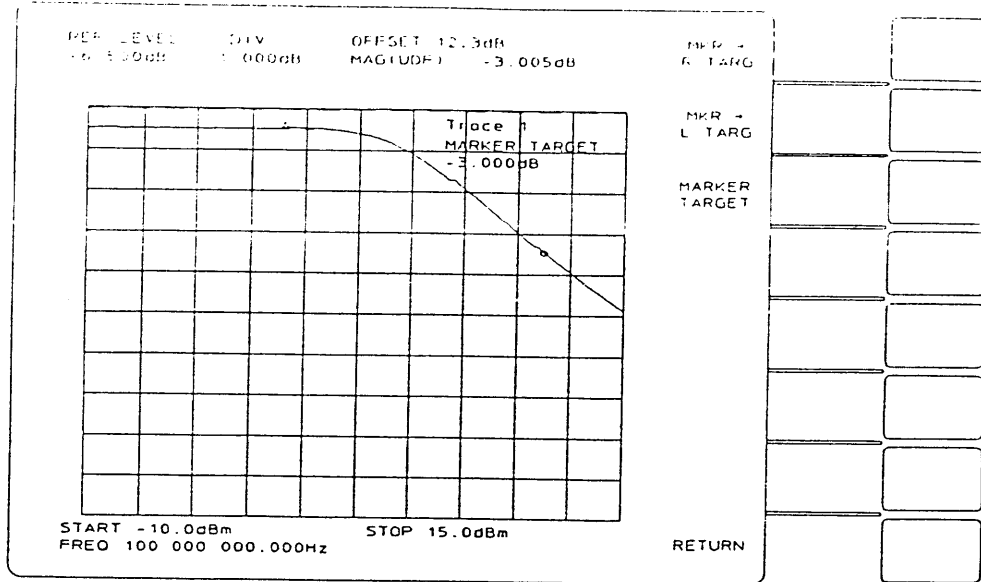

Figure 2-26. Gain Compression of an Amplifier

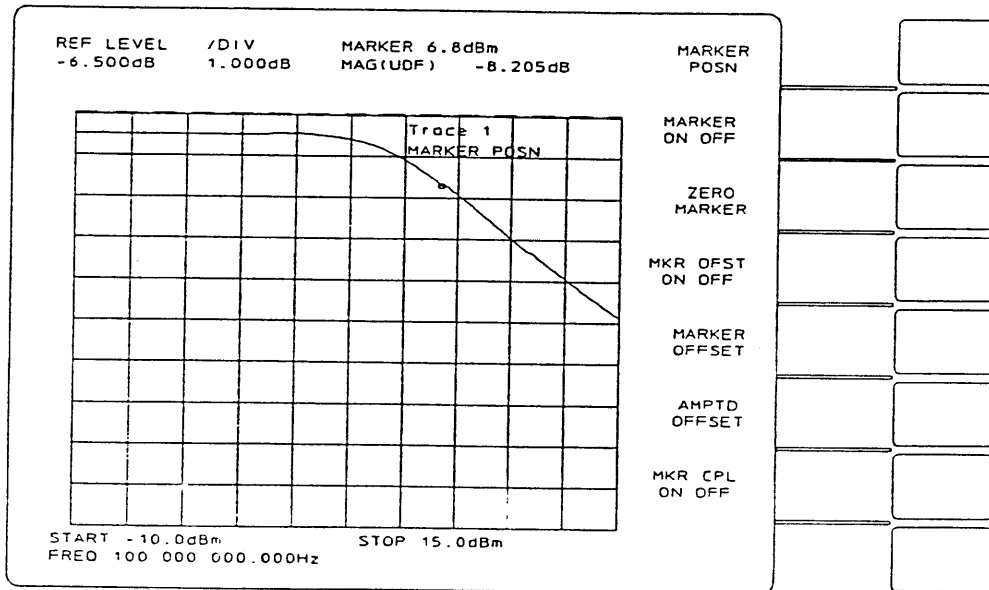

Figure 2-27. 3 dB Compression Level

This test may be run again at other frequencies for more thorough testing of the amplifier.

Low Pass Filter

Connect the HP 35677A/B S-Parameter Test Set to the HP 3577A Network Analyzer and connect the low pass filter to be tested to the HP 35677A/B as shown in figure 2-28. The low pass filter used in this example has a -3 dB frequency of 50 MHz, but the methods used to measure its characteristics are the same for any low pass filter.

The HP 35677A/B is a convenient accessory for making ratio measurements of transmission and reflection scattering parameters. The test set has two configurations: FORWARD and REVERSE, indicated by two LEDs on the upper left corner of the front panel. This configuration is controlled through the HP 3577A Network Analyzer by defining the INPUT. Figure 2-29 shows the test set block diagram for each configuration.

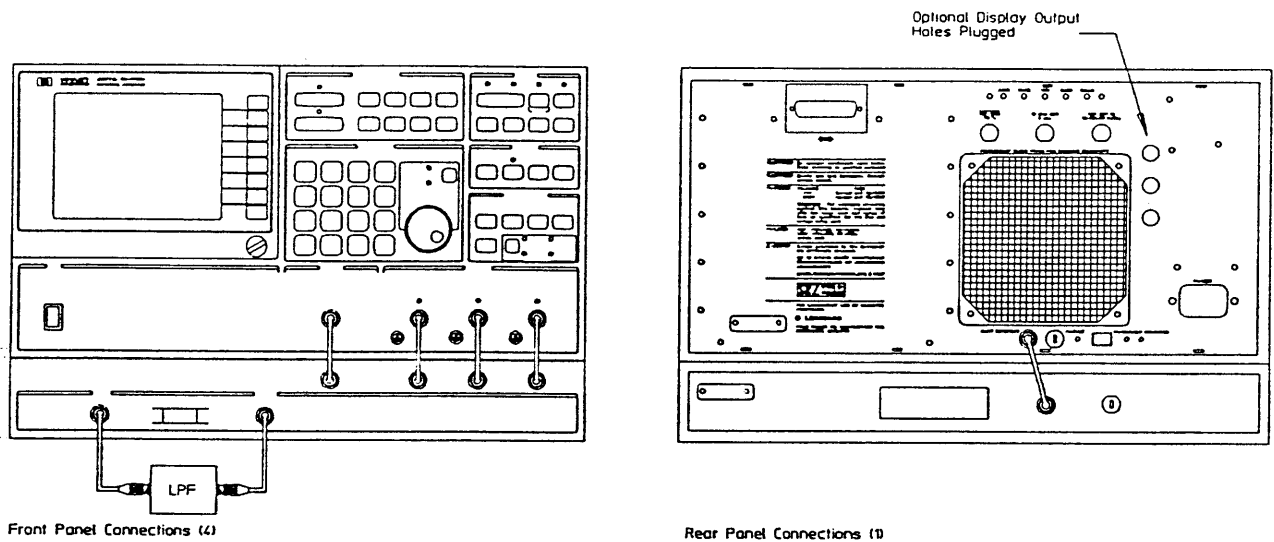

Figure 2-28. HP 3577A to HP 35677A/B Connections

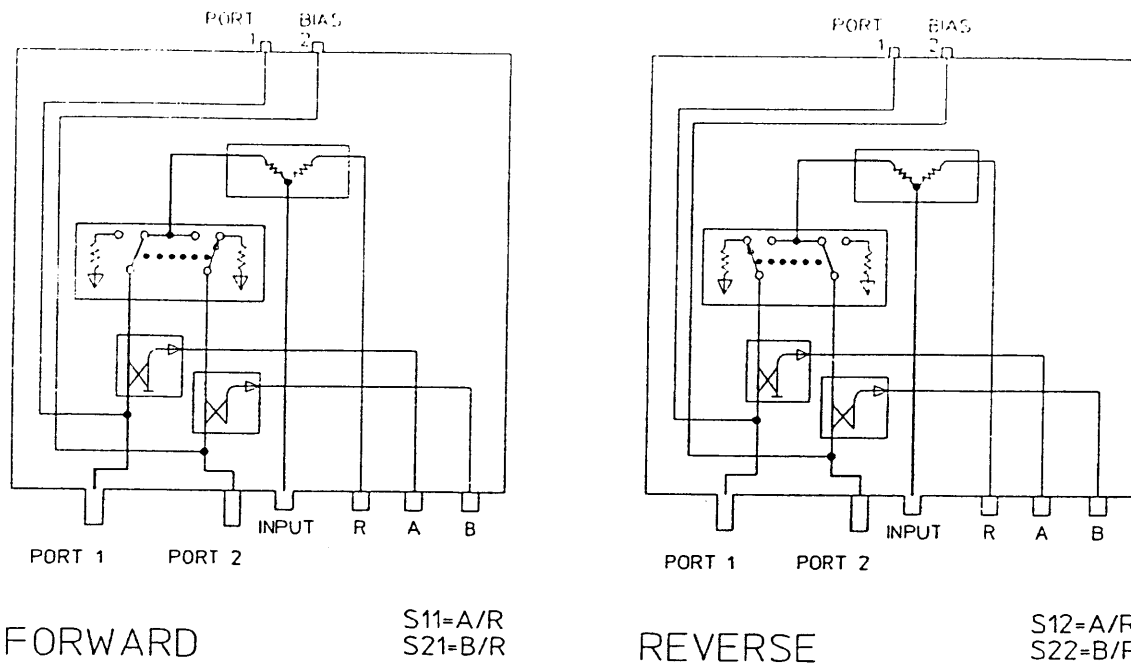

Figure 2-29. HP 35677A\B Configurations

The purpose of this measurement exercise is to demonstrate the use of the HP 35677A/B S-Parameter Test Set and the HP 3577A Network Analyzer to characterize a low pass filter. The general organization is:

1. Set up the measurement
2. Measure the insertion loss
3. Measure the insertion phase
4. Measure the passband ripple
5. Measure the stop band rejection

Measurement Set-up

Key	Description
INSTR PRESET	Hardkey in the INSTRUMENT STATE that presets the HP 3577A parameters to their default values. When the HP 35677A/B S-Parameter Test Set is connected to the HP 3577A via the rear panel cable, INSTR PRESET parameters differ as follows:

START FREQ	100 kHz
SOURCE AMPLITUDE	+15 dBm
INPUT (both traces)	S ₂₁ (same as B/R)
LENGTH B	1.3 meters

INSTRUMENT PRESET always displays the **INPUT** menu. Note that S₂₁ is bright in the menu. This indicates that it is the active INPUT definition of the selected trace. Also note the entry block showing that the input is B/R. This indicates that S₂₁ is the same as B/R with the test set in the FORWARD configuration. See figure 2-30.

SWEEP TYPE Hardkey in the SOURCE section

LOG FREQ SWEEP Softkey that selects a logarithmic frequency sweep. Note that the screen includes frequency annotation shown across the bottom of the graticule. See figure 2-31.

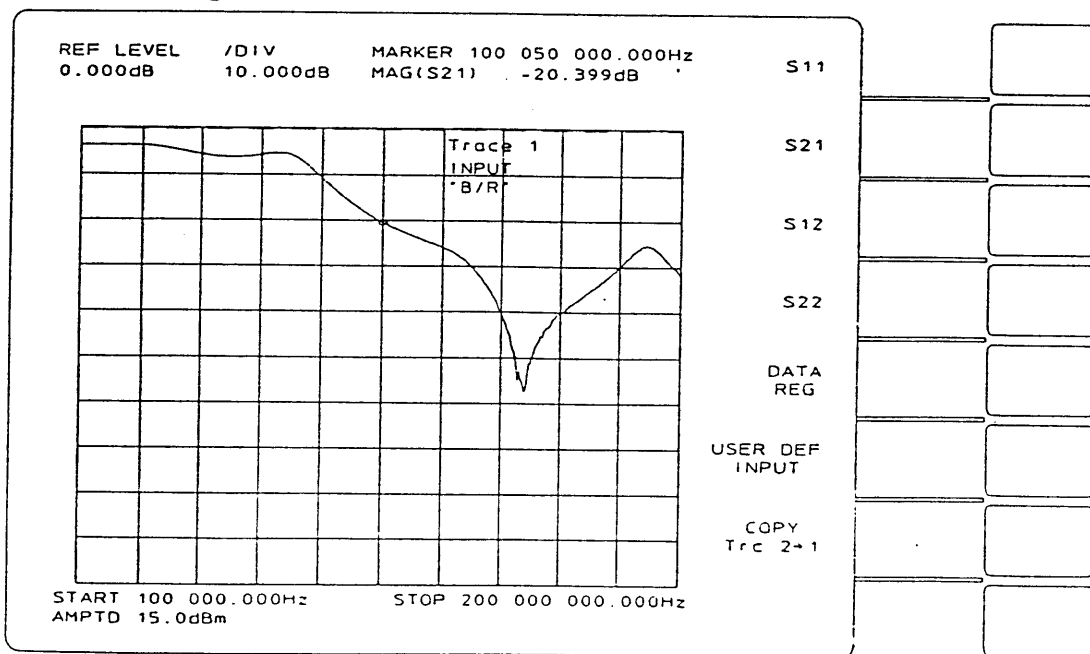

Figure 2-30. S-Parameter Input Menu

Note



If you need to change the **FREQ** or **AMPTD** parameters to get the correct measurement set up, do so at this point. Only two data entry parameters exist in the **FREQUENCY** menu when the **SWEEP TYPE** is **LOG FREQ**: **START** and **STOP FREQ**. (**FULL SWEEP** is an immediate execution command; not data entry).

MEASR CAL

Hardkey in the **DISPLAY FORMAT** section used to display the **MEASUREMENT CALIBRATION** menu, which includes the softkey, **NORMLIZE**.

USER ACTION

Replace the device under test with a BNC "barrel" (BNC(f) to BNC(f) adapter). Be sure to wait until the next sweep is complete before executing the next step.

NORMLIZE

Softkey used to normalize the measurement. The HP 3577A does this by storing the trace with the barrel and redefining the **INPUT** to be the previous definition divided by the stored trace (in this case **B/R/D1**).

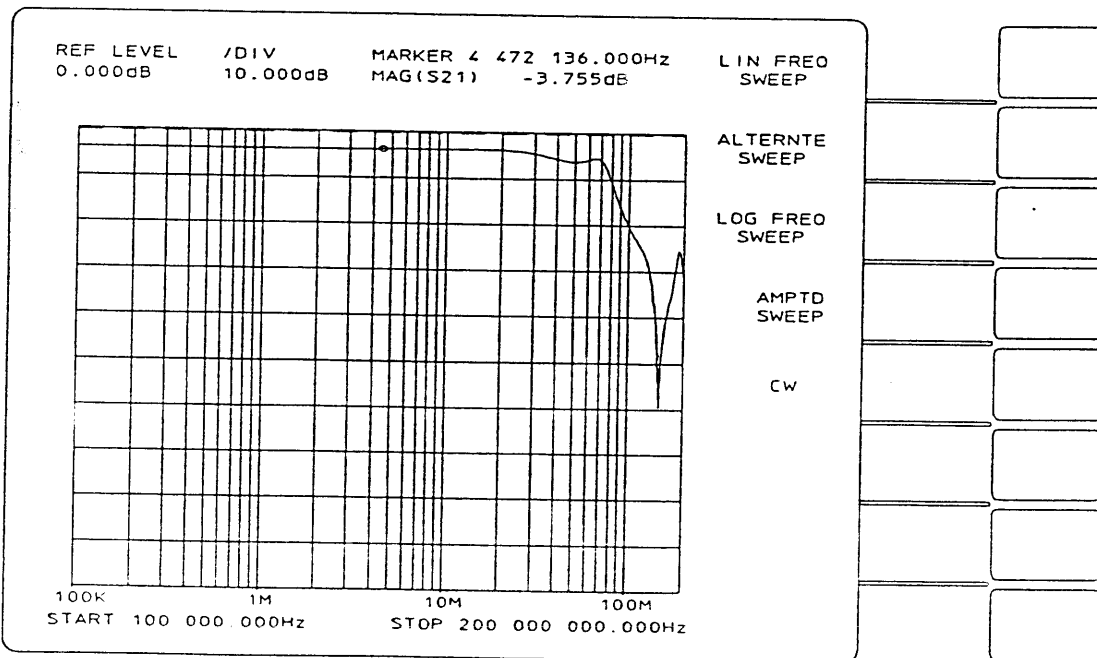

Figure 2-31. Log Frequency Sweep Type

Insertion Loss

Key	Description
-----	-------------

USER ACTION Replace the BNC barrel with the filter to be tested.

RPG KNOB The marker may be moved to any part of the trace with the knob (must be in MARKER mode) to measure insertion loss. See figure 2-32.

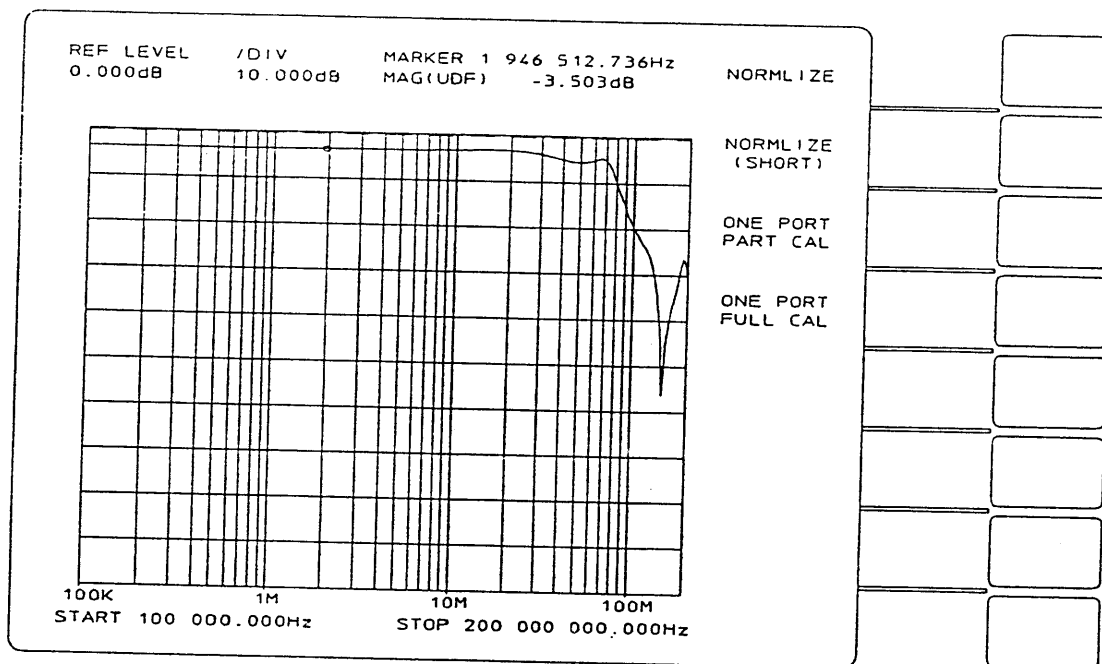
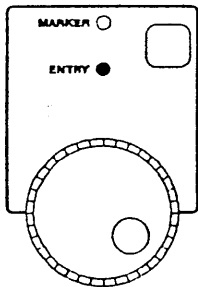

Figure 2-32. Measurement Calibration Menu

Insertion Phase

Key	Description
DISPLY FCTN	Hardkey in the DISPLAY FORMAT section
TRACE 2	Hardkey in the DISPLAY FORMAT section that redefines the menu displayed to operate on trace two. Note that the trace is off.
PHASE	Softkey used to turn on trace two and define it to be phase information. Note that the trace appears immediately. No new data need be collected (no sweep is required) for trace two to be displayed as PHASE. Note the vertical parts of the phase trace. This jump of 360°, from -180° to +180°, is called a phase wrap.
SCALE	Hardkey in the DISPLAY FORMAT section. Note that REF LEVEL is bright in the menu. Reference level is the measured signal level represented by the dashed line. For PHASE, this line will appear at midscreen. (It may be moved up or down by changing the value of REF POSN). Next, the knob will be used to redefine the value of REF LEVEL.



Press the unlabeled key above the knob. This key press should put the knob in ENTRY mode, so that it may be used to modify the value of the active data entry softkey in the menu.

Turn the knob counterclockwise. The trace moves toward the top of the graticule and the value of REF LEVEL in the ENTRY BLOCK and above the upper left corner of the graticule changes.

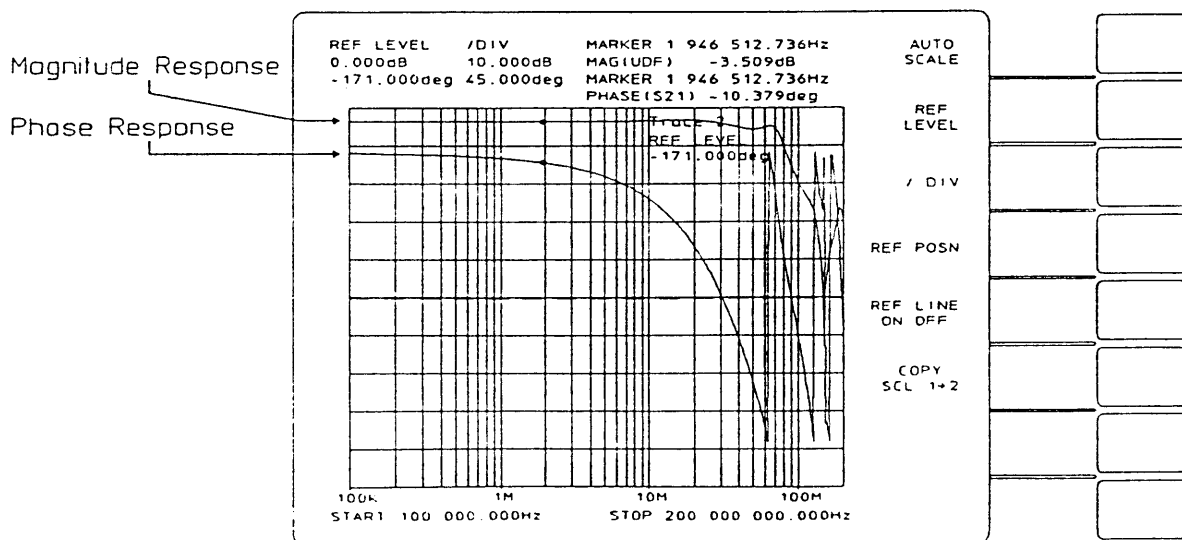

Figure 2-33. Low Pass Filter Log Magnitude and Phase Response

Passband Ripple

Key	Description
DISPLY FCTN	Hardkey in the DISPLAY FORMAT section.
OFF	Softkey in the DSPLY FCTN menu used to turn the active trace (which should still be trace two) off.
TRACE 1	Hardkey in the DISPLAY FORMAT section.
MKR →	Hardkey in the DISPLAY FORMAT section.
MARKER SEARCH	Softkey that displays a second menu used to make marker searches. Note that MARKER TARGET is active and that its default value shown in the ENTRY BLOCK is - 3 dB.
MKR → R TARG	Softkey used to search right for the MARKER TARGET value. Note the new value of magnitude for the marker. If no such value had been found the marker would not have moved and the screen message "TARGET VALUE NOT FOUND" would appear.
RETURN	Softkey used to move back to the primary menu. Note that the MKR → hardkey could have been used to display the same menu.
MKR → STOP	Softkey used to redefine the STOP FREQ as the present marker position (frequency). Note that the graticule is redrawn and that the frequency annotation changes to match the new sweep. Note: this change in frequency requires renormalization or changing the INPUT definition back to B/R.
INPUT	Hardkey described previously.
S21	Softkey used to define S-parameter. This step changes the INPUT definition from B/R/D1 to B/R. Since the frequency span has been changed, D1 should not be used in the definition until the measurement is re-normalized.
SCALE	Hardkey in the DISPLAY FORMAT section.

AUTO SCALE Softkey. The trace displayed is of the passband. Note the change in the /DIV value in the upper left-hand corner of the screen. See figure 2-34.

ENTRY OFF Hardkey in the DATA ENTRY section that clears the screen of the ENTRY BLOCK and the menu. This key may be used to disable data entry so that unintentional rotation of the knob (in ENTRY mode) does not modify a parameter.

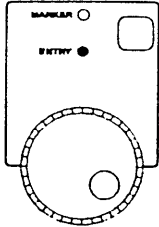

The marker may be used to measure the passband ripple. The knob must be in MARKER mode for it to be used to move the marker (see the LEDs above the knob). Note that the “up” and “down” arrow keys may also be used to move the marker (if you press MKR hardkey and MARKER POSN softkey).

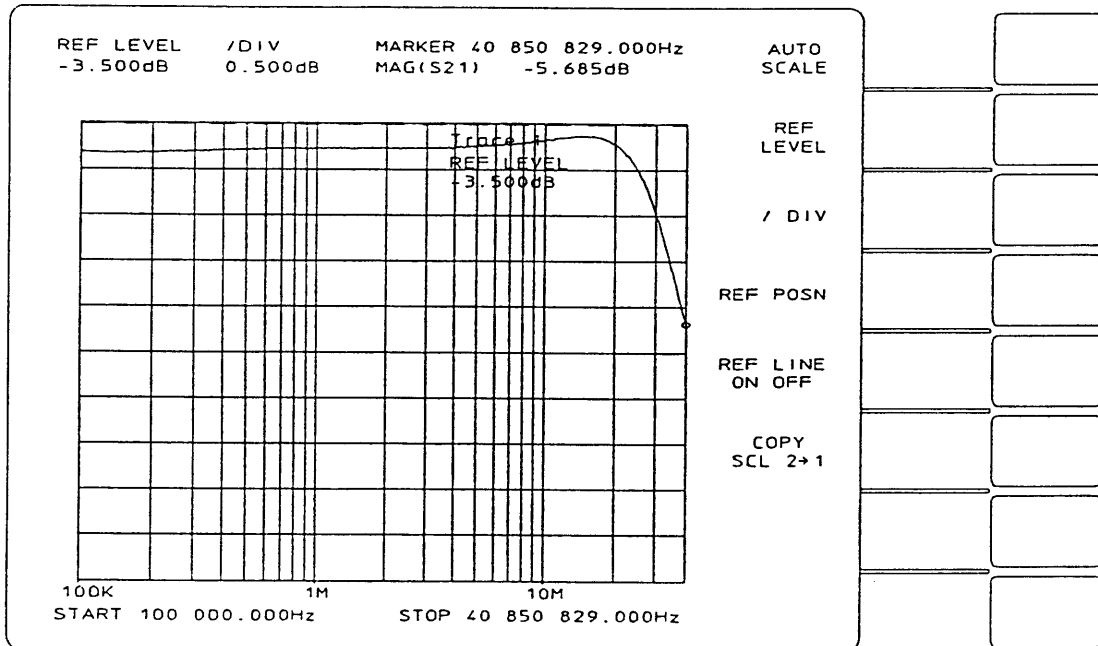

Figure 2-34. Low Pass Filter Pass Band Ripple

Stopband Rejection

Key	Description
FREQ	Hardkey in the SOURCE section.
STOP FREQ	Softkey used to select stop frequency as the parameter for data entry.
2 0 0	Data entry.
MHz	Softkey used to select units for data entry.
MKR →	Hardkey in the DISPLAY FORMAT section.
MARKER SEARCH	Softkey. Note that the target value is -3 dB.
MKR → L TARG	Softkey used to move the marker left to the -3 dB point. This point will be used as the start frequency for sweeping the stopband.
RETURN	Softkey used to return to the primary menu.

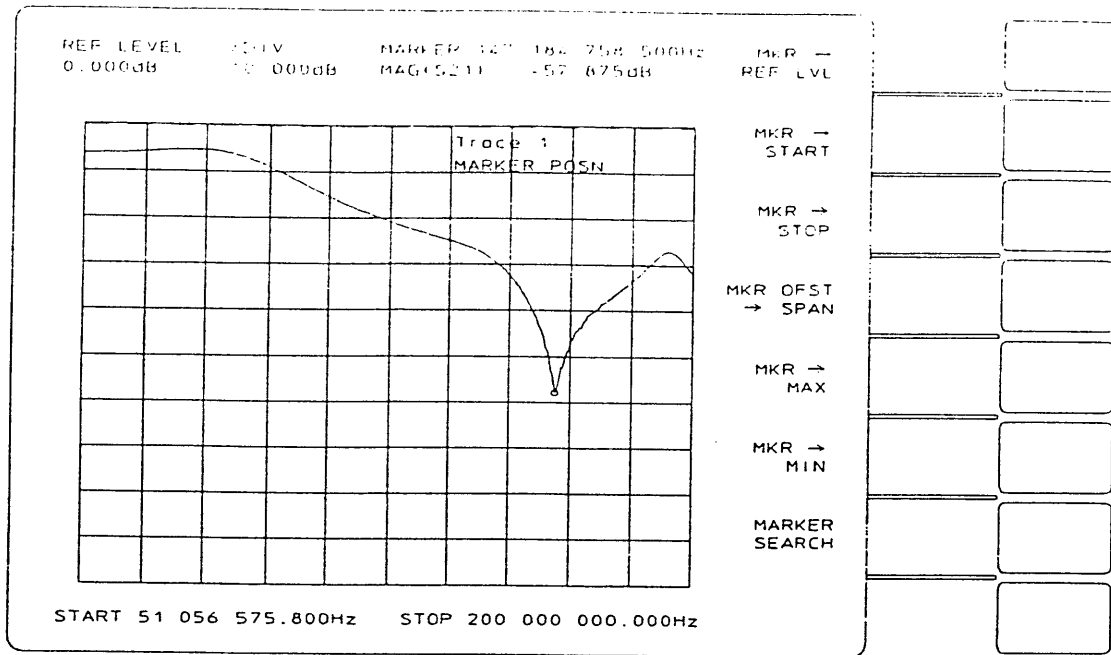

Figure 2-35. Low Pass Filter Stop Band Rejection

Amplifier S-Parameters

Connect the amplifier to the HP 35677A/B as shown in figure 2-36. Fifteen volt power to the amplifier is supplied by an external power supply. The amplifier used in this example has a gain rating of +15 dB from 0.5 MHz to 100 MHz. The methods used here may be used to test amplifiers with different specifications.

The purpose of this measurement exercise is to demonstrate the use of the HP 3577A Network Analyzer and the HP 35677A/B S-Parameter Test Set to characterize the scattering parameters of an RF amplifier. The organization of the exercise is:

1. Initial measurement set up
2. Measure S_{21}' forward gain and phase
3. Measure S_{12}' reverse loss
4. Measure S_{11}' input return loss
5. Measure S_{22}' output reflection coefficient
6. Conversion of reflection coef. to complex impedance

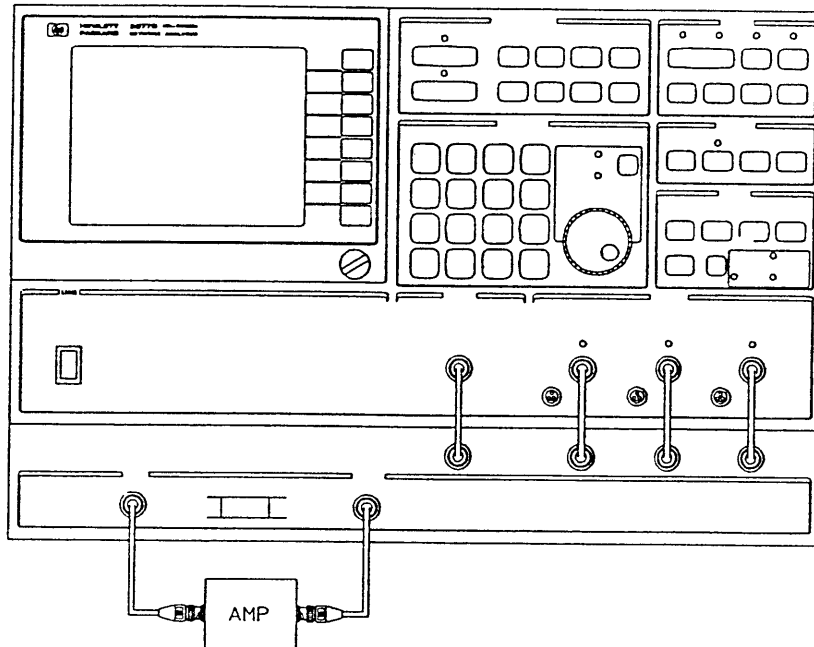

Figure 2-36

Measurement Setup

Key	Description
INSTR PRESET	Hardkey in the INSTRUMENT STATE section used to reset all parameters to their default values. The menu displayed on the screen is the INPUT menu. Note that the default INPUT definition is S_{21} (B/R & test set FORWARD) when the HP 35677A/B S-Parameter Test Set is connected to the HP 3577A Network Analyzer.

Note



If the amplifier was on when **INSTR PRESET** was pressed, one or more of the receiver inputs may have tripped or been overloaded. A receiver “trip” is when the receiver input switches to $1M\Omega$ to protect itself from high input signal levels. This switch occurs for signals $\geq 1.1 V_{pk}$.

The screen message:

INPUT X TRPPEP (X=R,A, or B)

Clear trip on **ATTEN** menu.

appears, listing the input(s) tripped and directing the user to the **ATTEN** hardkey to clear the condition. Note that the impedance softkeys in the **ATTEN** menu will not reflect the tripped condition. Clear the trip with the **CLEAR TRIP** softkey after the value of **AMPTD** is changed.

FREQ	Hardkey in the SOURCE section. Note that START FREQ is selected (ready for data entry).
5 0	Data entry.
MHz	Softkey selection of units for the data entry.
AMPTD	Hardkey in the SOURCE section.
0	Data entry.
dBm	Softkey selection of units for the data entry.
ATTEN	Hardkey in the RECEIVER section.
CLEAR TRIP	Softkey used to reset a tripped receiver input.

If no inputs were tripped, display message = NO INPUTS ARE TRIPPED.

Key	Description
MEASR CAL	Hardkey in the DISPLAY FORMAT section used to display the MEASUREMENT CALIBRATION menu.
USER ACTION	Replace the amplifier with a BNC barrel and wait for one complete sweep.
NORMLIZE	Softkey used to normalize the measurement. This stores a trace in data register D1 and redefines the INPUT to be the old definition divided by the stored trace. If trace two had been active, the store would have been to D2. If you press the INPUT hardkey you can see in the entry block that the INPUT definition is B/R/D1. Also note that the marker block has changed from MAG(S₂₁) to MAG(UDF) ; UDF is the abbreviation for "user defined function."
USER ACTION	Replace the BNC barrel with the amplifier.
SCALE	Hardkey in the DISPLAY FORMAT section so change in reference position, reference level, and scale resolution (/DIV) can be made.
REF POSN	Softkey used to select REFERENCE POSITION for data entry.
8 0	Data entry with the numeric key pad.
%	Softkey selection of units. Note that the dashed line moved from the top of the graticule down to the eighth division from the bottom.
REF LEVEL	Softkey used to select REFERENCE LEVEL for data entry.
1 5	Data entry.
dB	Softkey selection of units for the data entry.
/DIV	Softkey used to prefix a data entry for the graticule scale.
5	Data entry.
dB	Softkey selection of units for the data entry.

Key **Description**

Now trace one is completely set up. Next, trace two will be turned and setup for phase information and set it up.

- DISPLY FCTN** Hardkey in the DISPLAY FORMAT section.
- TRACE 2** Hardkey in the DISPLAY FORMAT section.
- PHASE** Softkey used to turn trace two on and make it phase information.
- INPUT** Hardkey in the DISPLAY FORMAT section.
- COPY**
Trc 1 → 2 Softkey used to copy the INPUT definition for trace one into trace two. Note that the ENTRY BLOCK shows trace two INPUT to be B/R/D1. This equation was created when trace one was normalized. This copying of INPUT definition normalizes trace two.
- SCALE** Hardkey in the DISPLAY FORMAT section.
- AUTO SCALE** Softkey previously described. See figure 2-37.

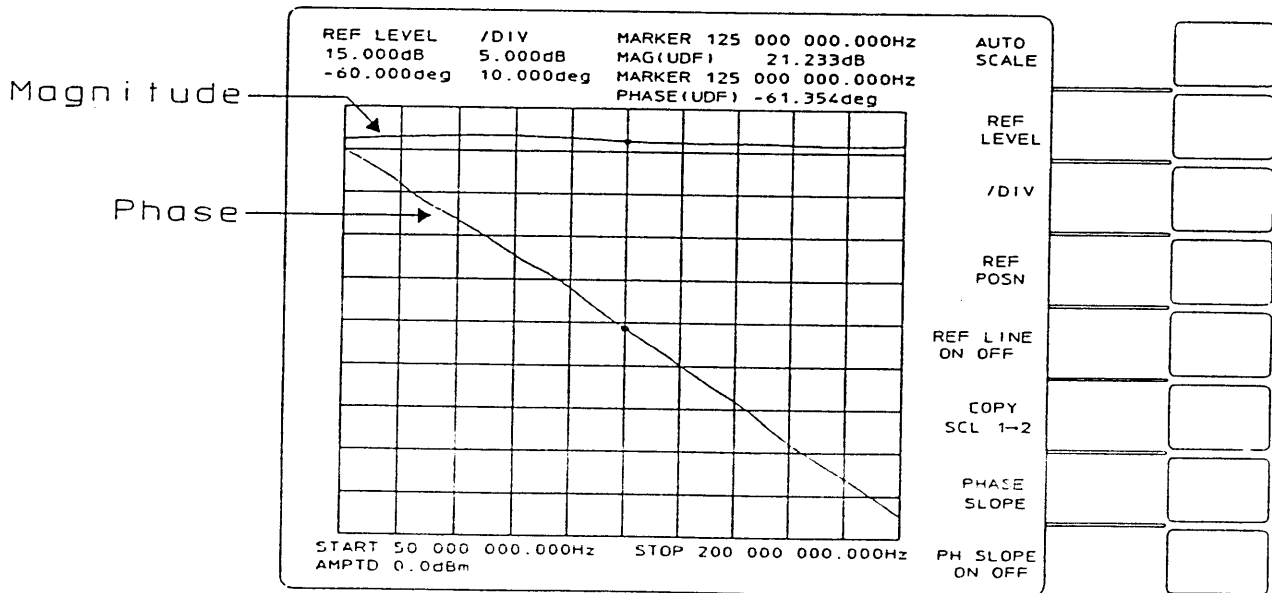

Figure 2-37. RF Amplifier Magnitude and Phase of S21

S21' Forward Gain and Phase

The display as shown in figure 2-37 is the forward gain and phase of the amplifier under test. The markers may be used to make exact measurements at points along the traces and to make offset measurements.

Key	Description
MKR	Hardkey in the DISPLAY FORMAT section.
MKR CPL ON OFF	Softkey that toggles marker coupling between the ON and OFF conditions. This key press should leave OFF bright.
RPG KNOB	Turning the knob with marker coupling off will move only the marker on the active trace.
TRACE 1	Hardkey in the DISPLAY FORMAT section.
MKR →	Hardkey in the DISPLAY FORMAT section.
MKR → MIN	Softkey used to move the marker to the point on the active trace with the lowest value.
MKR	Hardkey in the DISPLAY FORMAT section.
ZERO MARKER	Softkey used to initialize the offset marker at the position of the regular marker. Note that the information in the marker block for trace one has changed from MARKER to OFFSET.
MKR →	Hardkey in the DISPLAY FORMAT section.
MKR → MAX	Softkey used to move the marker to the point on the active trace with the largest value. The information in the marker block is now total amplifier ripple. See figure 2-38.

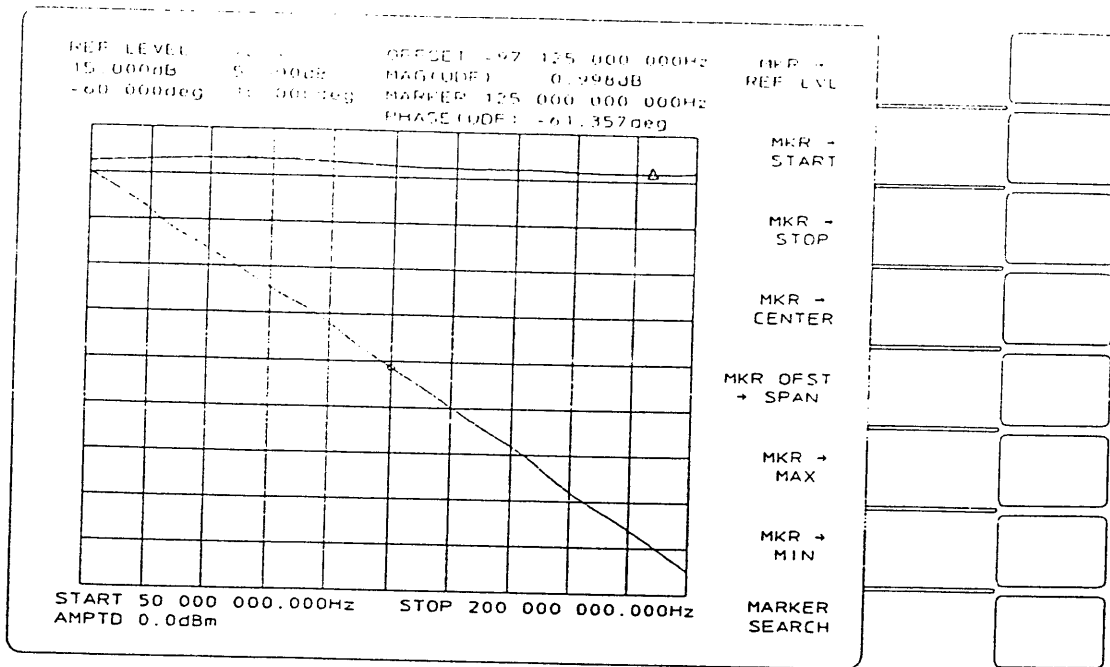

Figure 2-38. Measuring Amplifier Ripple

S₁₂ Reverse Loss

Key	Description
INPUT	Hardkey in the DISPLAY FORMAT section.
S12	Softkey selection of a new INPUT definition. This causes the test set to change to the REVERSE configuration. See figure 2-39.

The screen message:

INCOMP. TESTSET POSITIONS
 Trc2 chgd to agree with #1

will appear. This message (incompatible test set positions; trace two changed to agree with number one) is caused by the change of INPUT for trace one. The old trace two INPUT definition had the test set configured FORWARD. Since the test set can't be configured both ways at the same time, the HP 3577A has changed the HP 35677A/B configuration to REVERSE and displayed a screen message to let the user know that the trace two INPUT definition has changed.

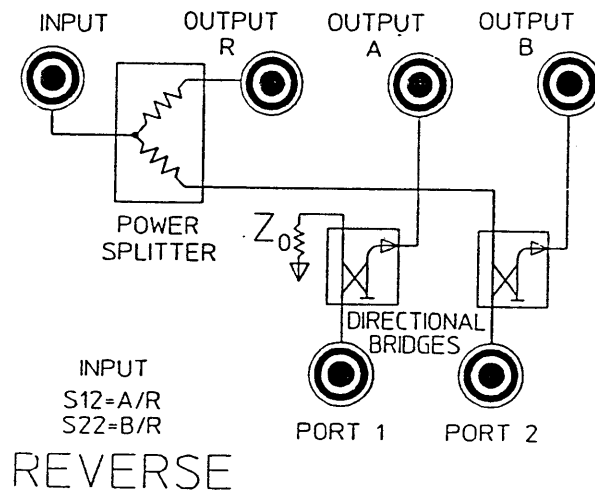

Figure 2-39. S-Parameter Test Set Reverse Configuration

Key	Description
MKR	Hardkey in the DISPLAY FORMAT section.
MKR OFST ON OFF	Softkey used here to turn off the offset marker.
MEASR CAL	Hardkey in the DISPLAY FORMAT section.
USER ACTION	Replace the amplifier with a BNC barrel. Wait for complete sweep.
NORMLIZE	Softkey used to normalize the measurement as described previously.
USER ACTION	Replace the BNC barrel with the amplifier.
SCALE	Hardkey in the DISPLAY FORMAT section.
USER ACTION	Wait for complete sweep.
AUTO SCALE	Softkey described previously.
TRACE 2	Hardkey used to select trace two as the active trace.
INPUT	Hardkey in the DISPLAY FORMAT section. Note that the current INPUT definition (listed in the entry block) is B/R/D1.
COPY Trc 1 → 2	Softkey used to copy the INPUT definition for trace one into trace two. Note that the INPUT definition in the entry block has changed to A/R/D1. This normalizes trace two.
SCALE	Hardkey in the DISPLAY FORMAT section.
AUTO SCALE	Softkey described previously.

Key

Description

MKR

Hardkey in the DISPLAY FORMAT section.

**MKR CPL
 ON OFF**

Softkey used here to turn marker coupling back on. Note that both markers are now at the same frequency and will move together when the knob is turned.

TRACE 1

Hardkey in the DISPLAY FORMAT used to select trace one as the active trace, making it and its alphanumeric information above the screen bright.

The markers may be used to measure reverse loss and reverse phase angle. See figure 2-40.

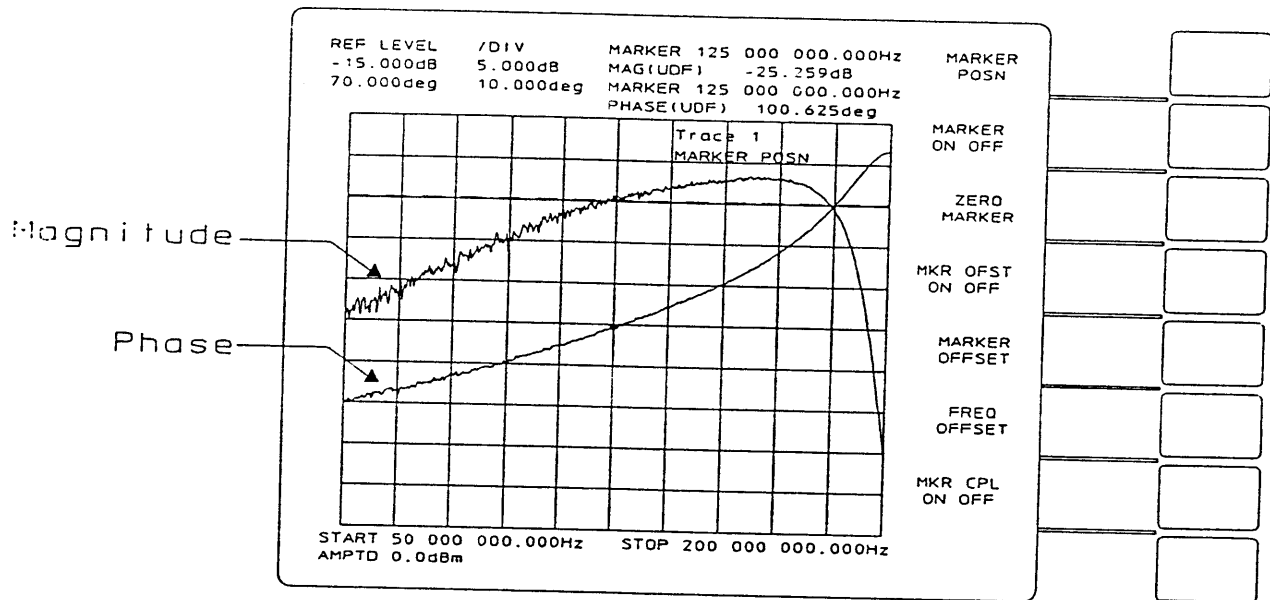

Figure 2-40. Normalized Reverse Loss and Phase

S₁₁ Input Return Loss

Next, input reflection will be examined. This is possible through the use of the directional bridges of the HP 35677A/B S-Parameter Test Set. In this example, full one-port calibration using three term error correction is employed for maximum measurement accuracy.

Key	Description
INPUT	Hardkey in the DISPLAY FORMAT section.
S11	Softkey selection of S-parameter S ₁₁ as the INPUT.
MEASR CAL	Hardkey in the DISPLAY FORMAT section.
ONE PORT FULL CAL	Softkey. Note the screen message LEAVE PORT 1 OPEN. See figure 2-41.
USER ACTION	Disconnect the device under test from its input cable (port 1).

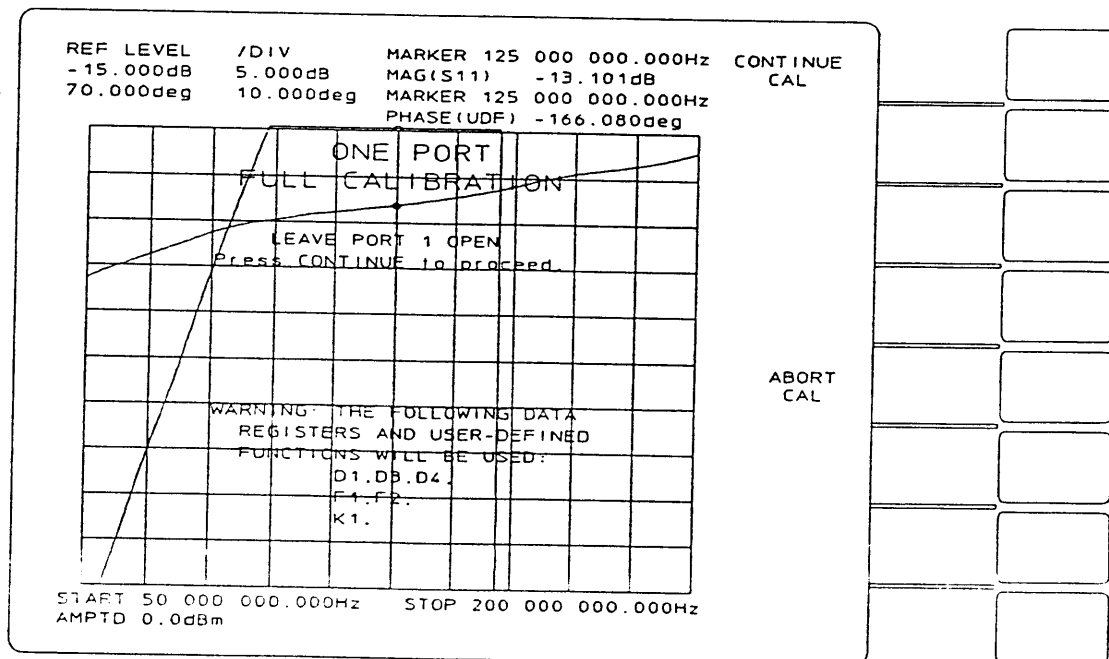

Figure 2-41. Screen Messages for One-Port Full Calibration

Key	Description
CONTINUE CAL	Softkey. After a sweep, note the screen message INSTALL SHORT ON PORT 1.
USER ACTION	Install a shorted termination on the input cable where the device under test was connected.
CONTINUE CAL	Softkey. After a complete sweep and some calculation time, note the screen message INSTALL REFERENCE LOAD ON PORT 1.
USER ACTION	Replace the short termination with a reference load. (50Ω for HP 35677A or 75Ω for HP 35677B).
CONTINUE CAL	Softkey. After a complete sweep and some more calculation time, note the screen message

CALIBRATION COMPLETE
INPUT= "F2" : CALIBRATED REFLECTION

This message to the user says that the INPUT definition has been changed to the user defined function F2. See MEASUREMENT CALIBRATION in the REFERENCE section for more details.

USER ACTION	Connect the cable back to the input of the device.
SCALE	Hardkey in the DISPLAY FORMAT section.
USER ACTION	Wait for complete sweep.
AUTO SCALE	Softkey described previously.
TRACE 2	Hardkey in the DISPLAY FORMAT section. Note that the SCALE menu is still displayed and selections made from it will affect trace two.
INPUT	Hardkey described previously.
COPY Trc 1 → 2	Softkey described previously.
SCALE	Hardkey described previously.
AUTO SCALE	Softkey described previously.

Key	Description
TRACE 1	Hardkey in the DISPLAY FORMAT section.
MKR →	Hardkey in the DISPLAY FORMAT section.
MKR → MIN	Softkey used to search for the minimum magnitude (in this case, maximum RETURN LOSS or best impedance match).

The display is now input return loss magnitude (trace one) and phase (trace two). Measurements may be made with the markers by turning the knob to move them along the trace. Marker data appears in the marker information block above the graticule. See figure 2-42.

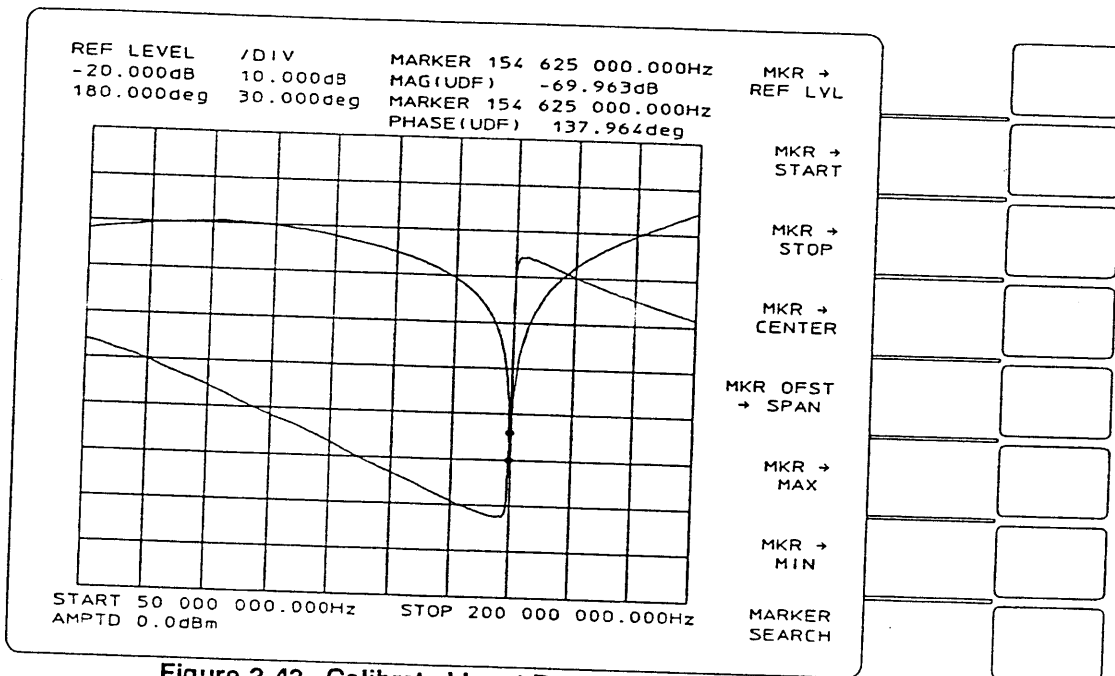

Figure 2-42. Calibrated Input Return Loss and Phase Response

S₂₂ Output Reflection Coefficient

Next, the setup to measure S₂₂' will be made the output reflection coefficient, using the HP 35677A/B in the REVERSE configuration.

Key	Description
INPUT	Hardkey in the DISPLAY FORMAT section.
S22	Softkey used to select B/R as the INPUT with the test set in the REVERSE configuration.
MEASR CAL	Hardkey in the DISPLAY FORMAT section.
USER ACTION	Disconnect the cable from the amplifier output and leave the end of the cable open.
NORMLIZE	Softkey used to normalize the measurement as described previously. This feature may be used with an "open" termination for reflection measurements as well as with a BNC barrel for transmission measurements.
USER ACTION	Reconnect the output of the amplifier to the PORT 2 cable.
DISPLY FCTN	Hardkey in the DISPLAY FORMAT section.
POLAR	Softkey used to display trace information in a polar format. Note that only one trace may be on when using the POLAR display function. Trace two is turned off when POLAR is selected for trace one. See figure 2-43.

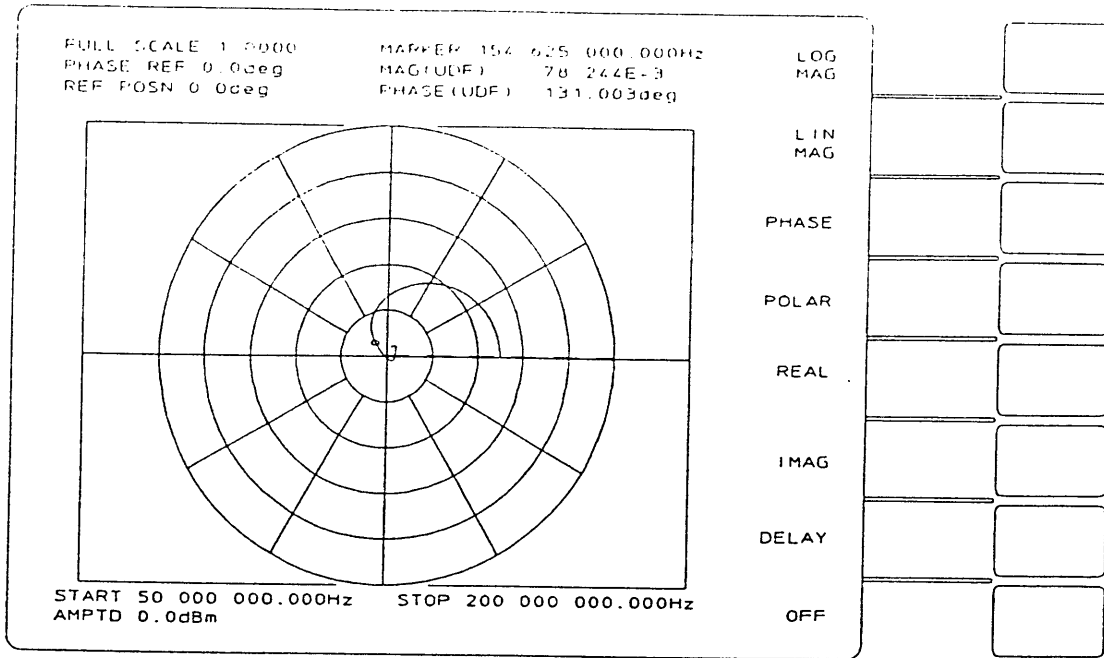

Figure 2-43. Polar Display Function of Normalized RF Amplifier Output Reflection

Now the display shows the trace of the reflection coefficient of the amplifier output from 50 MHz to 200 MHz. Note that the marker magnitude units are in linear units. The marker may be moved as described previously to make measurements on the trace.

Complex Output Impedance

Next, the Smith chart graticule will be used to convert reflection coefficient to complex impedance and change the marker units from magnitude and phase to real and imaginary.

Key	Description
SCALE	Hardkey in the DISPLAY FORMAT section.
SMITH CH ON OFF	Softkey which appears in the SCALE menu when the display function is POLAR. This softkey toggles the Smith chart on and off. Note that the marker units change from MAG and PHASE to Z MAG and Z PHASE, or impedance magnitude and phase. This may be changed to read directly in real and imaginary units as shown next.
MKR	Hardkey in the DISPLAY FORMAT section.
MARKER M,P R,I	Softkey that appears in the marker menu when the display function is POLAR. This softkey toggles the marker units between Magnitude & Phase and Real & Imaginary units. Note the correspondence between the Smith chart graticule and the marker units. See figure 2-44.

Marker readout in
complex impedance

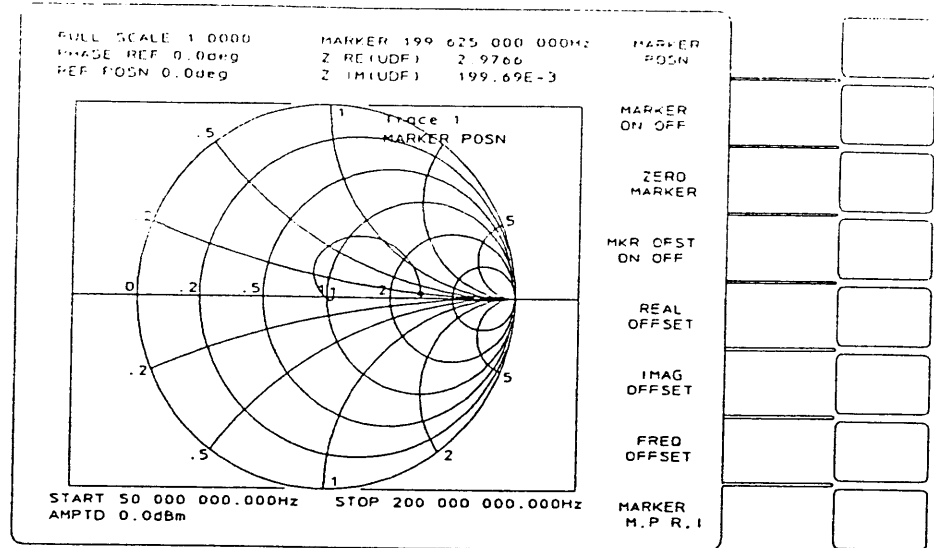

Figure 2-44. The Smith Chart

Note



The Smith chart graticule should be used with a FULL SCALE value of 1.000 units. If this scale is changed the graticule may not be used for conversion to complex impedance, but the data in the marker information block will continue to be accurate.

Chapter 3

Remote Operation

Remote Operation

The Hewlett-Packard Interface Bus

What is the HP-IB?

The Hewlett-Packard Interface Bus (HP-IB) is an easy to use, high performance bus structure that links the HP 3577A, desktop computers, minicomputers and other instruments into automated measurement systems. The HP-IB is Hewlett-Packard's implementation of the IEEE Standard 488-1978, ANSI Standard MC 1.1 and IEC Recommendation 625-1.

How does the HP-IB Operate?

All of the active interface circuits are contained within the various HP-IB controlled devices. The cable's role is limited to connecting all of the devices in parallel so that data can be transferred from one device to another.

Every participating device must be able to perform at least one of the following roles: TALKER, LISTENER, or CONTROLLER. A talker transmits data to other devices called listeners. Most devices can perform both roles, but not at the same time. A controller manages the operation of the bus system by designating which device is to talk and which device(s) are to listen at any given time. The HP 3577A can be a talker or a listener. It has no controller capabilities.

The minimum HP-IB system consists of one talker and one listener without a controller. In this configuration, data transfer is limited to one direction because one device must be manually set to "TALK ONLY" and the other device must be manually set to "LISTEN ONLY." The HP 3577A can be set to talk only; it cannot be set to listen only.

The full flexibility and power of the HP-IB bus is realized when a controller is added to the system. An HP-IB controller participates in the measurement by being programmed to:

- Schedule measurement tasks
- Set up instruments
- Monitor the measurement
- Interpret and operate upon the results

HP-IB Specification Summary

Number of Interconnected Devices:

A maximum of fifteen on one bus.

Interconnection Path/maximum Cable Length:

Total cable length equal to two meters times number of devices or twenty meters, whichever is less, with a maximum of three meters separating any two devices.

Message Transfer Scheme:

Byte-serial, eight bit-parallel asynchronous data transfer using a three wire handshake.

Data Rate:

One megabyte per second (maximum) over limited distances, actual data rate depends upon the capability of the slowest device involved in the transmission.

Address Capability:

Primary addresses: 31 talk, 31 listen. A maximum of one talker and fourteen listeners at one time.

Multiple Controller Capability:

In systems with more than one controller, only one can be active at a time. The active controller can pass control to another controller, but only the system controller can assume unconditional control. Only one system controller is allowed. The system controller is hard-wired to assume bus control after a power failure.

Bus Structure

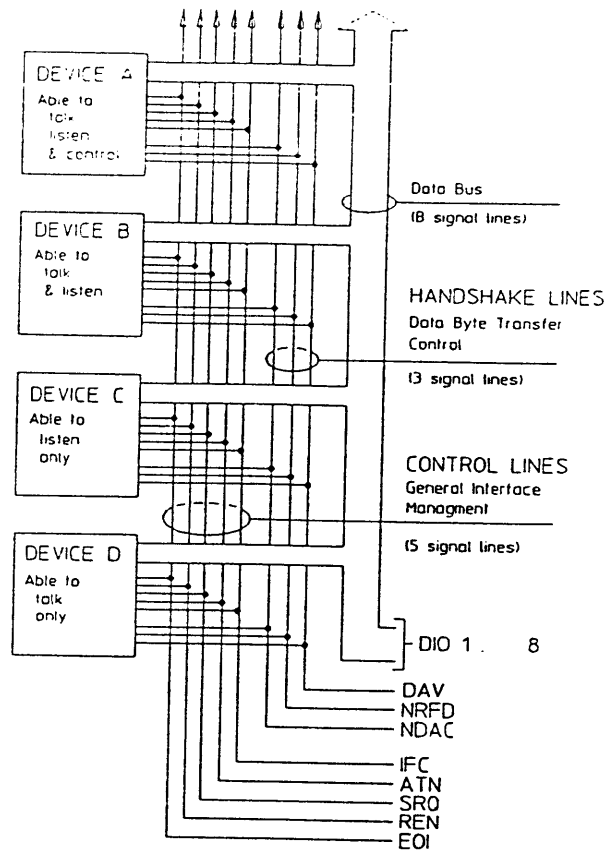

Figure 3-1. Bus Structure

Management (CONTROL) Lines.

ATN — Attention. This line is used by the active controller to define how information on the data lines (DIO 1...8) will be interpreted by the other devices on the bus. When ATN is low (true) the HP-IB is in Command Mode and the data lines carry bus commands. When ATN is false the HP-IB is in Data Mode and the data lines carry device dependent commands. In the command mode the controller is active and all other devices are waiting for instructions.

SRQ — Service Request. This line is set low (true) by any instrument requesting service.

REN — Remote Enable. The system controller sets REN low and then addresses the devices to listen before they will operate under remote control.

IFC — Interface Clear. Only the system controller can activate this line. When IFC is set (true) all talkers, listeners, and active controllers go to their inactive states.

EOI — End Or Identify. This line is used to indicate the end of a multiple byte transfer sequence or, in conjunction with ATN, to execute a parallel polling sequence.

The HP 3577A and the HP-IB

HP 3577A HP-IB Capability

As defined by IEEE Standard 488-1978, the HP 3577A has these characteristics:

SH1	Complete Source Handshake capability
AH1	Complete Acceptor Handshake capability
T5	Basic Talker; serial poll; unaddress if MLA; Talk-Only
TE0	No Extended Talker capability
L4	Basic Listener; unaddress if MTA; no Listen Only
LE0	No Extended Listener capability
SR1	Complete Service Request capability
RL1	Complete Remote/Local capability
PP1	Parallel Poll; remote configuration capability
DC1	Complete Device Clear capability
DT1	Complete Device Trigger capability
C0	No Controller capability
E1	Drivers are open-collector

This list of capabilities is printed on the rear panel near the HP-IB connector as follows:

SH1 AH1 T5 TE0 L4 LE0 SR1 RL1 PP1 DC1 DT1 C0 E1

Data Format Vs Transfer Rate

The HP 3577A offers three data formats for transferring certain types of data on the bus. Data format may be selected for the following I/O: trace dumps, register dumps and loads, marker data dumps, and marker position dumps. A trace is made up of real numbers and is defined by the INPUT key. Trace one or trace two may be dumped (output) in any of the three data formats. A register is made up of real and imaginary numbers. There will be twice as many numbers in a register I/O as there are for a trace dump with the same sweep resolution. Registers R, A, B, D1, D2, D3, or D4 may be dumped or loaded in any of the three data formats.

As described in the previous paragraph, not all HP 3577A dump and load commands may be done in more than one type data format. It is recommended that the ASCII format (FM1) be active unless one of these transfers is required. Each data format has a different data transfer rate. The figures listed for transfer rate are average times, shown here for comparison. They were taken such that the controller was not a limiting factor.

FM1 — Data format one is the default data format. When FM1 is active the HP 3577A transfers data using the ASCII format. Using this format the HP 3577A can dump a trace of 401 points in approximately 1.6 seconds. This format has the slowest data transfer rate of the three.

FM2 — Data format two is the 64 bit floating point binary specified in the IEEE draft standard P754. The data rate for this format is faster than that of FM1 but slower than that of FM3. FM2 has the advantage of being the same format used by HP 9000 Series 300 computers. Using this format the HP 3577A can dump a trace of 401 points in approximately 0.16 seconds.

FM3 — Data format three is the 32 bit floating point binary used by the HP 3577A fast processor. FM3 has the fastest data transfer rate of the three data formats. Using FM3 the HP 3577A can dump a trace of 401 points in approximately 0.04 seconds. When this format is active the HP 3577A does not have to convert data formats and requires half as many transfers per data value as FM2. This format may be used for data that is not processed outside the HP 3577A.

Remote Operation
The HP 3577A and the HP-IB

Direct Plotting

The HP 3577A can provide a hardcopy of the CRT screen without using a computer. It does this by directly controlling a digital plotter connected to the HP 3577A's HP-IB port located on the rear panel. The plotter (such as the HP 7475A) must accept Hewlett-Packard Graphic Language (HP-GL) commands. The HP 3577A must be configured in a Talk Only mode and the plotter must be configured as a Listen Only device. Refer to SPECIAL FUNCTIONS in the REFERENCE section.

HP-IB Verification

Refer to the computer operating manual and find the section describing the HP-IB REMOTE Message. When this message is sent to the HP 3577A, the REMOTE annunciator LED on the front panel will light. If this does not occur, recheck the cabling, the HP 3577A address, and the syntax of the computer statement. Here is an example of the REMOTE message as implemented by the HP 9000 Series 300 computer:

REMOTE 711

HP 9000 Series 300 Computer

HP-IB Diagnostic Mode

The Bus Diagnostic Modes (BD1 & BD2) may be used to find HP-IB program problems. When active, these modes cause the HP 3577A to display menus as though being operated from the front panel. In BD2 the programming code received by the HP 3577A over the bus will be left-shifted through the screen error block in a "ticker tape" fashion.

BD0 is the default mode. Bus diagnostics are off; no menus appear and bus codes are not displayed. Sweep dot does not appear unless sweep time is 1 second or more. This is the fastest programming mode.

BD1 displays all menus and updates the front panel as though the HP 3577A were being operated from the front panel. The HP-IB programming codes appear only when an error is encountered. When this occurs, processing of all bus commands will halt for three seconds to allow the programmer to read the code that caused the error before processing continues and secondary errors are generated.

BD2 is the same as BD1 except that the HP 3577A processes bus code at a reduced rate (one command per second) and all programming code received on the bus is left-shifted through the screen error block.

Note



The HP 3577A will interpret the carriage return (CR) as ←, linefeed as ↓, and EOI as ^. Binary loads (including the #I) and ASCII register loads are not shown on the screen.

Note



The HP 3577A's HP-IB buffer will hold a maximum of 100 characters. If the controller tries to send more than 100, it will have to wait for the HP 3577A to process some of the code before sending more. If the computer is waiting as just described, and the HP 3577A processes a dump command, it will wait to be addressed to talk. It is possible that both controller and HP 3577A could end up waiting for each other, halting all bus activity. Care should be taken in programming such that this does not occur.

The HP 3577A's HP-IB Address

Talk/listen Addresses

Every HP-IB device has at least one address unless it's totally transparent or a Talk-Only or Listen-Only device. Device addresses are used by the active controller in the COMMAND MODE (ATN true) to specify who talks (via a Talk Address) and who listens (via Listen Addresses). There may be only one talker addressed (by the controller) to talk at any time. Talk and Listen addresses are the same on the HP 3577A.

Viewing the HP 3577A's HP-IB Address

The HP 3577A's HP-IB address is set to eleven (11) at the factory. To display the address of the HP 3577A:

1. Press the "SPCL FCTN" hardkey
2. Press the "HP-IB ADDRESS" softkey (top item in the display menu). The address will appear in the entry block. See figure 3-2.

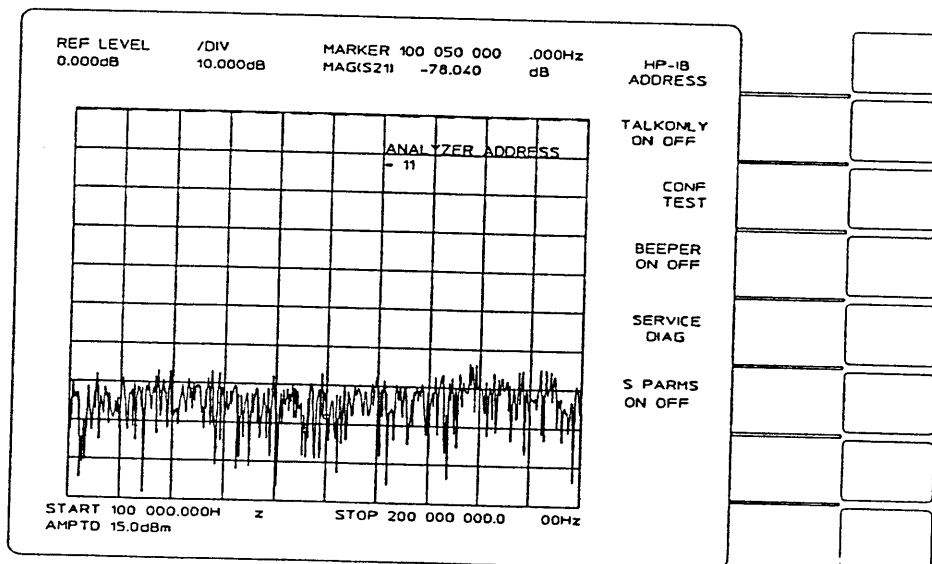

Figure 3-2.

Setting the HP 3577A 's HP-IB Address

Every device on the HP-IB must have a unique address. The HP 3577A address can be set to any address from zero (0) to thirty (30), inclusive. When choosing an address, remember that the controller also has an address (typically 21). To change the HP-IB address:

1. Press the "SPCL FCTN" hardkey
2. Press the "HP-IB ADDRESS" softkey to display the current HP-IB address.
3. Press the appropriate keys in the numeric keypad for the new address. Note the change in the entry block.
4. Press the "ENTER" softkey.

The HP 3577A's HP-IB address is stored in a non-volatile memory; there are no address switches. If the contents of this memory are destroyed, the HP-IB address defaults to eleven (11). Under normal circumstances, the non-volatile memory should retain its data for up to five years. This time is not specified and no warranty is stated or implied.

Use the following table if you are using a controller that requires the talk and listen addresses.

Remote Operation
 The HP 3577A's HP-IB Address

HP-IB ADDRESSES		
DEVICE ADDRESSES	TALK	LISTEN
0	@	SPACE ‡
1	A	!
2	B	"
3	C	#
4	D	\$
5	E	%
6	F	&
7	G	'
8	H	(
9	I)
10	J	*
11‡	K	+
12	L	,
13	M	-
14	N	.
15	O	/
16	P	0
17	Q	1
18	R	2
19	S	3
20	T	4
21 ‡‡	U	5
22	V	6
23	W	7
24	X	8
25	Y	9
26	Z	:
27	[;
28	1/2	<
29]	=
30	^	>

‡ (ASCII character) ‡‡ (HP 3577B factory setting) ‡‡‡ (usually the controller)

The Talk and Listen addresses are ASCII characters. When a device receives one of these characters while ATN is true, it will become addressed. The ASCII character ? will unaddress all devices. The Device address (set from the HP 3577A front panel) is used by most newer HP-IB computers which automatically send the Talk and Listen address characters.

Bus Messages

The interface system operates in either of two modes: COMMAND MODE (ATN true) or DATA MODE (ATN false). If an HP computer is used, the bus management lines will be configured automatically and all necessary command strings will be issued.

Bus Commands

In the Command Mode special codes known as "bus commands" may be placed on the HP-IB. These commands have the same meaning in all HP-IB systems. Each device is designed to respond to those commands that have a useful meaning to the device and ignore other bus commands. The HP 3577A will respond to the following commands as described. The three-letter command abbreviations refer to IEEE 488 nomenclature.

Abort I/O

Abort Input/Output (IFC; interface clear) is an unconditional assumption of control of the bus by the system controller. All bus activity halts and the HP 3577A becomes unaddressed. This does not clear the HP 3577A HP-IB command buffer.

Example for HP 9000 Series 300 computers, in BASIC:

```
ABORT 7
```

Clear Lockout/Set Local

This command removes all devices from the local lockout mode and returns them to local (front panel) control. The only difference between this bus message and the LOCAL message is how it is addressed.

Example for HP 9000 Series 300 computers, in BASIC:

```
LOCAL 7  
(Clears LOCAL LOCKOUT and enables front panel keys)
```

Device Clear

The CLEAR command may be addressed (SDC, selected device clear) or unaddressed (DCL; device clear). When this command is received by the HP 3577A it will clear the HP-IB command buffer, reset the SRQ line (if pulled low by the HP 3577A), and abort any data input or output. This interrupts bus activity and gains control of the analyzer, no matter what it may be doing. It does not preset the HP 3577A. It is good practice to begin programs with this command. See the examples that follow.

Examples for HP 9000 Series 300 computers, in BASIC:

CLEAR 7
(UDC; clears all devices on computer port seven)

CLEAR 711
(SDC; clears device addressed eleven on port seven)

Local

LOCAL (GTL; go to local) returns control of the listening device to the local (front panel) state. The REMOTE LED on the front panel extinguishes if the instrument was in remote prior to the LOCAL command. The HP-IB buffer is not cleared on the HP 3577A. Also, any dump or load in progress will **not** be aborted.

Example for HP 9000 Series 300 computers, in BASIC:

LOCAL 711
(Local lockout still active if returned to REMOTE).

Note



This command is **not** identical to pressing the LCL front panel key on the HP 3577A. Pressing the key will clear the HP-IB buffer of all pending commands.

Local Lockout

LOCAL LOCKOUT (LLO) disables the LOCAL key of all devices on the bus to secure the system from operator interference when in remote control. After this command is issued the only way to return to front panel operation from remote control is with a LOCAL command from the controller. Local lockout will not change the local/remote status of the instrument. Local lockout is disabled by a universal (unaddressed) LOCAL command on the bus.

Example for HP 9000 Series 300 computers, in BASIC:

LOCAL LOCKOUT 7

Parallel Poll

PARALLEL POLL is a command issued by the controller in response to the SRQ (service request) management line being pulled low (true). Since any instrument could have pulled SRQ the controller must poll them all to find which requested service. The parallel poll commands each device to send its Request Service bit (RQS; part of the Status Byte) on one of the eight data lines. The Parallel Poll Configure (PPC) command determines data line and logical sense used.

Example for HP 9000 Series 300 computers, in BASIC:

```
Var=PPOLL(7)
```

Parallel Poll Configure

The PARALLEL POLL CONFIGURE command (PPC) programs the logical sense and data line used by a specified device to respond to a parallel poll. The configure word is coded as shown in figure 3-3. The three least significant bits determine the data bus line for the response. The fourth bit determines the logical sense of the response.

Decimal	Binary
2	0 010
9	1 001

Figure 3-3

Example for HP 9000 Series 300 computers, in BASIC:

```
PPOLL CONFIGURE 711;2  
(put RQS bit on DIO line 2 Sense: 0 = RQS true)
```

```
PPOLL CONFIGURE 711;9  
(put RQS bit on DIO line 1 Sense: 1 = RQS true)
```

Pass Control

Pass Control (TCT; take control) shifts system control from one controller to another. Since the HP 3577A has no controller capability, it cannot respond.

Remote

REMOTE may be used to address the HP 3577A to listen. When this command is issued, the REMOTE front panel LED illuminates and the front panel is disabled except for the LCL key. If LOCAL LOCKOUT is active the LCL front panel key is also disabled.

Examples for HP 9000 Series 300 computers, in BASIC:

```
REMOTE 7
```

(switches all devices on port seven from local to remote)

```
REMOTE 711
```

(switches device addressed eleven from local to remote)

Serial Poll

SERIAL POLL is a command to dump the status byte on the bus. Encoded in the eight bits of the status byte are the states of several HP 3577A operating conditions. See "THE STATUS BYTE."

Examples for HP 9000 Series 300 computers, in BASIC:

```
Var=SPOLL(711)
```

```
IF Var THEN...
```

(Checks for the zero state)

Another example:

```
IF BINAND(SPOLL(711),16) THEN...
```

(Checks state of bit five)

Service Request

The Service Request (SRQ) line is one of the five bus management lines that go to every device on the bus, along with eight data lines and three handshake lines. It may be used by one or more devices to indicate the need for attention from the controller and can act as an interruption of the current sequence of events. Typically, SRQ indicates information is ready to transmit and/or an error condition exists. When the HP 3577A issues an SRQ it also sets bit #6 of the Status Byte. Bit 6 is the RQS (Require Service) bit, sometimes referred to as the "status bit" in connection with a poll.

If properly configured, the controller will stop and poll when it senses the SRQ. A serial poll returns each device's status byte, one device at a time. A parallel poll returns all (up to eight) device's status bits simultaneously; each instrument responding on one of the eight data lines. When the HP 3577A is polled it will clear the RQS bit and the SRQ line.

Any of the bits in the Status Byte may initiate an SRQ. The Status Byte may be masked such the user may select which bits cause the HP 3577A to set the SRQ line (see the Status Byte).

Trigger

The HP 3577A responds to the TRIGGER bus command (GET; group execute trigger) as it would to any other external trigger; by beginning a sweep or, in the case of CW sweep type or manual sweep mode, taking a measurement. TRIGGER may be sent to a selected device or all devices addressed to listen on the HP-IB. The HP 3577A must be addressed to listen and in the "WAIT TRIG" state before the trigger message is sent. If the last statement left the HP 3577A addressed to listen and settling is complete, it's ready for a trigger. If not, or if several devices are to be triggered simultaneously, use a SEND command to address the listeners. See Bit B4 of The Status Byte.

Examples for HP 9000 Series 300 computers, in BASIC:

```
SEND 7;UNL MTA LISTEN 11, 17, 22
TRIGGER 7
```

UNL = UNLISTEN; unaddresses all listeners
MTA = MY TALK ADDRESS; the controller addresses itself to talk
LISTEN 11, 17, 22; addresses devices whose addresses are 11, 17, and 22 to listen

Another example:

```
ASSIGN @Listeners TO 702, 707, 711
TRIGGER @Listeners
```

Device Dependent Commands

In the Data Mode special codes known as "device dependent commands" may be placed on the HP-IB. These commands have meaning for a specific instrument. They can configure the instrument, tell it to take a measurement, dump or load data, or define error reporting conditions, and are meaningless for other instruments.

Device dependent commands and front panel key functions have a one-to-one relationship for all but the HP-IB-only commands. For example, DF5 is the remote equivalent of pressing the PHASE softkey in local. Exceptions to this rule are:

- Front panel functions not allowed in remote operation: HP-IB Address Viewing and Selection TALK ONLY mode ON/OFF

Remote functions not allowed from the front panel:

- Data Dumps
- Load Data
- User defined graphics
- User defined annotation
- User defined menus
- Bus code diagnostics
- Control of Settling Time value

Remote Operation
Bus Messages

Device dependent commands may be sent to the HP 3577A by using the BASIC command "OUTPUT" as shown in the following examples for HP 9000 Series 300 computers:

```
OUTPUT 711;"FSW;"           (Full Sweep)
OUTPUT 711;"DF5;"           (Display Function 5 is PHASE)
OUTPUT 711;"FRA 2 MHZ;"     (Start Frequency - 2 MHz)
OUTPUT 711;"DRA;"           (Dump Register A)

OUTPUT 711;"DF7;FRA 1 MHZ;FRB 10 MHZ;SAM 0 DBM;TKM;DRA;"
```

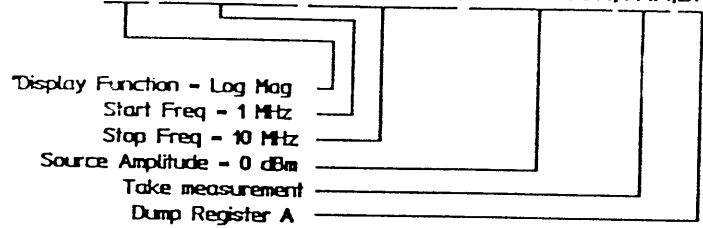

A delimiter should be used after all commands when there are multiple commands per line. Delimiters are semicolons (;), linefeeds (LF), and <EOI> (pulling the EOI bus management line). Separators, such as spaces and commas, may be used instead of delimiters, but using semicolons or LF characters between commands enables the HP 3577A to do a better job of error reporting. A delimiter is required to terminate a numeric entry. The HP 3577A accepts upper or lower case letters over the bus.

Definitions

A **SELECT COMMAND** is a two-letter prefix followed by a qualifier digit that selects a particular state of that function.

Example:

The HP-IB code for PHASE (display function 5) is DF5

IMMEDIATE EXECUTION COMMANDS execute a given operation when issued. They require no other data.

Example: Instrument Preset is IPR.

DATA ENTRY COMMAND is a three part command that enters a value for one of the parameters. The three parts are: prefix (the parameter to be changed by the data entry), data (numbers), and suffix (units for the new value). Source amplitude (SAM) is an example of a data entry command.

Example: OUTPUT 711;"SAM 0 DBM;"

HP 3577A Program Codes have been categorized into five distinct groups to help explain them. These are:

- SOURCE
- RECEIVER
- DISPLAY FORMAT
- INSTRUMENT STATE
- HP-IB ONLY

Display Format

Function	HP-IB code
TRACE 1	TR1
TRACE 2	TR2
DISPLAY FUNCTION	DSF *
Log Magnitude	DF7
Linear Magnitude	DF6
Phase	DF5
Polar	DF4
Real	DF3
Imaginary	DF2
Delay	DF1
Trace Off	DF0
Delay Aperture menu	DAP *
Aperture .5% of span	AP1
Aperture 1% of span	AP2
Aperture 2% of span	AP3
Aperture 4% of span	AP4
Aperture 8% of span	AP5
Aperture 16% of span	AP6
Return	RET *
INPUT	INP *
Input = R	INR
Input = A	INA
Input = B	INB
Input = A/R	IAR
Input = B/R	IBR
Input = D1	ID1
Input = D2	ID2
Input = D3	ID3
Input = D4	ID4
Return	RET *

Function	HP-IB code
User Defined Input	UDI
Input = S11	I11
Input = S21	I21
Input = S12	I12
Input = S22	I22
Copy Input	CP1
Test Set Forward	TSF
Test Set Reverse	TSR
SCALE	SCL *
Autoscale	ASL
Reference Level (entry)	REF
Scale/DIV (entry)	DIV
Reference Position (entry)	RPS
Reference Line Off	RLO
Reference Line On	RL1
Copy Scale	CPS
Phase Slope (entry)	PSL
Phase Slope Off	PS0
Phase Slope On	PS1
Polar Full Scale (entry)	PFS
Polar Phase Ref (entry)	PPR
Smith Chart Off	GTO
Smith Chart On	GT1
MARKER	MKR *
Marker Position (entry)	MKP
Marker Off	MR0
Marker On	MR1
Zero Marker	ZMK
Marker Offset Off	M00
Marker Offset On	M01

* Use not required. The only function of this code is to display a menu (if bus diagnostics are on).

Function	HP-IB code
Marker Offset (entry)	MKO
Marker Offset Freq (entry)	MOF
Marker Offset Amp (entry)	MOA
Marker Coupling Off	COO
Marker Coupling On	CO1
Polar Mag Offset (entry)	PMO
Polar Phase Offset (entry)	PPO
Polar Real Offset (entry)	PRO
Polar Imag Offset (entry)	PIO
Polar Marker Units (Re/Im)	MRI
Polar Marker Units (Mg/Ph)	MMP
MARKER →	MKG*
MKR → Reference Level	MTR
MKR → Start Frequency	MTA
MKR → Stop Frequency	MTB
MKR → Center Frequency	MTC
MKR Offset → Span	MOS
MKR → Max	MTX
MKR → Min	MTN
MKR Target value (entry)	MTV
MKR → Right for Target	MRT
MKR → Left for Target	MLT
Return	RET *
MKR → Full Scale	MTP
MKR → Polar Phase Ref	MPF
STORE DATA	ST0 *
Store in register D1	SD1
Store in register D2	SD2
Store in register D3	SD3
Store in register D4	SD4
Store and Display	STD
User Defined Store	UDS

Function	HP-IB code
Store to D1	TD1
Store to D2	TD2
Store to D3	TD3
Store to D4	TD4
MEASUREMENT CALIBRATION	CAL *
Normalize	NRM
Normalize (Short)	NRS
Calibrate, Partial	CPR
Calibrate, Full	CFL
Continue Calibration	CGO
DEFINE MATH	DFN *
Constant K1, Real(entry)	KR1
Constant K1, Imaginary(entry)	KI1
Constant K2, Real(entry)	KR2
Constant K2, Imaginary(entry)	KI2
Constant K3, Real(entry)	KR3
Constant K3, Imaginary(entry)	KI3
Define Function	DFC *
Function F1	UF1
Function F2	UF2
Function F3	UF3
Function F4	UF4
Function F5	UF5
Math term for input R	R
Math term for input A	A
Math term for input B	B
Math term for storage reg	D
Math term for constant	K
Math term for function	F
Math bracket	(
Math function plus	+
Math function minus	-

* Use not required. The only function of this code is to display a menu (if bus diagnostics are on).

Remote Operation
Display Format

Function	HP-IB code
Math function multiply	*
Math function divide	/
Math bracket)
Return	RET *
DATA ENTRY SECTION COMMANDS	
Increment (up arrow)	IUP
Decrement (down arrow)	IDN
Continuous Entry (knob) Off	CE0
Continuous Entry (knob) On	CE1
Entry Off	HLD
DISPLAY FORMAT SUFFIX UNITS	
dBm	DBM
dBv (rms)	DBV
dB relative	DBR
Volt (rms)	V
milli-Volt (rms)	MV
micro-Volt (rms)	UV
nano-Volt (rms)	NV
degrees	DEG
degrees/span	DSP
radians	RAD
radians/span	RSP
seconds	SEC
milliseconds	MSC
microseconds	USC
nanoseconds	NSC
percent	%
degrees/span	DSP
radians/span	RAP
MHZ	MHZ
KHz	KHZ
Hz	HZ
exponent	E

* Use not required. The only function of this code is to display a menu (if bus diagnostics are on).

USER DEFINED INPUT (UDI) uses the same terms and math functions as UDF (user defined function).

Example: 10 OUTPUT 711;"UDI (B/R)/(K1-B/R)"

COPY INPUT (CPI) will copy the INPUT definition of the inactive trace into that of the active trace as follows:

1. Trace one active
2. Output CPI
3. INPUT definition of trace one is now the same as trace two

TEST SET FORWARD AND REVERSE (TSF & TSR) are used to configure the HP 35677 A/B S-Parameter Test Set connected to the HP 3577A. The INPUT definition should be user defined (to avoid an error message). If you wish to control the test set while using one of the standard input definitions, enter it under UDI.

Example: 10 OUTPUT 711;"UDI R;TSR;"

COPY SCALE (CPS) will copy reference level and /DIV parameters of the inactive trace into those of the active trace if the DISPLAY FUNCTION units of both traces are compatible.

MARKER POSITION (MKP) is a prefix for a data entry. The data will be a bin number. The number of bins in a sweep depends on the sweep resolution (in a frequency sweep) or number of steps (in an amplitude sweep). The default numbers of bins in a sweep are 401 (0 through 400) for frequency sweeps and 101 (0 through 100) for amplitude sweeps. MKP is the prefix used to position the marker at a specific bin. This bin number may be calculated using the following formula:

$$\text{Bin number} = \frac{f_{\text{bin}} - f_{\text{start}}}{\text{span}} \times (\text{points per sweep})$$

Where:

- f_{bin} is the frequency of the new marker position
- f_{start} is the start frequency
- span is the frequency span
- points per sweep is the sweep resolution

This number *should* be an integer ≤ 401 . If the result is not an integer you probably picked a frequency for f_{bin} that is not one of the sampled frequencies for the sweep. The HP 3577A will round any fraction received with MKP. If the number is > 401 a "NUMBER OUT OF RANGE" error message will be generated.

USER DEFINED STORE (UDS) and TD1-TD4 are used together to define and store data (traces).

Example: 10 OUTPUT 711, "UDS D3-A/R*D4 TD3,"

Note that a register name may appear as part of the definition and as the destination register. A destination register must appear after the definition

USER DEFINED FUNCTIONS 1 THROUGH 5 (UF1-UF5) are used to enter definitions as shown in the following:

Example:

10 OUTPUT 711;"UF3 D4*A/R+ D3;"

20 OUTPUT 711;"UF4 (A/R-D2)/F3;"

Note that functions may be defined in terms of lower numbered functions. Thus F1 cannot be a function of another user defined function but F5 could be a function of any of the first four.

CONTINUOUS ENTRY OFF/ON (CE0 & CE1) corresponds to the MARKER and ENTRY modes of the knob where CE0 = MARKER and CE1 = ENTRY.

Source

Function	HP-IB code
SWEEP TYPE	STY *
Linear Sweep	ST1
Alternate Sweep	ST2
Log Sweep	ST3
Amplitude Sweep	ST4
CW	ST5
Discrete Sweep	ST6
Sweep Direction Up	SUP
Sweep Direction Down	SDN
SWEEP MODE	SMD*
Continuous	SM1
Single Sweep	SM2
Manual Sweep	SM3
Manual Frequency (entry)	MFR
Manual Amplitude (entry)	MAM
Marker → Manual	MTM
SWEEP TIME	STM *
Sweep Time (entry)	SWT
Step Time (entry)	SMT
Sample Time (entry)	MSR
FREQUENCY	FRQ *
Source Frequency (entry)	SFR
Start Frequency (entry)	FRA
Stop Frequency (entry)	FRB
Center Frequency (entry)	FRC
Frequency Span (entry)	FRS
FRC Step size (entry)	CFS
Sweep Resolution menu	SRL *
Freq Swp Res 51 pts/span	RS1
Freq Swp Res 101 pts/span	RS2
Freq Swp Res 201 pts/span	RS3

Function	HP-IB code
Freq Swp Res 401 pts/span	RS4
Return	RET *
Full Sweep	FSW
Freq Step Size (entry)	FST
AMPLITUDE	AMP*
Source Amplitude (entry)	SAM
Amp Step Size (entry)	AST
Clear Trip, Source	CTS
Start Amplitude (entry)	AMA
Stop Amplitude (entry)	AMB
Steps/Sweep menu	NST *
Number of steps = 6	NS1
Number of steps = 11	NS2
Number of steps = 21	NS3
Number of steps = 51	NS4
Number of steps = 101	NS5
Number of steps = 201	NS6
Number of steps = 401	NS7
Return	RET *
Full Sweep	FSW
TRIGGER MODE	TRM *
Free Run	TG1
Line Trigger	TG2
External Trigger	TG3
Immediate	TG4
SWEEP TRIGGER TRG/ SWEEP RESET RESET	TRG RST
SOURCE SUFFIX UNITS	
dBm	DBM
dBV (rms)	DBV
Volt (rms)	V
milli-Volt (rms)	MV

* Use not required. The only function of this code is to display a menu (if bus diagnostics are on).

Remote Operation
Bus Messages

Function	HP-IB code
micro-Volt (rms)	UV
nano-Volt (rms)	NV
seconds	SEC
milliseconds	MSC
MHz	MHZ
kHz	KHZ
Hz	HZ
exponent	E

* Use not required. The only function of this code is to display a menu (if bus diagnostics are on).

STEP TIME (SMT) is a data entry prefix for sample time used for amplitude sweeps. The default value for this parameter is 0.05 seconds per step:

Example:

```
10 OUTPUT 711;"ST4;SMT .1 SEC;" ! ST4 is amptd sweep
```

SAMPLE TIME (MSR) is a data entry prefix for sample time for the manual sweep mode and CW sweep type. The default value for this parameter is 0.05 seconds per sample.

Example:

```
10 OUTPUT 711; "SM3;MSR .1 SEC;" ! SM3 = Manual sweep mode
```

FREQUENCY STEP SIZE (FST) is a data entry prefix used only when the source is operated at a single frequencies as with CW or amplitude sweep types or the manual frequency sweep mode.

TRIGGER AND RESET (TRG & RST) Where the front panel has one key, labeled TRIG/RESET, functioning as both trigger (for single sweeps) and reset, the HP-IB has separate commands for each function. Sweep control is done the same in remote as local. RST resets the sweep in all sweep modes, and TRG may be used to trigger single sweeps. RST also initiates settling even if more commands are waiting in the HP-IB buffer. Other commands do not initiate settling until the command buffer is empty. RST is useful for decreasing the time required to prepare for a sweep by overlapping settling and other HP-IB operations.

Remote Operation:
Bus Messages

Example:

```
10  !
20  ! 'RST', 'TRG' Use of Reset and Trigger commands
30  !
40  ! This example program will take measurements at 1, 2, 3, 4, and
50  ! 5 MHz and dump the data to the computer.
60  !
70  ! First, set up the instrument state and take a measurement
80  !
90  OUTPUT 711;" PR;ST5;SM2;SFR 1 MHz;TKM;" ! Set up 1st freq
100 FOR I =2 TO 5
110   LOOP
120     EXIT IF BINAND(SPOLL(711),4) ! 4= B2 of Status Byte
130     END LOOP ! Loop until Meas is
140 ! Complete
150 !
160 OUTPUT 711; "SFR;" ;I; "MHz;RST;DM1;TRG;" ! Start settling for
170 ENTER 711;Mkr_Mag ! next meas and dump
180 ! data for previous
190 ! meas. This allows
200 ! settling to occur
210 ! during the data dump
220 !
230 PRINT "MARKER MAGNITUDE AT" ;I-1; "MHz =" ;Mkr_Mag; "dB"
240 !
250   NEXT I ! When this FOR/NEXT
260 ! loop is done 5 MHz
270 ! has been set up but
280 ! no data dumped.
290   LOOP
300     EXIT IF BINAND(SPOLL(711),4) ! Wait for Meas
310     END LOOP ! Complete, again
320 OUTPUT 711; "DM1;" ! Dump 5 MHz data
330 ENTER 711;Mkr_Mag
340 PRINT "MARKER MAGNITUDE AT" ;I-1; "MHz =" ;Mkr_Mag; "dB"
350 END
```

Receiver

Function	HP-IB Code
RESOLUTION BW	RBW *
Resolution BW 1 Hz	BW1
Resolution BW 10 Hz	BW2
Resolution BW 100 Hz	BW3
Resolution BW 1 kHz	BW4
Auto Bandwidth Off	AU0
Auto Bandwidth On	AU1
AVERAGE	AVE *
Averaging Off	AV0
N=4	AV1
N=8	AV2
N=16	AV3
N=32	AV4
N=64	AV5
N=128	AV6
N=256	AV7
ATTENUATION	ATT *
Attenuation R = 0 dB	AR1
Attenuation R = 20 dB	AR2
Attenuation A = 0 dB	AA1
Attenuation A = 20 dB	AA2
Attenuation B = 0 dB	AB1
Attenuation B = 20 dB	AB2
Impedance R = 50Ω	IR1
Impedance R = 1 MΩ	IR2
Impedance A = 50Ω	IA1
Impedance A = 1 MΩ	IA2
Impedance B = 50Ω	IB1
Impedance B = 1 MΩ	IB2
Clear Trip, Receiver	CTR

Function	HP-IB Code
LENGTH	LEN *
Length R (entry)	LNR
Length R Off	LRO
Length R On	LR1
Length A (entry)	LNA
Length A Off	LA0
Length A On	LA1
Length B (entry)	LNB
Length B Off	LB0
Length B On	LB1
Length Step Size (entry)	LNS
RECEIVER SUFFIX UNITS	
meters	MET
centimeters	CM
seconds	SEC
milliseconds	MSC
microseconds	USC
nanoseconds	NSC
exponent	E

* Use not required. The only function of this code is to display a menu (if bus diagnostics are on).

Instrument State

Function	HP-IB Code
SPECIAL FUNCTIONS	SPC *
Confidence test menu	SLF *
Confidence test channel R	STR
Confidence test channel A	STA
Confidence test channel B	STB
Return	RET *
Beeper off	BP0
Beeper on	BP1
Service Diagnostics menu	SDG *
Source Leveling off	SLO
Source Leveling on	SL1
Settling Time off	SEO
Settling Time on	SE1
Synthesizer Diag off	SY0
Synthesizer Diag on	SY1
Display Test Pattern	DTP
Trace Memory Test	TMT
Fast Processor Test	FPT
I/O Test	PRT
More Serv Diag menu	MOR *
Display Memory Test	DST
Software Revision message	SRV
Return	RET *
S-Parameters Off	SP0
S-Parameters On	SP1
SAVE INSTRUMENT STATE	SAV *
Save state in register 1	SV1
Save state in register 2	SV2
Save state in register 3	SV3
Save state in register 4	SV4
Save state in register 5	SV5

Function	HP-IB Code
RECALL INSTRUMENT STATE	RCL *
Recall old (last) state	RLS
Recall register 1	RC1
Recall register 2	RC2
Recall register 3	RC3
Recall register 4	RC4
Recall register 5	RC5
INSTRUMENT PRESET	IPR
PLOT MENU	PLM *
Plot all	PLA
Plot trace 1	PL1
Plot trace 2	PL2
Plot graticule	PLG
Plot characters	PLC
Plot trace 1 marker	PM1
Plot trace 2 marker	PM2
Configure Plot menu	CPT *
Trace 1 linetype (entry)	T1L
Trace 2 linetype (entry)	T2L
Trace 1 pen number (entry)	T1P
Trace 2 pen number (entry)	T2P
Graticule pen no. (entry)	PGP
Pen speed fast (max)	PNM
Pen speed slow	PNS
Set plot config. to default	PLD
Plotter address (entry)	HBP
Return	RET *

* Use not required. The only function of this code is to display a menu (if bus diagnostics are on).

Plotting Via HP-IB

HP-IB PLOT commands are a special programming case. To control a plotter directly, the HP 3577A must become a talker. Only one talker is allowed on the bus at a time so the controller must be programmed to release the bus. The HP 3577A must be manually configured with TALK ONLY OFF, as with any remote control operation. The following examples execute a PLOT ALL command. They assume that the analyzer's address is eleven and the plotter's address is thirty.

Example for the HP 9000 Series 300 computers:

```
10 SEND 7; UNL MTA LISTEN 11 DATA "PLA" UNL MTA TALK 11  
LISTEN 30 DATA
```

SEND 7 — selects the HP-IB interface at address seven

UNL — unlisten, unaddresses all listeners

MTA — my talk address, controller addresses itself to talk, this command will also unaddress all talkers

LISTEN 11 — addresses device at address eleven to listen

DATA "PLA" — outputs the characters in quotes on the HP-IB

UNL — unlisten

MTA — my talk address

TALK 11 — addresses device at address eleven to talk

LISTEN 30 — addresses device at address thirty to listen

DATA — releases the bus for the data transfer (Series 300)

If the HP 3577A is unaddressed as the talker by the bus controller during a plot, the plotting process can be resumed if the HP 3577A is readdressed to talk and was NOT addressed to listen (with a byte transmitted) in the interim. It is the responsibility of the bus controller to transmit its UNTALK command so that the handshake in progress is completed and data is not lost. Actions that will terminate a PLOT are: addressing the HP 3577A to LISTEN (and sending a data byte), sending a Universal Clear, sending a Selective Device Clear, or an invalid handshake.

If the plot is aborted via the HP-IB, the plotter pen is left in the carriage at its most recent position. If the plot is aborted from the front panel, the pen is returned to its stall and the carriage moved to the P1 position, allowing full view of the plot on plotters that roll the paper in and out for one axis of movement.

PEN SPEED. The bus code PNM (pen speed fast) allows the plotter to run at its maximum (default) velocity. This speed is dependent on the plotter used. The bus code PNS (pen speed slow) causes the plotter pen velocity to be ten centimeters per second.

HP-IB Only Commands

Function	HP-IB code
Settling Time Entry	STE
Dump register A	DRA
Dump register B	DRB
Dump register R	DRR
Dump register D1	DD1
Dump register D2	DD2
Dump register D3	DD3
Dump register D4	DD4
Dump trace 1	DT1
Dump trace 2	DT2
Dump marker 1	DM1
Dump marker 2	DM2
Dump marker 1 position	MP1
Dump marker 2 position	MP2
Dump state (learn mode out)	LMO
Dump status	DMS
Dump average number	DAN
Dump key or knob	DKY
Dump characters	DCH
Dump Instrument ID	ID?
Load register A	LRA
Load register B	LRB
Load register R	LRR
Load register D1	LD1
Load register D2	LD2
Load register D3	LD3
Load register D4	LD4
Load state (learn mode in)	LMI
Graticule Off	GR0
Graticule On	GR1
Characters off	CH0

Function	HP-IB code
Characters on	CH1
Annotation off	ANO
Annotation on	AN1
Annotation Clear	ANC
Menu off	MNO
Menu on	MN1
Menu clear	MNC
ASCII data format	FM1
64 bit IEEE data format	FM2
32 bit HP 3577B binary	FM3
Bus diagnostics mode off	BDO
Bus diagnostics on, fast	BD1
Bus diagnostics on, slow	BD2
Enter Menu (user defined)	ENM
Enter Annotation	ENA
Enter Graphics	ENG
Clear Keyboard Buffer	CKB
Take Measurement	TKM
Set SRQ Mask (entry)	SQM
Error Reporting mode 0	ER0
Error Reporting mode 1	ER1
Error Reporting mode 2	ER2
Error Reporting mode 3	ER3
Send SRQ	SRQ

* Use not required. The only function of this code is to display a menu (if bus diagnostics are on).

The following two example programs demonstrate methods used to recognize the end of a plot process. Either of two bits in the Status Byte are used to trigger SRQ; BO (End Of Transfer) or B4 (Ready).

```

100 !
110 ! Controller responds to plot completion by polling the bus
120 ! CONTROL lines (SRQ=1024) pulled by the instrument's EOT
130 ! bit.
140 !
150     Adrs=711                ! HP 3577A address
160     Plotter=705            ! Plotter address
170     Done_bit=1             ! End of Transfer bit (BO) = 1
180 !
190     OUTPUT Adrs; "SQM" ;Done_bit ! Unmask EOT bit
200 !
210     REPEAT
220         X= SPOLL(Adrs)        ! SPOLL to clear previous EOT bit
230     UNTIL NOT BINAND(X,Done_bit)
240 !
250 ! Next, start the plot.
260 !
270     SEND 7;UNL MTA LISTEN Adrs MOD 100 DATA "PLA" LISTEN Plotter MOD 100
TALK Adrs MOD 100 DATA
280 !
290     DISP "WAITING FOR PLOT COMPLETION"
300     LOOP
310         STATUS 7,7;X          ! Read bus control and data lines
320         EXIT IF BINAND(X, 1024) ! Check for SRQ asserted
330     END LOOP
340 !
350     Plot_done:DISP "PLOT IS COMPLETE."
360     BEEP
370     X= SPOLL(Adrs)          ! Clear SRQ
380     OUTPUT Adrs; "SQM 0"    ! Reset mask to default
390 !
400     END

```

Remote Operation
Eus Messages

```
100 !  
110 ! Controller responds to plot completion using interrupts  
120 ! and the instrument's 'Ready' bit  
130 !  
140     Adrs=711                ! HP 3577A address  
150     Plotter=705            ! plotter address  
160     Done_bit=16           ! 'Ready'=16  
170 !  
180     OUTPUT Adrs; "SQM" ;Done_bit    ! Unmask Ready bit  
190 !  
200     OUTPUT Adrs; "PLA"            ! Get ready to plot. Plot  
210 !                                ! won't start until the HP 3577A  
220 !                                ! is addressed to talk  
230     REPEAT  
240         X= SPOLL(Adrs)            ! SPOLL to get rid of previous Ready  
250     UNTIL NOT BINAND(X,Donebit)  
260 !  
270 ! Next, enable the SRQ interrupt and start the plot.  
280 !  
290     ENABLE INTR 7;2                ! Allow Service Request to interrupt  
300     ON INTR 7 GOTO Plot_done        ! Turn interrupt 'ON'  
310     SEND 7;UNL MTA LISTEN Plotter MOD 100 TALK Adrs MOD 100 DATA ! Start  
plotting  
320 !  
330 !  
340     DISP "WAITING FOR PLOT COMPLETION"  
350     LOOP  
360 !  
370 ! Wait indefinitely for plot completion  
380 !  
390     END LOOP  
400 !  
410     Plot_done:DISP "PLOT IS COMPLETE."  
420     BEEP  
430     X=SPOLL(Adrs)                ! Clear the interrupt condition  
440 !  
450     OUTPUT Adrs; "SQM 0"          ! Resets mask to default condition  
460 !  
470     END
```

SETTLING TIME ENTRY (STE). Settling time may be entered over the HP-IB. Each bandwidth has a settling time associated with it. When a new bandwidth is selected its associated settling time will be active. These new values for settling time are not saved with instrument state and will be cleared by a PRESET or turning off power. The default values for settling time are shown in the following table:

Res BW = 1 kHz	22 ms
Res BW = 100 Hz	55 ms
Res BW = 10 Hz	370 ms
Res BW = 1 Hz	3.707 s

To enter a new value for the settling time parameter, select the resolution bandwidth before entering the new settling time. Settling time values may range from one millisecond to 16.383 seconds. For zero settling time, turn settling time off (SEO). The current value of the settling time parameter will appear in the data entry block if bus diagnostics mode one is used as follows:

Example: OUTPUT 711; "BW3;BD1;STE 3 SEC;"

DUMP/LOAD REGISTER. The receiver input registers R, A, and B, and the storage registers D1, D2, D3, and D4 contain twice as many numbers as there are points in the active sweep resolution. Each point on the trace is derived from a register bin containing a complex number (represented by two real numbers). In the default sweep resolution of 401 points per sweep there will be 401 complex numbers. The HP 3577A will dump 401 real and 401 imaginary numbers in the form real (bin one), imaginary (bin one), real (bin two), imaginary (bin two),... The same methods apply for the "number of steps" sweep resolution used in amplitude sweeps. Register I/O may use any of the three data formats FM1, FM2, or FM3. The example that follows shows how register data may be dumped to the computer/controller and loaded into the HP 3577A in each of the three data formats.

Remote Operation
Bus Messages

Example:

```
10  !
20  !  Dump and Load Registers using all 3 data transfer formats
30  !
40  REAL Real_array1(0:801),Real_array2(0:101)
50  INTEGER Integer_array(0:3,0:400)           ! array of 401 x 4 elements
60  ASSIGN @Na TO 711;FORMAT ON                 ! Na = Network Analyzer
70  OUTPUT @Na; "IPR;SM2;TKM;"                 ! TKM = take measurement
75  !
80  ! *****
85  !
90  !  FM1 = the ASCII data format
100 !  Next, Dump Register R using FM1
110 !
120 OUTPUT @Na; "FM1;DRR;"                     ! DRR = Dump Register R
130 ENTER @Na;Real_array1(*)
140 !
150 ! Real_array1 now contains the real and imaginary parts of
160 ! 401 complex numbers. Next, load the data into storage
170 ! register D1.
180 !
190 OUTPUT @ Na; "LD1;",Real_array1(*)         ! LD1 = Load Register D1
200 !
210 ! Register D1 now contains the data held in Real_array1
220 !
230 OUTPUT @Na; "TR2;DF7;ID1;"                ! Display register D1
240 PAUSE
245 !
250 ! *****
255 !
260 ! FM2 = 64 bit floating point binary (HP Series 200
270 ! computer real number) data format. Next, dump register
280 ! A using FM2. Note the use of reduced sweep resolution.
290 !
300 OUTPUT @Na; "RS1;TKM;FM2;DRA;"            ! Changing sweep res
310                                           ! clears registers, so new
320                                           ! TKM is required
330 !
340 !  Enter the leading bytes (#I) into an unused string
350 !
360 ENTER @Na USING "#,2A" ;Junk$
370 !
380 !  Enter the register data in data format FM2:
390 !
400 ASSIGN @Na;FORMAT OFF                       ! FORMAT must be OFF to
410 ENTER @Na;Real_array2(*)                   ! use data format FM2
420 ASSIGN @Na;FORMAT ON
430 !
440 ! Real_array2 now contains the real and imaginary parts of
```

```

450 ! 51 complex numbers. Load this data into register D2:
460 !
470 OUTPUT @ Na;"LD2; #I;" ; ! Last ";" prevents CR/LF
480 ASSIGN @Na;FORMAT OFF ! Binary data must be
490 OUTPUT @Na;Real_array2(*) ! preceded by "#I"
500 ASSIGN @Na;FORMAT ON
510 !
520 ! Register D2 now contains the data from Real_array2
530 !
540 OUTPUT @Na; "TR2;ID2;ASL;" ! Display data in D2
550 PAUSE
555 !
560 ! *****
565 !
570 ! FM3 = 32 bit floating point binary used by the HP 3577A
580 ! internal processor. There are 4 bytes per real number in
590 ! data format 3. Next, take a measurement and store to D1:
600 !
610 OUTPUT @Na; "RS4;TR1;IBR;TKM;SD1;ASL;"
620 !
630 ! Now Dump D1 in data format FM3:
640 !
650 OUTPUT @Na; "FM3;DD;"
660 !
670 ! Enter the leading bytes (" #I") into an unused string
680 ! then enter the data.
690 !
700 ENTER @Na USING "#,2A" ;Junk$
710 ENTER @Na USING "%,W" ; Integer_array(*) ! 401 x 2x 4 bytes
720 !
730 ! Integer_array now contains the real and imaginary parts
740 ! If 401 complex numbers, each part filling a pair of
750 ! Series 200 Integers. Load this data into register D2:
760 !
770 OUTPUT @ Na; "LDI; #I;" ; ! Binary data must be preceded by
780 OUTPUT @ Na USING "#,W" ;Integer_array ! "#I"
790 !
800 ! Register D1 now contains the data from Integer_array
810 !
820 OUTPUT @Na; "TR2;ID1;DF5;ASL;" ! Display D1 as phase (DF5)
830 !
840 END

```

DUMP TRACE. Traces may be dumped but not loaded. A trace is made up of real numbers as defined under the INPUT and DISPLAY FUNCTION keys and will have the same number of data points as defined in the current sweep resolution. This data is dumped using any of the three data formats with the following units:

Display Function	Absolute Units	Relative Units
	(e.g., INPUT = R)	(e.g., INPUT = B/R)
Log Mag	dBV	dB
Lin Mag	Volts	Units
Phase	Degrees	Degrees
Phase	Volts	Units
Delay	Seconds	Seconds
Real,Imag	Volts	Units

Phase trace data will be offset by the active Phase Reference Level. Delay data will be meaningless in some of the beginning and end bins due to the nature of the measurement. The number of bins affected will depend on the aperture and sweep resolution. When the HP 3577A dumps a delay trace, it will output large negative numbers in those bins whose data is thus affected. The example that follows shows how a trace may be dumped to the computer/controller.

Example:

```

10  !
20  ! Dump Trace example demonstrating use of all three
30  ! data transfer formats.
40  !
50  REAL Real_array1(0:400),Real_array2(0:50)
60  INTEGER Integer_array(0:1,0:400)           ! array of 401 x 2 elements
70  ASSIGN @Na TO 711;FORMAT ON                 ! Na = Network Analyzer
80  OUTPUT @Na;IPR;SM2;TKM;"                   ! TKM = take measurement
85  !
90  ! *****
95  !
100 ! FM1 = the ASCII data format.
110 ! Next, dump trace one
120 !
130 OUTPUT @ Na; "FM1;DT1;"                     ! DT1 = dump trace one
140 ENTER @Na;Real_array1(*)
150 PAUSE
160 !
170 ! Real  array1 now contains 401 real numbers from trace one
180 !
190 ! *****
200 !
210 ! FM2 = 64 bit floating point binary (HP 9000 Series 300
220 ! computer real number) data format. Next, dump trace
230 ! two using FM2 Note the use of reduced sweep res.
240 !

```

```

250  OUTPUT @Na; "RS1;TKM;FM2;DT2;"           ! RS1 = 51 pts/span
260  !
270  ! Enter the leading bytes (" #I") into array elements 0 & 1
280  !
290  ENTER @Na USING "#,2(B)" ;Real_array2(0),Real_array2(1)
300  !
310  ! Prepare for a Series 300 internal real number format
320  ! data transfer and perform the entry.
330  !
340  ASSIGN @Na;FORMAT OFF                   ! FORMAT must be OFF
350  ENTER @ Na;Real_array2(*)              ! to use data format FM2
360  ASSIGN @Na;FORMAT ON                   ! Note that array elements
370  PAUSE
380  !
400  !
410  ! *****
420  !
430  ! FM3 = 32 bit floating point binary used by the HP 3577A
440  ! internal processor. There are 4 bytes per real number
450  ! data format 3. Next, take a measurement and dump trace 1
460  !
470  OUTPUT @Na; "RS4;TKM;FM3;DT1;"
480  !
490  ! Enter the #I as before, then the data.
500  !
510  ENTER @Na USING "#,2A" ;Junk$
520  ENTER @Na USING "%,W" ;Integer_array(*)
530  !
540  ! Integer_array now contains 401 real numbers from trace
550  ! one; each real number (32 bits) filling a pair of Series
560  ! 200 Integers (16 bits).
570  !
580  END

```

Dump Marker, (DM1 & DM2) Except for the polar display function, this is Y-axis information for one bin. The units will match those of the trace dumps shown in the table on page 3-39. If the display function is two, numbers will be output when a marker is dumped. These two numbers will be real and imaginary or magnitude and phase, respectively, depending on units selected for the marker. Any of the three data formats FM1, FM2, or FM3 may be used. The example that follows shows how a marker may be dumped and displayed.

Example: Non-polar display function

```
10      OUTPUT 711; "IPR;TKM;FM1;DM1;"           ! DM1 = Dump Marker one
20      ENTER 711;Marker_amp
30      DISP "Magnitude =" ;Marker_amp
40      END
```

Example: Polar display function

```
10      OUTPUT 711; "IPR;DF4;TKM;FM1;DM1;"       ! DF4 = polar
20      ENTER 711;Marker_amp,Marker_phase
30      DISP "Magnitude =" ;Marker_amp
40      DISP "Phase =" ;Marker_phase
50      END
```

Marker Position (MP1 & MP2) dumps X-axis information for the appropriate trace marker. Any of the three data formats FM1, FM2, or FM3 may be used. The information units are:

LIN SWP	Frequency
LOC Swp	Frequency
ALT SWP	Frequency
AMP SWP	Source amplitude
CW	Frequency

Example:

```
10  OUTPUT 711; "IPR;TEM;MP1;"
20  ENTER 711;Mkr_freq
30  DISP "Marker frequency = ";Mkr_freq," Hz"
40  END
```

Note



If the frequency span is 0 Hz and the sweep time is less than 1000 seconds, the marker position is in units of time.

Dump and Load Instrument State.

LMO (learn mode out) dumps the instrument state out in binary to be stored by the computer. 1100 bytes will always be dumped including the first two bytes which are always #I. #I is used to indicate that binary data is to follow.

LMI (learn mode in) loads instrument state in binary. It is used to configure the HP 3577A to a specific instrument state. This state should be configured on the HP 3577A and dumped to the controller using LMO. Data dumped with LMO should not be changed outside the HP 3577A. It is not possible to configure the instrument state with a computer. LMI can be used to speed up reconfiguration if a large status change is necessary between tests.

It is recommended that the entire 1100 bytes (including the #I) be kept together after the dump as the same information needs to be returned to the HP 3577A when the LMI is used. The example that follows shows how to dump instrument state to a computer/controller and load instrument state back to the HP 3577A.

Remote Operation
Bus Messages

Example:

```
10  !
20  ! 'LMO', Learn Mode Out (dump instrument state)
30  ! 'LMI', Learn Mode In (load instrument state)
40  !
50  INTEGER Integer array(0:549)           ! Array of 550 16 bit words
60  ASSIGN @Na TO 711;FORMAT ON
70  !
80  ! 1100 bytes will be dumped, 2 bytes per element of
90  ! Integer array. Next, configure state and dump it.
100 !
110 OUTPUT @Na: "IPR;TR2;DF5;FRA 1 MHZ;SAM 15 DBM;ST3;LMO;"
120 ENTER @Na USING "%,W" ';Integer_array(*)
130 PAUSE
140 !
150 ! Integer array now contains 1100 bytes of instrument state
160 ! data. This data may be reloaded as follows:
170 !
180 OUTPUT @Na; "IPR;LMI;"
190 OUTPUT @ Na USING "#,W" ;Integer_array(*)
200 !
210 END
```

Dump Status (DMS) This command dumps the Status Byte and two more bytes of instrument status information plus a screen message (the Serial Poll dumps only the Status Byte). In the following table, B7 is the most significant bit and B0 is the least significant bit. All data is in the ASCII format.

DUMP STATUS (DMS) This command dumps the Status Byte and two more bytes of instrument status information plus a screen message (the Serial Poll dumps only the Status Byte). In the following table, B7 is the most significant bit and B0 is the least significant bit. All data is in the ASCII format.

BYTE 1 -The STATUS BYTE

- B7 — Not used
- B6 — RQS (require service)
- B5 — Error bit
- B4 — Ready for HP-IB command
- B3 — Key pressed
- B2 — Measurement complete
- B1 — Data available
- B0 — Data transfer complete

BYTE 2

- B7 — Power on
- B6 — Source tripped
- B5 — Reference unlocked
- B4 — No external reference
- B3 — Input A overload
- B2 — Input B overload
- B1 — Input R overload
- B0 — Input tripped

BYTE 3

- B7 — Settling
- B6 — Waiting for trigger (TRG)
- B5 — Waiting for external trigger or line sync
- B4 — Sweeping
- B3 — End of sweep has occurred
- B2 — Not used
- B1 — Not used
- B0 — Not used

ASCII STRING

A 26-character string containing an error, warning, or general information screen message. The error reporting mode selected will determine the level of message (none, error only, warning and error, or all) that will appear here. Refer to MASKING THE STATUS BYTE for more on error reporting modes, and to Appendix D for a complete listing of these messages.

Bits 0, 1, 2, 3, 5, and 6 of byte two will cause error messages when they become set. If the error bit is unmasked and more than one of these conditions exist, the first to occur will be the only message dumped. If the error bit is masked, DMS will dump the most recent message. The following example program was run immediately after having preset the HP 3577A and pressed a numeric key in the DATA ENTRY section:

Example:

```
10 DIM A$(100)
20 OUTPUT 711; "DMS"
30 ENTER 711;A$
40 DISP "Response to DMS command is" ;A$;"'"
50 END
```

Response to DMS command is

```
' 16, 0, 16, ENTRY UNDEFINED'
```

Dumping status will clear the error string to all blanks. It also clears the Power on, RQS, and (if no permanent hardware errors remain set) the error bit. Its effect on the Status Byte is the same as a serial poll.

DUMP AVERAGE NUMBER (DAN) dumps the number of sweeps or samples taken since averaging was turned on. This number is not the user selection, N. The ASCII equivalent of the average number is returned terminated by <CR/LF> and <EOI>. The data format for DAN is *always* ASCII. The maximum value returned is 9999.

Example:

```
10 OUTPUT 711;"IPR; AV5;"
20 WAIT 5
30 OUTPUT 711;"DAN;"
40 ENTER 711;Avg_no
50 DISP Avg_no
60 GOTO 20
70 END
```

! AV5 = averaging on (N = 64)

CLEAR KEYBOARD BUFFER & DUMP KEY (CKB & DKY) These allow the controller to clear the keyboard buffer (which will hold as many as ten keypresses) and monitor key presses and/or knob rotation. Note that an SRQ may be generated by front panel keys (see STATUS BYTE).

CKB clears the key buffer of key presses and the knob counter to zero. The key buffer holds a maximum of six key presses. The knob counter contains the first count, other than zero, taken by the counter since the last CKB command.

DKY dumps two numbers in ASCII format. The first number corresponds to a front panel hardkey and will range from 0 to 51 inclusive. The following table shows the keys and their corresponding number. If there has been no key pressed since the last CKB command, a - 1 will be returned. The second number is the knob counter which contains a number between - 15 and +15; negative numbers indicate counter-clockwise rotation and positive numbers indicate clockwise rotation. Zero indicates no rotation. The following example shows how the CKB and the DKY commands are used. Also, refer to the example for ENTER MENU and ENTER ANNOTATION.

Example:

```

10  OUTPUT 711;"CKB;"
20  OUTPUT 711;"DKY,"
30  ENTER 711;Key, Knob                ! Enter two numbers
40  IF Key= -1 AND Knob=0 THEN 20
50  DISP "Key=" ;Key;" and Knob = ";Knob
60  OUTPUT 711;"CKB;"
70  GOTO 20
80  END

```

DKY Command Correlation between key pressed and number returned.

Number	Key Name	Number	Key Name
0	zero	27	TRACE 1
1	one	28	TRACE 2
2	two	29	FREQ
3	three	30	AMPTD
4	four	31	TRIG MODE
5	five	32	SWEEP TYPE
6	six	33	Swp MODE
7	seven	34	Swp TIME
8	eight	35	DEFINE MATH
9	nine	36	STORE DATA
10	decimal	37	DISPLAY FCTN
11	minus	38	INPUT
12	backspace	39	SCALE
13	softkey 1 (top)	40	MKR
14	softkey 2	41	MEASR CAL
15	softkey 3	42	(not used)
16	softkey 4	43	SAVE
17	softkey 5	44	RECALL
18	softkey 6	45	SPCL FCTN
19	softkey 7	46	RES BW
20	softkey 8	47	AVG
21	TRIG/RESET	48	ATTEN
22	ENTRY OFF	49	LENGTH
23	LOCAL	50	PLOT
24	MARKER/ENTRY KEY	51	MKR →
25	INCREMENT		
26	DECREMENT		

DUMP CHARACTERS (DCH) Dumps the alphanumeric characters on the screen to determine values of certain parameters. Only information presently on the screen is returned on the bus. As soon as the instrument is addressed to talk the following ASCII information will be returned if the display is NOT in polar format:

1. Reference level for trace 1
2. Amplitude level for trace 1
3. Reference level for trace 2
4. Amplitude level for trace 2
5. Marker frequency for trace 1
6. Marker amplitude for trace 1
7. Marker frequency for trace 2
8. Marker amplitude for trace 2
9. Start frequency for trace 1
10. Stop frequency for trace 1
11. Start frequency for trace 2
12. Stop frequency for trace 2
13. Source amplitude (if not in alternate sweep)
14. Delay aperture (if DSPLY FCTN is DELAY) for the active trace
15. Entry block information (if bus diagnostics are enabled)

If the display format is POLAR, then the following ASCII information is returned:

1. Full scale level
2. Phase reference
3. Reference position
4. <null>
5. Marker frequency
6. Marker amplitude
7. Marker phase
8. <null>
9. Start frequency for trace 1
10. Stop frequency for trace 1
11. Start frequency for trace 2
12. Stop frequency for trace 2
13. Source amplitude (if not in alternate sweep)
14. <null>
15. Entry block information

Each field will be separated by a comma; the last field will be delimited by a carriage return/linefeed. If the field is not defined currently on the CRT, an empty field will be returned.

Remote Operation
Bus Messages

Example

```
10  !
20  ! 'DCH', Dump Characters program
30  !
40  DIM Bfr$(1:15)[40],U$(300),E$(26)
50  Adrs=711
60  ASSIGN @Adrs TO 711
70  !
80  ! —POLAR DISPLAY FUNCTION
90  !
100 OUTPUT @Adrs; "IPR;ST1;TR1;DF4;TKM;DMS;"
110 ENTER @Adrs;X,Y,Z,E$           ! Status read to make sure all commands
120                                     ! have been processed & sweep is done
130 !
140 OUTPUT @Adrs; "ASL;"           ! Auto scale the screen display
150 WAIT.1                          ! Allow time to update picture
160 !
170 GOSUB Get_characters
180 !
190 PRINT "Full scale: " ;Bfr$(1)
200 PRINT "Phase Reference: " ;Bfr$(2)
210 PRINT "Reference position: " ;Bfr$(3)
220 PRINT
230 PRINT "Marker frequency: " ;Bfr$(5)
240 PRINT "Marker amplitude: " ;Bfr$(6)
250 PRINT "Marker phase: " ;Bfr$(7)
260 PRINT
270 PRINT "Start frequency: " ;Bfr$(9)
280 PRINT "Stop frequency: " ;Bfr$(10)
290 PRINT "Source amplitude: " ;Bfr$(13)
300 STOP
310 !
320 Get_characters: !
330 OUTPUT @Adrs; "DCH;"
340 ENTER @Adrs;U$
350 FOR I=1 TO 15
360 IF POS(U$,",") THEN
370 Bfr$(I)= U$[1,POS(U$,",")-1]
380 U$= U$[POS(U$,",")+1]
390 ELSE
400 Bfr$(I)=U$
410 END IF
420 NEXT I
430 RETURN
440 !
450 END
```

Result:

Full scale: FULL SCALE 2.5000
Phase reference: PHASE REF 0.0 deg.
Reference position: REF POSN 0.0 deg.

Marker frequency: MARKER 100 050 000.000 Hz
Marker amplitude: MAG(S21) 646.58E-3
Marker phase: PHASE(S21) - 45.208 deg.

Start frequency: START 100 000.000 Hz
Stop frequency: STOP 200 000 000.000 Hz
Source amplitude: AMPTD 15.0 dBm

DUMP PRODUCT IDENTIFICATION (ID?) The HP 3577A responds with the following ASCII character string:

HP 3577A, TESTSET (or <NULL>) < Software revision >

The "TESTSET" string is present if the HP 35677A or HP 35677B S-Parameter Test Sets are connected to the HP 3577A.

BUS DIAGNOSTIC MODES There are three bus diagnostic modes. They are:

1. BD0 = Bus Diagnostics Off, used for best programming speed.
2. BD1 = Bus Diagnostics On, Fast; menus appear, bus codes appear on screen for three seconds after an error is detected.
3. BD2 = Bus Diagnostics On, Slow; menus appear, bus codes appear and are decoded at the rate of one per second.

BD1 and BD2 are useful for debugging programs written to control the HP 3577A. When on, this mode will sequence through all menus and update the display as if the HP 3577A were being operated from the front panel.

DATA FORMATS. The HP 3577A offers three data formats used to transfer certain types of data on the bus. The data types that make use of all three formats are trace data, register data, marker data, and marker position.

FM1 is the ASCII data format. The ASCII floating point format will always transfer fifteen characters in the form - 12.3456789E +03 for each number (i.e., leading spaces or zeros are not suppressed). In FM1 data dumps, the HP 3577A outputs ASCII data points separated by commas and carriage return line feed (CR/LF) indicates the end of record. When transferring data, the complete set of data is referred to as a record. A record is composed of data and an end of record terminator. When loading data the HP 3577A accepts commas, CR and LF as delimiters between data points. No end of record symbol is required; the instrument will respond to EOI. No more than one delimiter is allowed between numbers; CR/LF is considered a single delimiter. Spaces between and within numbers will be ignored.

Remote Operation
Bus Messages

FM2 is the 64 bit floating point binary specified by IEEE draft standard P754. This is the same data format used by the HP 9000 Series 300 computers. This format appears as follows:

SEEEEEEEEEEMFFF FFFFFFFFFFFFFFFF FFFFFFFFFFFFFFFF FFFFFFFFFFFFFFFFL

where:	M is the most significant bit of the fractional part
	F is an intermediate fractional bit
	L is the least significant fractional bit
	S is the sign bit of the fractional part
	E is the exponent part
and:	M is a "1" The exponent is offset by 127 (i.e. 127=0). This format represents 1.fff... All ones for f's represents ~ 2.0 (i.e., normalized to 2).

FM3 is the 32 bit floating point binary used by the HP 3577A fast processor. This format appears as follows:

MFFFFFFFFFFFFFFF SFFFFFLEEEEEEEEE

where:	M is the most significant bit of the fractional part
	F is an intermediate fractional bit
	L is the least significant fractional bit
	S is the sign of the fractional part
	E is the exponent part
and:	M should always be a "1" The exponent is offset by 128 (i.e., 128=0). This format represents .1ffff... All ones represents ~ 1.0 (i.e., normalized to 1).

In either of the binary data formats the header #I must precede a binary load so that the HP 3577A can recognize the bytes following the header as binary data.

ABORTING A DUMP OR LOAD. A dump or load will be aborted by any one of the following events:

1. End (EOI) sent by talker (FM2 or FM3 load only)
2. Sending non-numeric data (ASCII loads only)
3. Device Clear
4. Pressing the LOCAL front panel key
5. Addressing the HP 3577A to Listen and sending one or more bytes (dumps only).

Note that an Interface Clear (IFC) does not abort a dump or load over the bus. For unconditional control of the bus, it is recommended that Device Clear followed by Interface Clear be issued at the beginning of your program. The BASIC commands that correspond to these are CLEAR 7 and ABORT 7, respectively.

LENGTH OF RECORD The length of the data record (number of points transferred) will depend on the sweep type currently active. This is true for both register data and trace data. Note that in trace dumps of delay, the aperture/2 first and last bins will be undefined; the HP 3577A will output a large negative number in an attempt to protect the user from bad data. Examples of record length:

CW: 1
LIN: Sweep Resolution
LOG: 401
ALT: 401
AMP: Number of steps/sweep plus 1

END OF INFORMATION The bus management line EOI (end or identify) will be pulled by the HP 3577A on the last byte of any data dump whether it is a binary or ASCII dump. Once the HP 3577A has pulled its EOI line it will not transmit any more data until receiving another message. When using ENG (enter graphics) to load graphics commands, <EOI> must be pulled on the handshake of the last byte. Using BASIC on HP computers, such as the HP 9000 Series 300, pulling the EOI line is done by putting; END at the end of the data string as shown in the following example:

Example:
10 OUTPUT 711;"ENG #1";
20 OUTPUT 711 USING "#,W" ;Cmnd_array(*) ;END

Remote Operation
Bus Messages

ENTER MENU (ENM) allows the user to label the eight softkeys. This feature may be used with commands that read the keyboard. It does not allow the user to redefine the key label corresponding to a HP 3577A softkey function. The user defined menu shares the same display memory with system menus. It is recommended that the bus diagnostic mode be kept off to avoid overwriting menus.

To label the softkeys use the following sequence:

ENM	Enter menu bus mnemonic.
"	Opening quote indicates that text follows.
1-3	The softkey number on which to display the message. If the first character is not a number, 1 is assumed.
text	Up to 16 characters of ASCII text. If the text is 8 characters or less a single line key-label will appear centered on the key. If the text is 9 to 16 characters the text will be divided into 2 lines with 8 characters on the first line and the remainder on the second line; the 2 lines will be centered on the key. A carriage return character is not acceptable and will be translated to a left arrow. Double quote marks (") may be included as characters by sending a pair of double quotes ("") to the HP 3577A. Note that the computer may require four quote marks be entered to get two in its program line (resulting in one on the HP 3577A screen).
"	Closing quote mark.
<delim>	This delimiter may be the characters; <CR/LF> space or the act of pulling <EOI> on the handshake of the last byte transferred.

Whenever the instrument returns to LOCAL mode and the front panel is enabled, the user defined menu will be overwritten with the present system definition of the softkeys. For an example program using ENM, refer to Enter Annotation. Additional functions to control the menu display memory:

Menu off	MNO
Menu on	MN1
Menu clear	MNC

ENTER ANNOTATION (ENA) This command allows the user to provide text strings and to specify on which of twelve lines it will appear. These lines are located in the graticule area; four near the top, four in the middle, and four near the bottom. They are located such that there is no interference with the message block in which errors and warnings are displayed.

The format to be used is as follows:

ENA	Enter annotation bus mnemonic.
"	Opening quote indicates that text follows.
1-12	The display line number on which the annotation is to be displayed. If the first character is not numeric, line 1 will be assumed.
text	Up to 40 characters of ASCII text. The carriage return character code is unacceptable and will be translated to a left arrow if used.
"	Closing quote marks.
<delim>	This delimiter may be the characters: <CR/LF> space or the act of pulling <EOI> on the handshake of the last byte transferred.

Remote Operation
Bus Messages

Example:

```
10  !
20  ! 'ENA', ' ENM' Use of Enter Annotation and Enter Menu
30  ! 'CKB', 'DKY' Use of Clear Keyboard and Dump Key
40  !
50      Adrs=711
60      ASSIGN @Adrs TO Adrs
70      OUTPUT @Adrs;"ANC;MNC;"                ! Clear annotation and menu
80  !
90  ! Next, define the annotation and menu
100 !
110     OUTPUT @Adrs; "ENA;""2                Special Test""
120     OUTPUT @Adrs; "ENA;""4                Select appropriate MENU KEY.""
130 !
140     OUTPUT @Adrs; "ENM;""1 CONTINUE""
150     OUTPUT @Adrs; "ENM;""4                TEST FAILED""
160     OUTPUT @Adrs; "ENM;""8 ABORT""
170 !
180 ! Note that a pair of double quotes must be used to send
190 ! one double quote mark (") at execution time. To get a
200 ! double quote to appear in the HP 3577A screen annotation,
210 ! 4 double quotes (""") must be written into the program.
220 !
230     LOOP
240         OUTPUT @Adrs; "MN1;AN1;"           ! Turn annotation & menu on
250         OUTPUT @Adrs; "CKB;"             ! Clear the keyboard buffer
260         LOOP
270             OUTPUT @Adrs; "DKY;"        ! Read the keyboard
280             ENTER @Adrs;Key,Knob
290             EXIT IF Key=13 OR Key=16 OR Key=20
300             IF Key < > -1 THEN BEEP      ! -1 = no key pressed
310         END LOOP
320     OUTPUT @Adrs; "MNO;"                 ! Turn menu off
330     SELECT Key
340     CASE 13
350         OUTPUT @Adrs; "ENA;""5           CONTINUE key pressed""
360     CASE 16
370         OUTPUT @Adrs; "ENA;""5           TEST FAILED key pressed""
380     CASE 20
390         OUTPUT @Adrs; "ENA;""5           ABORT key pressed""
400     END SELECT
410 !
420     WAIT 2
430     OUTPUT @Adrs; "ENA;""5""           ! Clears the message
440     OUTPUT @Adrs; "MN1;"                 ! Turn the menu back on
450 !
460     END LOOP
470 !
480     END
```

ENTER GRAPHICS (ENG) The graphics mode allows the user to place alphanumeric information anywhere on the screen in different sizes, intensities and rotational positions, as well as draw vectors. Although this offers more flexibility than ENA, knowledge of the Digital Display Module command set is required. This information uses the same display memory as the ENA function, therefore the two functions cannot be used together.

The format to be used is as follows:

ENG	Enter Graphics bus mnemonic.
#l	Indicates binary words to follow.
<0-923>	Starting address within annotation block where Digital Display commands are to be placed. Sent as a 16 bit binary number, MSB first.
Digital Display commands	Sent as 16 bit binary words, MSB first. The commands for the Digital Display are binary commands. When the ENG command is used the HP 3577A will pass these commands to the display section. Appendix B is a quick reference programming guide for the Digital Display. The JUMP command is not allowed. The carriage return character will be translated into a left arrow. Memory capacity is 924 commands.
<EOI>	End Or Identify will be sent with the last data byte to indicate the end of the sequence.

Remote Operation
Bus Messages

Example:

```
1000 !
1010 !   Use of Enter Graphics
1020 !
1030   COM INTEGER Cmnd_array(0:20),Array_indx,Disp_adrs,Array_ length,@ Adrs
1040   INTEGER Plotx,Movey,Ploty,Set_cmd,Text(1:5),Es
1050   INTEGER I,J,K
1060   Array_length = 20
1070   Array_indx=1
1080   Disp_adrs=0
1090   Adrs=711
1100   ASSIGN @Adrs TO Adrs
1110 !
1120   OUTPUT @Adrs; "IPR;ANC;"           ! Clear state and annotation
1130   OUTPUT @Adrs; "AN1;"             ! Turn the display ON
1140   OUTPUT @Adrs; "TR1;DF0;GR0;CH0;"
1150 !
1160 !   Define the annotation commands
1170 !
1180 !       The PLOT command for the display:  000y pddd dddd dddd
1190 !
1200 !           Where:  y = 0 for x definition; 1 for y definition
1210 !                   p = 0 for 'pen up'; 1 for 'pen down'
1220 !                   d = location in range 0 to 2047
1230 !
1240   Plotx=0
1250   Ploty=6144
1260   Movey=4096
1270 !
1280 !   The SET CONDITIONS command for the display:
1290 !
1300 !       011i i--I I0-w w---
1310 !
1320 !           Where: i defines the line intensity
1330 !                   00 - blank
1340 !                   01 - dim
1350 !                   10 - half bright
1360 !                   11 - full bright
1370 !           l defines line type
1380 !                   00 - solid line
1390 !                   01 - intensified end points
1400 !                   10 - long dashes
1410 !                   11 - short dashes
1420 !           w defines writing speed
1430 !                   00 - 0.20 inches per microsecond
1440 !                   01 - 0.15" " "
1450 !                   10 - 0.10" " "
1460 !                   11 -0.05" " "
1470 !
```

```

1480 Set_cmnd =30744          ! full bright, solid line, & .05 in/us
1490 !
1500 !   The TEXT command:  010s srre cccc cccc
1510 !
1520 !       Where: s defines character size
1530 !           00 - 1.0X
1540 !           01 - 1.5X
1550 !           10 - 2.0X
1560 !           11 - 2.5X
1570 !       r defines rotation
1580 !           00 - 0 degrees
1590 !           01 - 90 degrees
1600 !           10 - 180 degrees
1610 !           11 - 270 degrees
1620 !       e - establish size of character
1630 !           0 - Use previous size and rotation
1640 !           1 - Use new size and rotation
1650 !       c - character code (see table in appendix)
1660 !
1670 Text(1) = 16384          ! size is 1X and rotation is 0 deg
1680 Text(2) = 18944          ! size is 1.5X and rotation is 90 deg
1690 Text(3) = 21504          ! size is 2.0X and rotation is 180 deg
1700 Text(4)= 24064          ! size is 2.5X and rotation is -90 deg
1710 Text(5)=22528          ! size is 2.5X and rotation is 0 deg
1720 Es=256                  ! "establish size and rotation" flag
1730 !
1740 !   Plot a square on the HP 3577A screen:
1750 !
1760 Sqr: DATA 100,100      ! x,y coordinate for lower left corner
1770     DATA 100, 1000     ! upper left
1780     DATA 1000, 1000    ! upper right
1790     DATA 1000, 100    ! lower right
1800 !
1810 ! Since the display units are not equal (i.e., Y-axis
1820 ! units are 3/4 the size of the X-axis units on the
1830 ! display), the Y-axis units should be divided by .75
1840 ! to get a true square.
1850 !
1860 Y_axis_scale= .75
1870 READ X0,Y0              ! read the first point
1880 CALL Add_cmnd(Set_cmnd) ! initialize SET CONDITION
1890 CALL Add_cmnd(X0 + Plotx) ! move to starting point
1900 CALL Add_cmnd(Y0/Y_axis_scale + Movey)
1910 FOR I=1 TO 3
1920     READ X,Y
1930     CALL Add_cmnd(X+ Plotx)
1940     CALL Add_cmnd(Y/Y_axis_scale+ Ploty)
1950 NEXT I

```

Remote Operation
Bus Messages

```
1960 CALL Add_cmnd(X+ Plotx)
1970 CALL Add_cmnd(Y0/Y_axis_scale + Ploty)           ! plot to starting pt
1980 !
1990 ! Now display the following message in the four different
2000 ! sizes and rotations
2010 !
2020 Message$= "HP3577"
2030 !
2040 CALL Add_cmnd(550 + Plotx)                       ! define the start of characters
2050 CALL Add_cmnd(500+ Movey)
2060 FOR I=1 TO 4
2070     CALL Add_cmnd(Text(I) + Es + NUM(Message$)) ! 1st character
2080                                           ! w/ Es asserted
2090     FOR J = 2 TO LEN(Message$)
2100         CALL Add_cmnd(Text(I)+ NUM(Message${J}))
2110     NEXT J
2120 NEXT I
2130 !
2140 IF Array_indx < 1 THEN CALL Transfer_cmnd        ! transfer if necessary
2150 !
2160 Array_indx=1                                     ! reinitialize buffer
2170 Cmnd_array(0)=100                               ! use address 100 for this buffer
2180 CALL Add_cmnd(1500+ Plotx)                       ! define starting position for
2190 CALL Add_cmnd(1500 + Movey)                     ! loop
2200 CALL Add_cmnd(Text(5)+ Es +1)                   ! character "1" is HP logo
2210 OUTPUT @Adrs; "ENG #I" ;
2220 OUTPUT @Adrs USING "W" ;Cmnd_array(*) ;END
2230 !
2240                                     ! The following steps will update the
2250                                     ! two commands which define the starting
2260                                     ! location of the HP logo. It demonstrates
2270                                     ! changing selected commands "on the fly."
2280 LOOP
2290     Cmnd_array(1)= INT(1500*RND)+ Plotx           ! Update new starting
2300     Cmnd_array(2) = INT(1900* RN D) + Movey      ! position for logo.
2310     OUTPUT @Adrs; "ENG #I" ;                     ! Update new x,y
2320     OUTPUT @Adrs USING "#,W,W,W" ;Cmnd_array(0) Cmnd_array(1),
        Cmnd_array(2);END
2330 WAIT .1
2340 END LOOP
2350 !
2360 STOP
2370 !
2380 END
2390 !
2400 ! The following subroutine adds Digital Display commands to
2410 ! Cmnd_array until it contains 20 (Array_length) elements.
2420 !
2430 SUB Add_Cmnd(INTEGER Value)
```

```

2440     COM INTEGER Cmnd_array(*),Array_indx,X,Array_length, @ Adrs
2450     Cmnd_array(Array_indx)=Value
2460     Array_indx= Array_indx+1
2470     IF Array_indx> Array_length THEN
2480         CALL Transfer_cmnd
2490         Array_indx=1
2500     END IF
2510 SUBEND
2520 !
2530 ! Send Cmnd array to HP 3577A
2540 !
2550 SUB Transfer_cmnd
2560 COM INTEGER Cmnd_array(*), Array_indx,Disp_adrs,Array_length,@Adrs
2570 Cmnd_array(0)= Disp_adrs
2580 OUTPUT @Adrs; "ENG #I" ;                ! Send ENG and #I
2590 OUTPUT @Adrs USING "#,W" ;Cmnd array(*);END ! send array
2600 FOR K = 0 TO Array_length                ! Clear out Cmnd_array
2610 Cmnd_array(K)= 0
2620 NEXT K
2630 Disp_adrs = Disp_adrs + Array_indx-1    ! Redefine display
2640                                           ! memory address for
2650 SUBEND                                    ! next transfer.

```

ANNOTATION OFF (AN0) Turns off the Annotation/Graphics modes by disabling the display memory.

ANNOTATION ON (AN1) Enables the commands in display memory.

ANNOTATION CLEAR (ANC) Clear display memory back to NOP instructions.

Additional functions to control the screen are:

Graticule On	GR1
Graticule Off	GR0
Characters On	CH1
Characters Off	CH0 (screen messages will not be turned off)

The character fields controlled by the CH commands are:

1. Information at the bottom of the screen.
2. The REF and /DIV messages and their values
3. The entry block
4. The marker data

The following screen features have their own on/off commands:

1. Trace data (the traces themselves; **TR1 DF0** and **TR2 DF0**)
2. Trace reference lines (**TR1 RL0** and **TR2 RL0**)
3. Annotation
4. Menu

TAKE MEASUREMENT (TKM) When this command is received the HP 3577A settles and takes a measurement before processing the next bus command. TKM (followed by a dump command) guarantees that the measurement will be completed before data transfer begins. For faster measurements RST and TRG may be used as shown previously.

Instrument Preset (default) Parameter Values

The HP 3577A responds to the instrument preset (IPR) command configuring its parameters as defined in the following table:

FUNCTION	PRESET CONDITION	
	Without test set	With test set
TRACE 1	Active	same
TRACE 2	Off	same
DISPLAY FUNCTION	Log magnitude	same
INPUT		
def. (both traces)	R	S ₂₁ (B/R, test set FWD)
user defined input	F3	same
SCALE (log mag)		
Reference level	0.0 dBm	0.0 dB
/DIV	10.0 dB	same
Reference position	100 %	same
Reference line	On	same
SCALE (linear mag)		
Reference level	0.0 Volts	0.0 units
/DIV	100 mV	100E-3 units
Reference position	0.0 %	same
Reference line	On	same
SCALE (phase)		
Reference level	0.0°	0.0°
/DIV	45 degrees	same
Reference position	50 %	same
Reference line	On	same
Phase slope (Trc 1&2)	On, 0.0%/span	same
SCALE (polar)		
Full scale	1.0 Volts	1.0 units
Phase reference	0 0°	same
Reference position	0.0°	same
Reference line	On	same
Phase slope (Trc 1&2)	On, 0.0%/span	same
SCALE (real & imaginary)		
Reference level	0.0 Volts	0.0 units
/DIV	200 mV	200E-3 units
Reference position	50 %	same
Reference line	On	same
Phase slope (Trc 1&2)	On, 0.0%/span	same

Remote Operation
Bus Messages

Function	Preset Condition	
	Without test set	With test set
SCALE (delay)		
Reference level	0.0 s	same
/DIV	100 ns	same
Reference position	50 %	same
Reference line	On	same
Phase slope (Trc 1&2)	On, 0.0%/span	same
MARKER (Both traces)		
Marker	On	same
Position	Bin 200	same
Offset (Mag, freq swp)	Off, 13.01 dBm	Off, 0.0 dB
Freq Offset (X-axis)	0.0 Hz	0.0 Hz
Offset (Mag, amptd swp) Off	13.01 dBm	Off, 0.0 dB
Amptd Offset (X-axis)	13.0 dBm	13.0 dBm
Target	10.01 dBm	- 3.0 dB
STORE		
User def equation	R	same
DEFINE MATH		
K1 real	1	same
K1 imaginary	0	same
K2 real	50	same
K2 imaginary	0	same
K3 real	75	same
K3 imaginary	0	same
F1	$(B/R)/(K1 - B/R)$	same
F2	A/R	same
F3	$(K1 + F2)/(K1 - F2)$	same
F4	$K2 * F3$	same
F5	$K3 * F3$	same
SWEEP TYPE		
Sweep direction	Linear (freq)	same
Sweep mode	Up (left to right)	same
SWEEP MODE		
Sweep time (linear swp)	Continuous	same
(amplitude swp)	1000 s	same
(manual swp mode or CW)	0.050 s/step	same
	0.050 s/step	same
FREQUENCY		
Start freq (linear swp)	0.000 Hz	100 kHz
Start freq (log sweep)	50.000 Hz	100 kHz
Stop frequency	200 MHz	same
Center frequency	100 MHz	100.05 MHz
Frequency span	200 MHz	199.9 MHz
Center freq step size	1.0 MHz	same

Function	Preset Condition	
	Without test set	With test set
FREQUENCY (continued)		
Freq sweep resolution	401 points/span	same
AMPLITUDE		
Source amplitude	- 10.0 dBm	+ 15.0 dBm
Amplitude step size	1.0 dBm	same
Start amplitude	- 40.0 dBm	same
Stop amplitude	0.0 dBm	+ 15.0 dBm
Steps/sweep	100	same
TRIGGER MODE	Free run	same
RESOLUTION BANDWIDTH	1 kHz	same
Setting time for:		
Res BW = 1 kHz	22 ms	same
Res BW = 100 Hz	55 ms	same
Res BW = 10 Hz	370 ms	same
Res BW = 1 Hz	3.707 s	same
AVERAGING	Off	same
INPUT ATTENUATION		
Input R	20 dB	same
Input A	20 dB	same
Input B	20 dB	same
INPUT IMPEDANCE		
Input R	50Ω	same
Input A	50Ω	same
Input B	50Ω	same
INPUT LENGTH		
Input R	On, 0.0 meters	On, 1.3 meters
Input A	On, 0.0 meters	same
Input B	On, 0.0 meters	same
Step size	1.0 meter	same

The Status Byte

The Status Byte is an 8 bit word that the HP 3577A will dump on the HP-IB when it is serially polled. The state of each bit indicates the status of an internal HP 3577A function.

BASIC example:
Var= SPOLL(711)

HPL example :
rds (711)→S

Status Byte Bit Numbers

B7 B6 B5 B4 B3 B2 B1 B0

B7:	Not used
B6:	REQUIRE SERVICE, RQS. Set when the HP 3577A pulls the SRQ line. Cleared along with the SRQ line when a serial poll is performed.
B5:	ERROR This bit reflects the logical OR of all error conditions in the instrument. An SRQ is generated on the rising edge of any of these error conditions. The error conditions include all HP-IB errors and all hardware error conditions. The hardware errors include input overloads, input tripped, source tripped, and reference unlocked. The error bit is cleared when the hardware error conditions have cleared and a serial poll is performed, if the error bit is unmasked. If the bit is masked it will clear whenever the error conditions clear (i.e., it won't stay set until the poll occurs). It is also cleared by a dump status command (DMS) when the user receives the error information (if all hardware error bits are clear). Four levels of masking are provided for the user to select what type of programming errors will be reported by the error bit. See MASKING THE STATUS BYTE.
B4:	READY (for HP-IB commands) Set when the HP-IB input buffer is completely empty, all commands have been completely processed, and (if the last command was RST) settling is complete. If a command is issued during a sweep, the ready bit will clear until command processing is complete.
B3:	KEY PRESSED/SRQ If unmasked, this bit will be set when a key is pressed or the knob is turned. Also, this bit is set when the HP 3577A receives the "SRQ" command on the bus. The set condition is cleared by a serial poll.
B2:	MEASUREMENT COMPLETE Set when sweep completes Cleared by the start of a new sweep
B1:	DATA AVAILABLE Instrument will output data when addressed to talk. Cleared by the handshake of the last byte.
B0:	DATA TRANSFER COMPLETE Set after the HP 3577A handshakes the last data byte in a dump. Primarily designed for plotting. Cleared by a serial poll if it is unmasked, or upon B1 being set.

Any status bit that is unmasked will cause an SRQ (and set RQS) when the condition it represents is true. As long as the condition is true, the bit will stay set. The bit will reset when the condition has cleared and the instrument is serially polled.

Any status bit that is masked will follow the condition it represents, resetting without a serial poll whenever the condition clears.

Masking The Status Byte

A service request will be generated when any unmasked bit in the status byte becomes set. The SRQ mask may be loaded by sending SQM followed by the mask byte in ASCII. The mask byte definition is as follows:

SQM		0	1
B7	(not used)		
B6	(RQS)		not maskable
B5	(Error)	mask B5	enable B5 SRQ
B4	(Ready)	mask B4	enable B4 SRQ
B3	(Key/SRQ)	mask B3	enable B3 SRQ
B2	(MEAS DONE)	mask B2	enable B2 SRQ
B1	(DATA AVAIL)	mask B1	enable B1 SRQ
B0	(XFER DONE)	mask B0	enable B0 SRQ

In the default instrument state SQM = 0 (all bits masked). Pressing INSTR PRESET or sending IPR over the bus will set SQM = 0.

The user may choose the level of screen message that sets the SRQ line (and which level of message appears with DMS) by selecting one of the following four modes:

ER0	Nothing will be reported
ER1	Only errors will be reported
ER2	Errors and warnings will be reported
ER3	Errors warnings and messages will be reported

The default selection is ER1. If the error bit is unmasked, the following conditions will pull SRQ regardless of the error reporting mode selected:

- Input(s) tripped
- Input(s) overloaded
- Reference unlocked
- Source tripped

"How To Go Fast" Example Programs

These two example programs are written for the HP 9000 Series 300 computers. The first program demonstrates the fastest measurement technique for any display function except group delay (with the appropriate changes in line 300 to change from DF7 (default) to DF_, and line 610 to print the correct units after the value of the data dumped). The second program is an example demonstrating the fastest way to make group delay measurements.

Example:

```
10  ! This program demonstrates the fastest possible single-
20  ! point (CW) measurements that the HP 3577A is capable of.
30  !
40  ASSIGN @Na TO 711
50  ASSIGN @ Na_nofmt TO 711;FORMAT OFF
60  Meas_complete =4
70  Pass=0
80  CLEAR @Na
90  OUTPUT @ Na; "IPR;"          ! Initialize the bus
                                ! Preset the instrument
100 !
110 ! Turn characters and bus diagnostics off to improve speed
120 !
130 OUTPUT @Na;"CHO;BD0;""
140 !
150 ! Set the data transfer format to 64 bit binary (IEEE)
160 !
170 OUTPUT @Na;"FM2;"
180 !
190 ! Select single sweep mode to improve speed
200 !
210 OUTPUT @Na;"SM2;"
220 !
230 ! Select CW sweep type (fastest method for making single
240 ! point measurements)
250 !
260 OUTPUT @Na;"ST5;"
270 !
280 ! Set up measurement conditions
290 !
300 OUTPUT @ Na; "SAM -6 DBM;TR1; BW4;UDI B/R;TSF;"
310 Freq = RND*2.00E + 8          ! Select a random frequency
320 OUTPUT @Na;"SFR";Freq;"HZ;"
330 OUTPUT @Na; "TKM;"          ! 1st meas is done with TKM
340 LOOP
350   Starttime= TIMEDATE
360   Oldfreq = Freq
370   Freq = RND*2.00E + 8      ! Select next random frequency
380   !
390   ! Next, go to the new frequency and begin settling,
```

```

400      ! then dump the marker data from the last measurement.
410      !
420      OUTPUT @ Na;"SFR";Freq;"HZ;RST;DM1;TRG;"
430      !
440      ! Note that TRG (trigger the new measurement) will not
450      ! occur until settling is complete.
460      !
470      ENTER @Na USING "%,2A" ;Junk$           ! gets "#I" characters
480      ENTER @ Na_nofmt;Y                       ! gets marker data for Oldfreq
490      Start_meas = TIMEDATE
500      !
510      ! Next, wait for the data to be taken. Data analysis
520      ! may be performed here, while waiting.
530      !
540      REPEAT
550          Stat= SPOLL(711)
560      UNTIL BINAND(Stat,Meas_complete)
570      Stoptime = TIMEDATE
580      Measure_time = INT((Stop_time-Start_meas)*1000 +.5
590      Time = INT((Stoptime-Start_time)*1000 +.5
600      DISP "PASS ";Pass;", TOTAL TIME = ";Time;"msec Measurement =
";Measure_time;" msec"
610      PRINT "FREQ:" ;Oldfreq/1.E +6; "MHz, Y: ";Y;" dB"
620      Pass = Pass +1
630  END LOOP
640  END

```

Remote Operation
Bus Messages

Example:

```
10  ! This program demonstrates the fastest possible 5-point
20  ! group delay measurements possible on the HP 3577A.
30  !
40  ! Data can be dumped by moving the marker or dumping the
50  ! trace.
60  !
70  OPTION BASE 0
80  DIM Mkr(5)                ! Array holding the 5 marker values for
90                          ! the filter to be tested
100 DIM Trace(100)          ! Array holding the 100 trace data points.
110 ASSIGN @Na TO 711
120 ASSIGN @Na_nofmt TO 711; FORMAT OFF
130 Ready_bit=16
140 Meas_complete=4
150 Pass=0
160 Answer$="M"
170 INPUT "Dump Trace (T) or Dump Marker (M): ",Answer$
180 IF (Answer$[1,1]="T") OR (Answer$[1,1] = "t") THEN
190     PRINT "Will use Dump Trace"
200     Dump_trace=1
210 ELSE
220     PRINT "Will use Marker Dump"
230     Dump_trace=0
240 END IF
250 Startuptime=TIMEDATE
260 CLEAR @Na
270 OUTPUT @ Na; "IPR;"      ! Preset the instrument
280 !
290 ! Turn off characters and bus diagnostics for greater speed
300 !
310 OUTPUT @Na;"CHO;BDO;"
320 IF Dump_trace THEN
330     OUTPUT @Na; "FM2;"   ! Use 64 bit binary data format
340 ELSE
350     OUTPUT @Na; "FM1;"   ! The marker will be dumped in ASCII
360 END IF
370 !
380 ! Select single, linear sweep and delay (display fctn. 1)
390 !
400     OUTPUT @Na;"SM2;ST1;TR1;DF1;"
410     OUTPUT @Na;"SAM 0 DBM;TR1;BW4;UDI B/R" ! Measurement set up
420     OUTPUT @ Na;"RS2;"   ! Reduced sweep res improves speed.
430                          ! HP 3577A will change its delay
440                          ! aperature to 2% of span and beep.
450 !
460 ! Set up the freq definition for a 10.7 MHz bandpass filter
```

```

470 !
480 OUTPUT @Na; "FRC 10.7 MHZ;FRS 45 KHZ;STM 0.1 SEC;"
490 OUTPUT @ Na; "TKM;ASL;"           ! Sweep and autoscale for onlookers
500 REPEAT                             ! Wait for end of measurement
510     Stat=SPOLL(711)
520 UNTIL BINAND(Stat,Ready_bit)
530 OUTPUT @Na; "TKM;"
540 Starttime=TIMEDATE
550 PRINT "Initialization time: "INT((TIMEDATE-Startuptime)* 1000); "msec"
560 LOOP
570     REPEAT                           ! Wait for end of measurement
580         Stat=SPOLL(711)
590     UNTIL BINAND(Stat,Ready_bit)
600     Swptime=TIMEDATE
610     !
620     ! Now the data is taken and a new filter may be selected
630     ! for testing. This selection may occur while this data
640     ! is being dumped
650     !
660     IF Dump trace THEN
670         !
680         ! Dump the entire trace. Assume that the program
690         ! processes the data during the Donemkr interval that
700         ! currently displays how long this took.
710         !
720         OUTPUT @Na; "DT1;TKM;"           ! dump trace & take new meas
730         ENTER @Na USING "%,2A" ;Junk$    ! Gets the "#I"
740         ENTER @Na_nofmt;Trace(*)        ! Gets the trace data
750         !
760         ! The "Take Measurement" command in line 720 is
770         ! executed as soon as the "Dump Trace" is complete
780         ! (when the computer has entered it; i.e., now).
790         !
800     ELSE
810         ! Send the commands to dump data at 5 marker
820         ! positions. Then enter them one at a time.
830         !
840         OUTPUT @ Na; "MKP 23;DM1;MKP 33;DM1;MKP 50;DM1;MKP 67;
DM1;MKP 77;DM1;TKM;"
850         ENTER @Na;Mkr(1)
860         ENTER @Na;Mkr(2)
870         ENTER @Na;Mkr(3)
880         ENTER @Na;Mkr(4)
890         ENTER @Na;Mkr(5)
900     END IF
910     Donemkr:
920         Stoptime=TIMEDATE
930         Time_to_sweep = INT((Swptime-Starttime)*1000)
940         Time_to_dump = INT((Stoptime-Swptime)*1000)

```

Remote Operation
Bus Messages

```
950      Time_total = INT((Stoptime-Starttime)*1000)
960      DISP "PASS ";Pass;", SWEEP TIME = ";Time_to_sweep;" msec
Dump=";Time_to_dump;" msec TOTAL = ";Time_total;" msec"
970      Pass=Pass+1
980      Starttime=Stoptime
990      END LOOP
995  END
```

Chapter 4

Reference

Reference

This section of the manual is an alphabetical listing of the hardkeys and their menus, the front panel sections and some of the terms used throughout this manual. It is assumed that the operator is an experienced user and is referring to this section for details.

Amplitude

Amplitude is a hardkey in the SOURCE section of the front panel used to display either menu of softkey labels shown below. These softkeys may be used to change the signal level of the source output. The HP 3577A source amplitude range from -49 dBm to $+15$ dBm in $.1$ dBm steps; the default value at power-on is -10 dBm without a test set and $+15$ dBm with a test set.

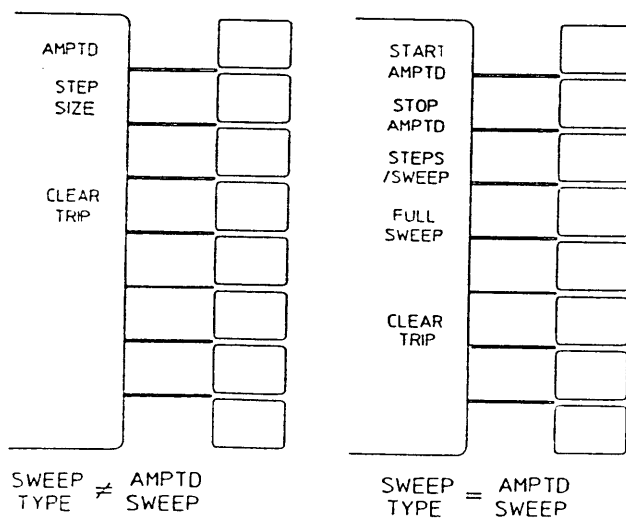
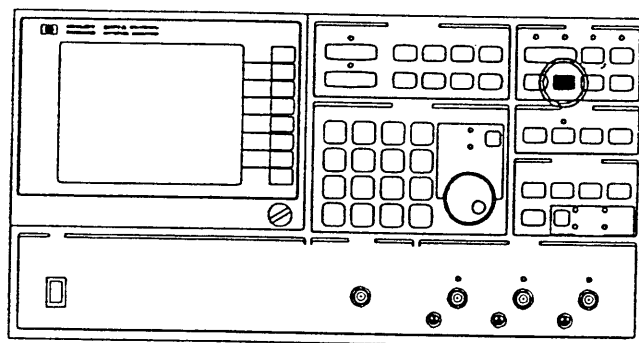

Figure 4-1.

AMPLITUDE is also a softkey in the **AMPLITUDE** menu used to change the value of source amplitude. After power turn-on or **INSTRUMENT PRESET**, this softkey is active. A bright label in the menu indicates softkey selection.

To change the value of **AMPLITUDE**:

1. Press the **AMPTD** hardkey to display the menu
2. Press the **AMPTD** softkey (if label is not bright)
3. Modify the value with the knob or arrow keys

OR

4. Enter a new value with the numeric key pad.
Select units from the menu (press softkey)

When the **SWEEP TYPE** is **ALTERNATE**, each trace may be given separate amplitude values. For more information see **SWEEP TYPE, ALTERNATE SWEEP**.

Step Size is a softkey used to change the value that the arrow keys (in the **DATA ENTRY** section) increase or decrease the output amplitude. **STEP SIZE** is adjustable from .1 dB to 64 dB in .1 dB steps. The default value for **STEP SIZE** is 1.0 dB.

To change the value of **STEP SIZE**:

1. Press the **AMPTD** hardkey to display the menu
2. Press the **STEP SIZE** softkey (if label is not bright)
3. Modify the value with the knob or arrow keys

OR

4. Enter a new value with the numeric key pad
Select units from the menu (press softkey)

CLEAR TRIP (Source) is a softkey in the **AMPTD** menu used to reset the **SOURCE TRIP**. The source is protected against large external signals applied to it by a relay in the output circuit which opens when the voltage is $\geq 4V_{pk}$. If the source **TRIPS**, the user is directed by a screen message to press the **AMPTD** hardkey in the **SOURCE** section of the front panel. This displays the menu containing the softkey label "CLEAR TRIP." Pressing **CLEAR TRIP** resets (closes) the relay in the source output. If the condition causing the trip still exists the source trips again.

START AMPLITUDE is a softkey in the **AMPTD** menu (when the **SWEEP TYPE** is **AMPLITUDE SWEEP**) used to change the value of the sweep parameter **START AMPLITUDE**. The default value for start amplitude is -40dBm . The allowable range is the same as the range of the source output amplitude, -49 dBm to $+15\text{ dBm}$. The value of start amplitude may be larger than the stop amplitude. Units used for data entry of new values for start and stop amplitude may be linear (volts) but the sweep is always logarithmic.

To view the menu shown in figure 4-1:

1. Press the **SWEEP TYPE** hardkey
2. Press the **AMPTD SWEEP** softkey
3. Press the **AMPTD** hardkey

To change the value of **START AMPLITUDE**:

1. Press the **START AMPTD** softkey (if the label is not bright)
2. Modify the value with the knob or arrow keys

OR

3. Enter a new value with the numeric key pad
Select units from the menu (press softkey)

STOP AMPLITUDE is a softkey label in the **AMPTD** menu (when the **SWEEP TYPE** is **AMPLITUDE SWEEP**) used to change the value of the sweep parameter **STOP AMPLITUDE**. The default value for stop amplitude is 0.0 dBm if no test set is connected to the HP 3577A and $+15\text{ dBm}$ with a test set. The allowable range is the same as that of the source output amplitude, -49 dBm to $+15\text{ dBm}$. The value of stop amplitude value may be smaller than the start amplitude.

To change the value of **STOP AMPLITUDE**:

1. Press the **STOP AMPTD** softkey
2. Modify the value with the knob or arrow keys

OR

3. Enter a new value with the numeric key pad
Select units from the menu (press softkey)

STEPS/SWEEP is a softkey used to change the number of amplitude data point measurements taken and plotted on the screen. The value may only be changed by softkey selection, only. When **STEPS/SWEEP** softkey is pressed, a menu appears that contains all possible selections. They are 5, 10, 20, 50, 100, 200, and 400. The default number is 100. A large number of **STEP/SWEEP** makes the trace smooth while a small number lowers the required **SWEEP TIME**.

Attenuation

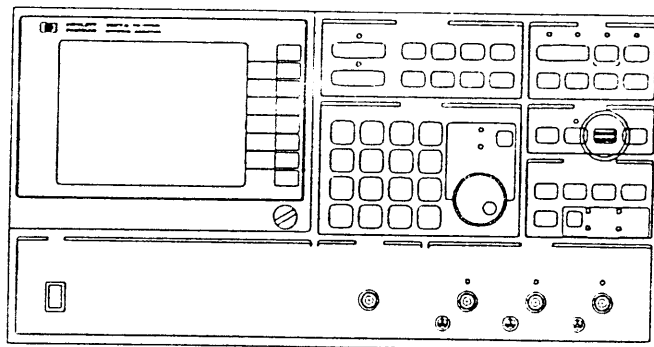

ATTEN R 0dB 20dB		
ATTEN A 0dB 20dB		
ATTEN B 0dB 20dB		
IMPED R 50Ω 1MΩ		
IMPED A 50Ω 1MΩ		
IMPED B 50Ω 1MΩ		
CLEAR TRIP		

Figure 4-2.

Attenuation is a hardkey in the RECEIVER section of the front panel used to display the menu shown above. These softkeys may be used to select the input attenuation and input impedance for each of the three receiver channels. Also, the CLEAR TRIP for the receivers is included in this menu.

Each input channel has two possible input impedances (50Ω or 1 MΩ) and two possible input attenuations (0 dB or 20 dB). When the instrument is PRESET all channels revert to the default values: 50Ω input impedance and 20 dB input attenuation. All of the attenuation and impedance softkeys are the push-push toggle type. Each has two possible states; the bright part of the labels indicate which state is active. These parameters may only be changed by softkey selection.

The two input attenuation values may be thought of as measurement ranges. Normally the HP 3577A is in the high range, with 20 dB of input attenuation. To increase the HP 3577A's ability to measure very small signal levels, change the input attenuation to 0 dB. The following table lists the signal levels at which overload occurs for any combination of input attenuation and impedance:

OVERLOAD SIGNAL LEVELS		
INPUT ATTENUATION	INPUT IMPEDANCE	
	50 Ω	1 M Ω
20 dB	0 dBm	- 13 dBV (224 mV)
0 dB	- 20 dBm	- 33 dBV (22.4 mV)

All front panel connections on the HP 35677A S-PARAMETER TEST SET have a characteristic impedance of 50 Ω . If a 75 Ω characteristic impedance is required use an HP 35677B.

To modify the impedance and attenuation parameters:

1. Press the **ATTEN** hardkey to display the menu
2. Press the softkey of the parameter you wish to change

CLEAR TRIP (RECEIVER) is a softkey used to reset a **RECEIVER TRIP**. A **RECEIVER TRIP** provides input voltage protection by switching the input impedance to 1 M Ω when the signal level is $\geq 1.1V_{pk}$. When any receiver trips the screen message "INPUT TRIPPED: Chan_, Clear trip on ATTEN menu" appears. This change of impedance does not show in the **ATTEN** menu. The menu shows the user's selections and has the **CLEAR TRIP** softkey which should be used to reset the **TRIP** condition. The **CLEAR TRIP** softkey clears any and all inputs that are tripped.

Average

AVERAGE is a hardkey in the **RECEIVER** section of the front panel used to display the menu of softkeys shown in figure 4-3. Selection of any of the numbered softkeys turns on the exponential averaging feature of the HP 3577A. When averaging is on, the LED above the **AVG** hardkey is illuminated. The number selected by the user from the menu is a weighting factor called **N** in the following discussion.

Averaging is useful for removing the effects of noise from a trace. It is best to select a small **N** if you wish to adjust the response of the device under test while sweeping. A small **N** (like 4) shows response changes faster than a large **N**. If you want a very good "final" picture, pick 256 (or other large value for **N**). The larger **N** is, the more noise is reduced. This feature is capable of reducing trace noise as much as 24 dB ($N = 256$). Another way to reduce trace noise when measuring weak signals is to switch out the 20 dB **RECEIVER** attenuators. See **ATTENUATION**.

To use **AVERAGE**, press the hardkey labeled **AVG** in the **RECEIVER** section of the front panel. The list of choices appears in the menu area of the display. If the feature is off the word **OFF** appears bright in the menu. If any other selection is made, the new selection becomes bright and **AVERAGE** is on. The **AVERAGE** weighting factor **N** may only be changed by softkey selection. Averaging does not stop after **N** sweeps.

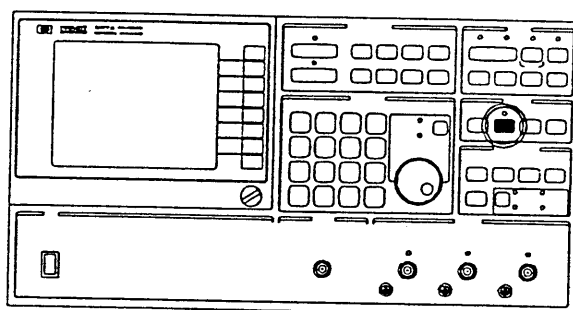

OFF	<input type="checkbox"/>
4	<input type="checkbox"/>
8	<input type="checkbox"/>
16	<input type="checkbox"/>
32	<input type="checkbox"/>
64	<input type="checkbox"/>
128	<input type="checkbox"/>
256	<input type="checkbox"/>

Figure 4-3.

The averaging algorithm is a continuous process that begins when the feature is turned on (N is selected). The number selected by the user (N) is used in the equation below to yield an exponential average.

$$\text{NEXT VALUE} = \frac{1}{N} \times (\text{NEW VALUE}) + \frac{N-1}{N} \times (\text{CURRENT VALUE})$$

If N is 256, the new sweep data is weighted by 1/256 and the current data by 255/256. You can see that each sweep does not change the trace much when N = 256. If N is 4, the new sweep data is weighted by 1/4 and the current data by 3/4; so new data changes the trace faster when N is small.

The HP 3577A stores the trace information in "bins." Each bin contains a measurement value taken at a discrete frequency in the sweep and is as wide as the selected bandwidth. As each new value is taken, the math processor weights (multiplies) it by 1/N, weights the old value by (N-1)/N, adds the two together and stores the result in the same bin in which the old value was stored. Multiple traces are not stored. In this manner, the effect of any single sample diminishes as each average weights its value at some factor less than one and adds it to new incoming data.

The preceding discussion has described how the averaging feature works after N sweeps (samples). Until that time, the averaging algorithm cycles up through lower values of N until it reaches the user's selection. For example, let N = 256. The first value used in the equation for N is 4. After several sweeps a higher value of N is used and the process repeated until 256 is reached. The HP 3577A uses this method because it displays a useable trace faster than if N were large and constant.

Note

After averaging with a large N for a long time (i.e. many sweeps) removing the device under test does not affect the trace noticeably.

The LED above the **AVG** key is on when the HP 3577A is averaging.

Continuous Entry

In the DATA ENTRY section of the front panel there are three ways to enter or modify data: the keypad, the arrow keys, and the knob. CONTINUOUS ENTRY refers to the knob in ENTRY mode.

To use CONTINUOUS ENTRY the active (bright) softkey must be a type that allows data entry. When the key above the knob is pressed the LEDs marked "MARKER" and "ENTRY" toggle. The knob is capable of CONTINUOUS ENTRY when the ENTRY LED is lit. When in MARKER mode the knob moves the markers on the screen. It is recommended that the knob be left in MARKER mode so that data modifications are not made when the knob is accidentally rotated. The ENTRY OFF hardkey also turns off the knob ENTRY mode by removing the menu (and therefore any active softkey) from the screen.

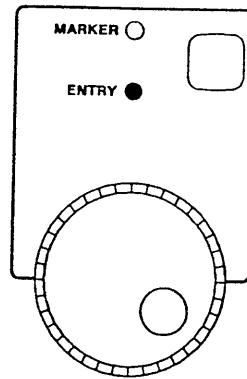

Figure 4-4.

Data Entry

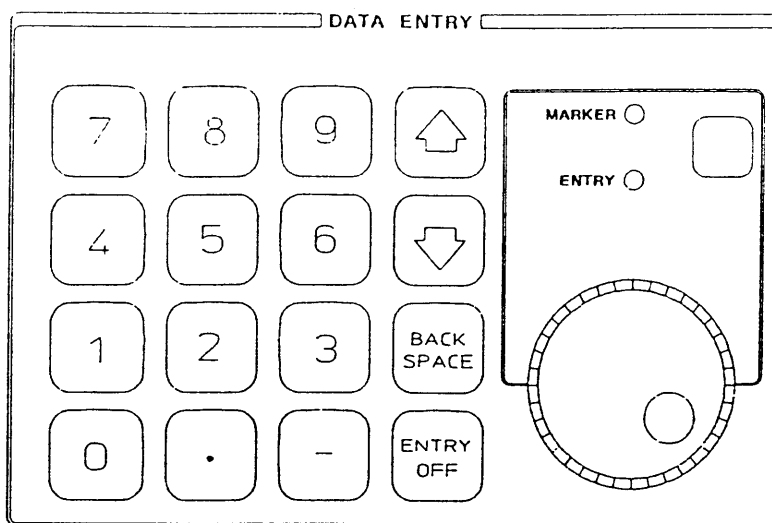

Figure 4-5.

DATA ENTRY is a section of the front panel used for entering or modifying data. It contains a numeric keypad, increment/decrement (arrow) keys, a **BACKSPACE** key, **ENTRY OFF** key and the knob. If new entries are made with the keypad, units must be entered with the softkeys at the right side of the screen before the new entry is complete.

The **BACKSPACE** key is used to correct data entries or trace arithmetic equations. When the backspace key is pressed, the cursor in the entry block (text in the upper-right corner of the screen) backs up one space, erasing that character. If an error is made in the data entry, the HP 3577A displays a screen message, beeps and retains the original entry. The new entry must be backspaced over before new data may be entered. Another alternative is to begin again with the hardkey. This replaces your data in the entry block with the current definition of the parameter.

Entry Off is used to keep the knob from changing an **ENTRY** value or to clear the screen of menus and messages. The graticule and all characters are displayed at low intensity and the trace(s) are bright.

The **KNOB** is used in one of two modes: to move the **MARKER** or for (continuous) **ENTRY** (i.e. data modification). It toggles between these two modes when the key above it is pressed. Two LEDs, marked **MARKER** and **ENTRY**, show which mode the knob is in. When preset, the knob is in the **MARKER** mode. It is good operating practice to keep it in **MARKER** so that accidental rotation of the knob does not modify whatever entry currently appears in the menu. Note: when **MARKER POSITION** (in the MKR menu) is bright, the knob moves the marker in either **MARKER** or **ENTRY** mode (the entry would be **MARKER POSITION**).

Reference
Data Entry

The **INCREMENT/DECREMENT** keys are used to increment (↑) or decrement (↓) data for the selected (bright) softkey if it is an item that allows data entry; you can increment a sweep time but not a sweep type. The message "ENTRY UNDEFINED" appears if you try to modify a softkey for which data entry is not appropriate. If held down for more than 1 second, the up/down keys auto-repeat. The amount of change is determined by the step size of the parameter to be modified and may be a data entry, itself. Refer to the particular parameter in this section for more information on its step size.

Data Register

There are four registers used to STORE trace DATA. They are called D1, D2, D3, and D4. Stored data is in the same form (complex) created by the receivers and stored in trace memory. Therefore, any data register information may be recreated in any of the DISPLAY FUNCTION formats (LOG MAG, PHASE, GROUP DELAY, etc.). Refer to Appendix A for more information on DATA PROCESSING AND STRUCTURE.

The data stored in any of the data registers may be displayed by specifying the data register of interest as an INPUT. Press the **INPUT** hardkey and the softkey labeled DATA REG, then select the data register of interest from the menu. Refer to STORE DATA.

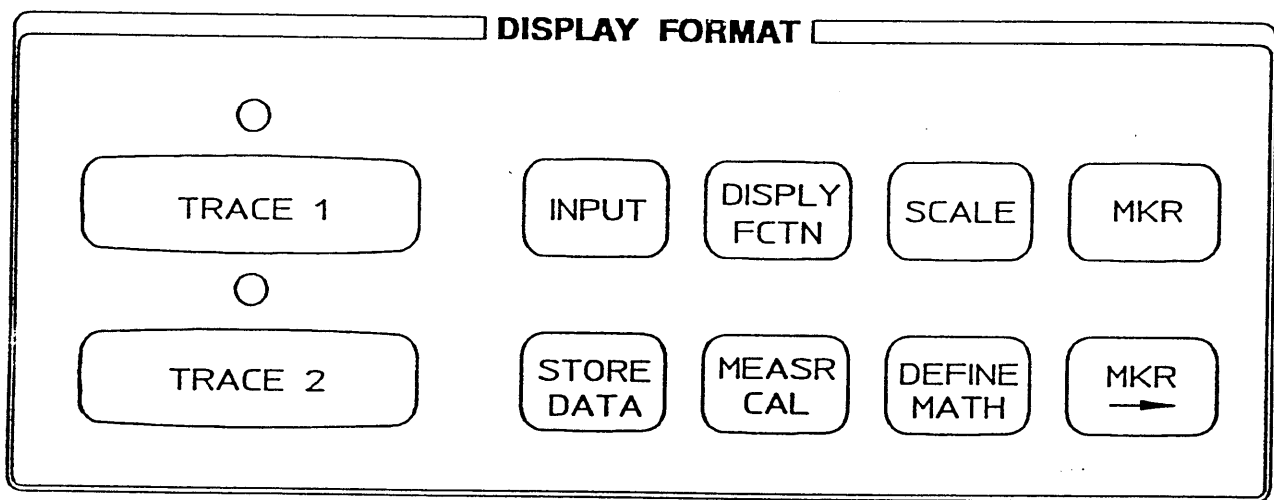

Figure 4-6.

Define Math

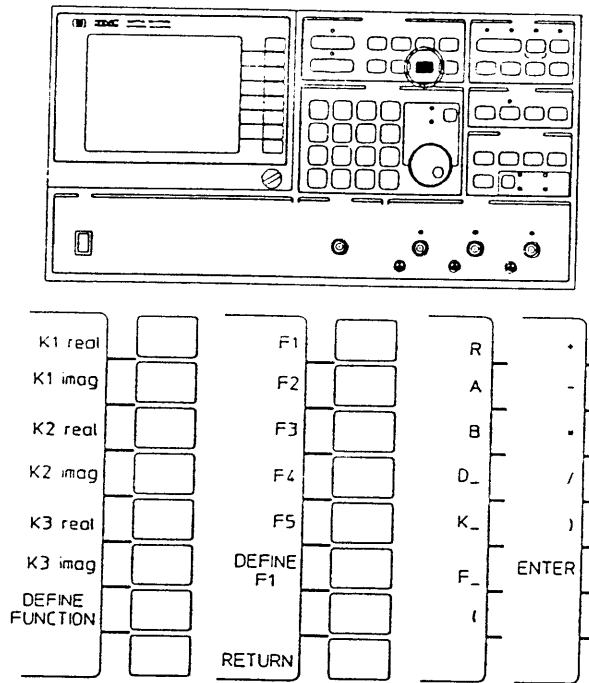

Figure 4-7.

DEFINE MATH is a hardkey in the **DISPLAY FORMAT** section of the front panel used to display the menu shown above. These softkeys may be used to define three complex constants and five functions. Constants and functions may be used as terms in **USER DEFINED INPUTS** or **USER DEFINED STORES**.

The constants are displayed in the menu as soon as the **DEFINE MATH** key is pressed. Each component, real and imaginary, of each constant, K1 through K3, may be defined by pressing the appropriate softkey and making a data entry with the numeric keypad. The entry appears in the entry block on the screen as it is entered. To correct entry errors use the backspace key in the **DATA ENTRY** section.

The functions may be defined by pressing the **DEFINE FUNCTION** softkey. This displays a new menu containing

1. The 5 user definable functions, F1 through F5
2. A command to DEFINE F_
3. RETURN, which displays the previous menu.

Also displayed is an entry message (on the screen) showing the current definition of the bright function. This message changes to show the new entry as it is entered.

One of the $F_{_}$ softkey labels is bright and appears in the DEFINE $F_{_}$ softkey label. Selecting another $F_{_}$ changes the DEFINE $F_{_}$ command. When the DEFINE $F_{_}$ key is pressed the entry block shows the equation being defined and the menu changes to a selection of the first term to be used. This list includes the three input channels (R, A, and B), the four data registers ($D_{_}$), the three constants ($K_{_}$), the other functions (only lower numbered functions may be used to define this function), and parenthesis to be used in constructing the equation.

When a softkey is pressed the menu changes to the list of math functions or (if $K_{_}$, $F_{_}$ or $D_{_}$ was the first selection) a list of numbers to finish describing the term. The menu continues to change as the equation is built and the entry block shows what is being entered. If errors are made they may be erased by backspacing over them. When finished, one of the softkey labels should allow the function to be ENTERed. Character strings may not be longer than 17; if longer strings are necessary you may divide them among as many user defined functions as necessary and then define an **INPUT** equation with them. See MEASUREMENT CALIBRATION for an example. The default constant and function definitions are listed in the following table.

$K1 = 1.0 + 0.0j$	$F1 = (B/R)/(K1 - B/R)$
$K2 = 50 + 0.0j$	$F2 = A/R$
$K3 = 75 + 0.0j$	$F3 = (K1 + F2)/(K1 - F2)$
	$F4 = K2 * F3$
	$F5 = K3 * F3$

When the function is ENTERed there is no change in the trace unless the **INPUT** is a function of the term just defined. This new **USER DEFINED FUNCTION** may now be used in a user defined **INPUT** or **STORE**. The trace arithmetic capabilities of the HP 3577A make complicated error corrections or special conversions easy. See MEASUREMENT CALIBRATION for examples.

Note



Pressing INSTR PRESET or cycling the power switch redefines all user defined functions. Be sure to **SAVE** instrument state if you wish to retain the **USER DEFINED FUNCTIONS**.

Recall Old State may be used to recover the user defined functions as they were defined when power was last turned off or in case of power failure.

Display Format

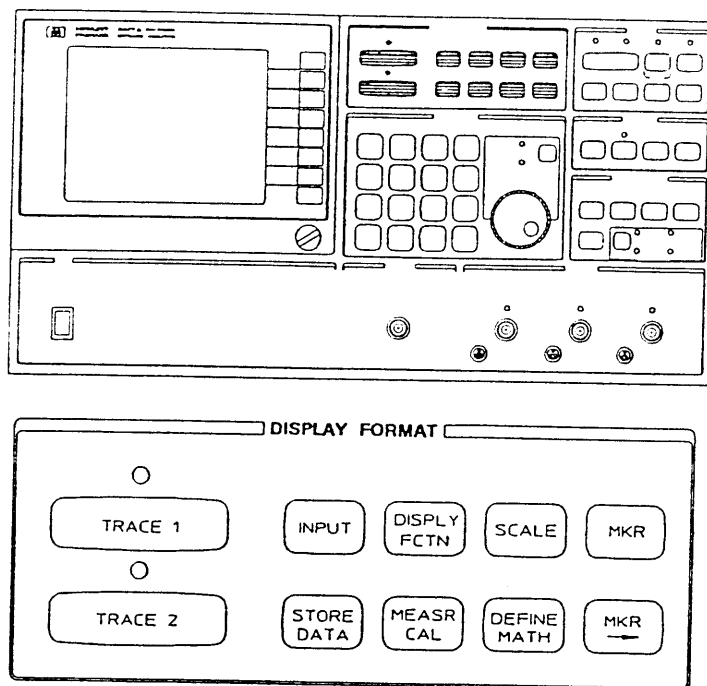
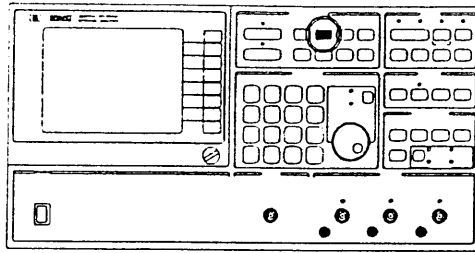

Figure 4-8.

DISPLAY FORMAT is one of five front panel sections. The hardkeys in this section display menus of softkeys used to:

- | | |
|---------------------|--|
| INPUT | Define screen trace in terms of receiver inputs, stored data, user defined constants, and user defined functions |
| DISPLAY FCTN | Define screen trace in terms of how the complex data is interpreted (LOG MAG, PHASE, GROUP DELAY, etc.) |
| SCALE | Define graticule scale (REF LEVEL, /DIV, etc.) |
| MKR | (Marker) read data from the displayed trace |
| MKR → | (Marker goes into) enter data using the position of the mark |
| STORE DATA | Store complex data as defined under the INPUT hardkey |
| MEASR CAL | Normalize or do partial (two term) or full (three term) error correction of one-port measurements |
| DEFINE MATH | Define three constants and five functions |

Display Function



LOG	<input type="checkbox"/>	<input type="checkbox"/>
MAG	<input type="checkbox"/>	<input type="checkbox"/>
LN	<input type="checkbox"/>	<input type="checkbox"/>
MAG	<input type="checkbox"/>	<input type="checkbox"/>
PHASE	<input type="checkbox"/>	<input type="checkbox"/>
PDLAR	<input type="checkbox"/>	<input type="checkbox"/>
REAL	<input type="checkbox"/>	<input type="checkbox"/>
MAG	<input type="checkbox"/>	<input type="checkbox"/>
DELAY	<input type="checkbox"/>	<input type="checkbox"/>
OFF	<input type="checkbox"/>	<input type="checkbox"/>

Figure 4-9.

DISPLAY FUNCTION is a hardkey in the **DISPLAY FORMAT** section of the front panel used to display the menu of softkeys shown above. These softkeys may be used to define the screen trace in terms of how the complex data in trace memory is interpreted. If any of the top 7 entries in the menu are bright, the trace is on. The trace may be turned off with the bottom softkey.

Reference
Display Function

LOG MAGNITUDE is a softkey in the **DISPLAY FUNCTION** menu. Immediately after preset or power-on, **LOG MAG** is the active **DISPLAY FUNCTION**. If not already bright, pressing this softkey defines the y-axis as log magnitude. It does not accept data entry. The default **SCALE** parameters for **LOG MAGNITUDE** are:

REF LEVEL: 0 dBm (without test set)
/DIV: 10 dBm
REF POS: 100%

The **REFERENCE LEVEL** and **/DIVISION** parameters are listed on the screen above the graticule. Reference refers to the dashed line; its value is 0 dBm and its position on the screen is top or 100%. The **REFERENCE POSITION** may be checked by pressing the hardkey **SCALE**, and then the softkey **REF POS**. At this point data may be entered for the reference position.

LINEAR MAGNITUDE is a softkey in the **DISPLAY FUNCTION** menu used to define the y-axis as linear magnitude. It does not accept data entry from the keypad. When **LINEAR MAG** is selected the **SCALE** parameters change to the following:

REF LEVEL: 0.0V (without test set)
/DIV: 100 mV (without test set)
REF POS: 0.0%

PHASE is a softkey used to define the y-axis as phase information. The softkey label **PHASE SLOPE** appears in the **SCALE** menu when **PHASE** is the current display function. Default **SCALE** parameters for **PHASE** are:

REF LEVEL: 0.0 deg
/DIV: 45 deg
REF POS: 50%

To use this feature, select the trace you wish to be a phase trace by pressing either the **TRACE 1** or **TRACE 2** hardkey, press the **DSPLY FCTN** hardkey, and then press the **PHASE** softkey. The selected trace is now phase information.

POLAR is a softkey used to display trace information in a polar format. In the polar format, only one trace is displayed so if both traces are on in a rectangular format when polar is selected, the non-active trace is turned off. The active trace is indicated by the LEDs over the TRACE 1 and TRACE 2 hardkeys.

The polar format changes the menu listings of the SCALE, MKR, and MKR→ hardkeys as shown in figure 4-10.

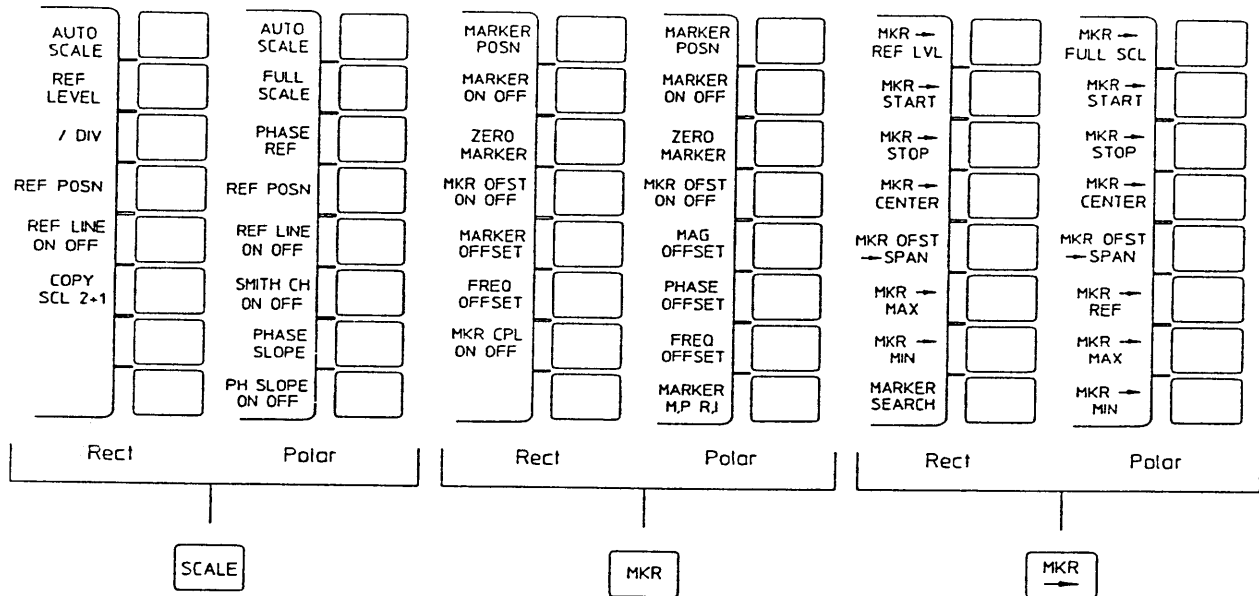

Figure 4-10.

Reference
Display Function

REAL is a softkey used to define the y-axis as real. The unit of measure for the real and imaginary display functions is volts or units. When this display function is selected the HP 3577A displays the real half of the complex data stored in trace memory. See Appendix A on Data Processing and Structure.

IMAGINARY is a softkey used to define the y-axis as imaginary. The unit of measure for the imaginary and real display functions is volts or units. When this display function is selected the HP 3577A displays the imaginary half of the complex data stored in trace memory.

DELAY (GROUP) is a softkey used to select group delay as the display function. When selected, this softkey label changes to **DELAY APERTURE**. **DELAY APERTURE** activates a menu which allows the user to change the delay aperture.

Choosing a display function selects the math used to interpret the data in trace memory as the selected function. The data collected during the sweep does not depend on which function is selected. How the data is collected is determined by the source and receiver settings. See "Data Processing And Structure" in Appendix A.

The **DELAY** display function does not exist in the **DISPLAY FUNCTION** menu if the **SWEEP TYPE** is **LOG SWEEP**, **AMPLITUDE SWEEP**, **CW** or if the sweep mode is **MANUAL**.

Group delay is the derivative of phase with respect to frequency ($d\phi/df$). In the HP 3577A this is approximated by using the function $\Delta\phi/(\Delta f \times 360)$. The user selects the **DELAY APERTURE** (Δf) in % of span (frequency) from a menu. The HP 3577A calculates the change in phase for the specified aperture and divide $\Delta\phi$ by $\Delta f \times 360$.

The point plotted is located between the data points used to calculate it. For example, the group delay for 100 Hz may be calculated by measuring the change in phase between 90 and 110 Hz. Therefore, no data is calculated for the endpoints of the trace. If you had specified a start frequency of 90 Hz, 100 Hz would be the first point with group delay data. This results in a trace that does not extend to the edges of the screen (more noticeable as the delay aperture is made larger).

The unit of measure for group delay is time. The readings are in seconds or fractions of seconds from 0.01 ns to 1000.0 seconds. Larger apertures yield finer resolution of units because τ_g (group delay) = $\Delta\phi$ (with fixed phase resolution) divided by Δf . The larger the aperture (Δf), the smaller τ_g is.

When the display function is group delay (or any phase dependent function) the scale menu includes "PHASE SLOPE." Initially this feature is on and the default value is 0 deg/span.

DELAY APERTURE is a softkey label that is created in the **DISPLAY FUNCTION** menu when **DELAY** is selected. Delay aperture is the frequency span over which the HP 3577A evaluates phase and calculate group delay. This frequency span is in percent-of-span; selections include .5%, 1%, 2%, 4%, 8%, and 16%. The selected aperture appears below the lower-right corner of the graticule in Hertz when the active trace is group delay. See figure 4-11.

To find and/or modify **DELAY APERTURE** press **DSPLY FCTN** and then **DELAY**. The softkey **DELAY** changes to read **DELAY APERTURE** when pressed. Pressing this key displays the list of apertures in the menu area. Large apertures have more of a smoothing effect on the trace than smaller apertures

Delay aperture is somewhat dependent upon sweep resolution (a softkey in the **FREQ** menu). When sweep resolution is 201, the delay aperture cannot be less than 1% of span. The HP 3577A automatically changes aperture from .5% to the larger value when sweep resolution is changed. Aperture is increased to 2% when a sweep resolution of 101 is selected, and is increased again to 4% when sweep resolution becomes 51. See the example for **SWEEP RES** under the **FREQ** hardkey.

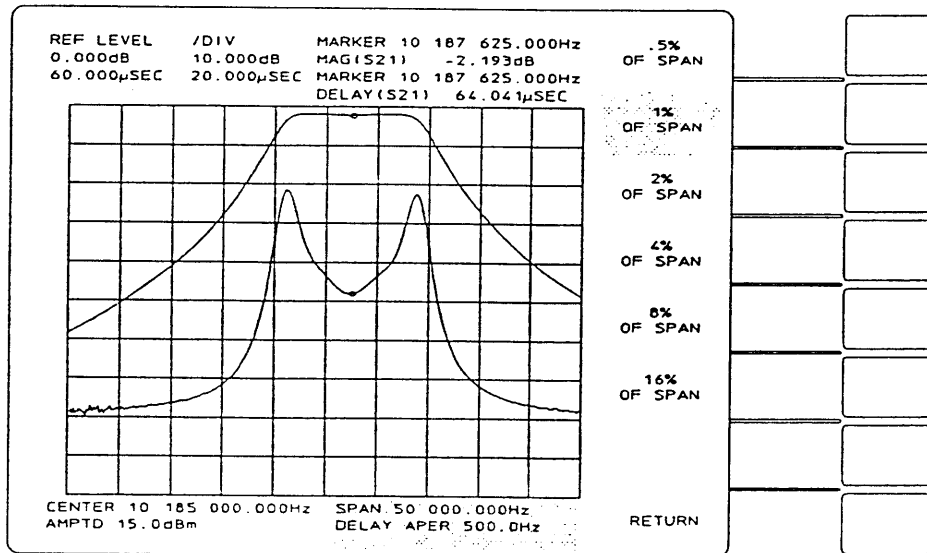

Figure 4-11

Entry Block

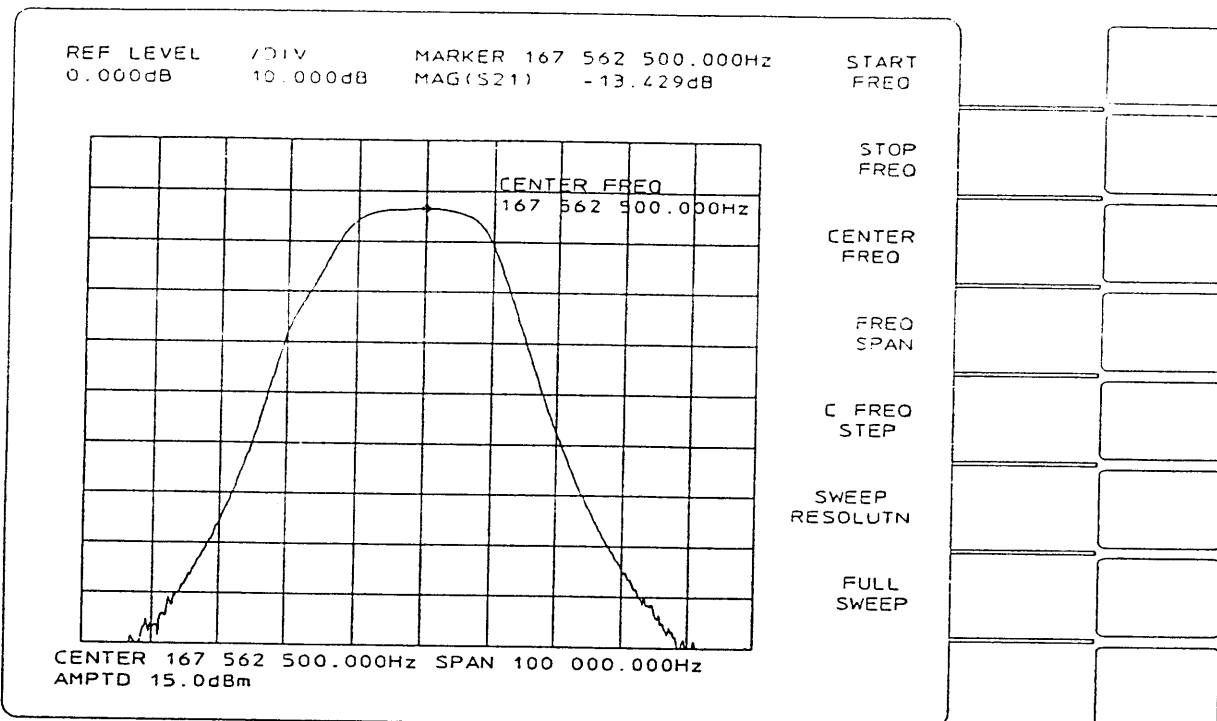

Figure 4-12

The ENTRY BLOCK is a portion of the screen where entry messages appear. These messages show the data entered or modified. Any time a new menu is selected and the active (bright) softkey label is a data entry item, its current value appears in the upper-center portion of the screen. If the selected trace is changed to 2 and trace 2 is off, no message appears.

Example: TRACE 1
Press SCALE hardkey REF LEVEL
 0.000 dBm

External Reference

This input on the rear panel allows the HP 3577A to be connected to an external frequency reference. When a signal is present on this input the EXT REF LED in the upper right hand corner of the front panel lights. The HP 3577A phaselocks to signals from -7 dBm to $+15$ dBm at any frequency, accurate to ± 20 ppm, that is the result of dividing 10 MHz by an integer and is above 100 kHz. If the source connected to the EXTERNAL REFERENCE varies more than this, the HP 3577A switches to its own internal reference. When this occurs, the EXT REF LED extinguishes and the HP 3577A beeps as phaselock is lost during the switch.

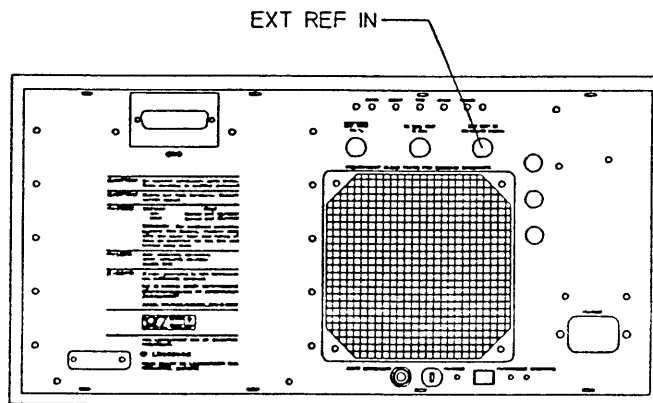
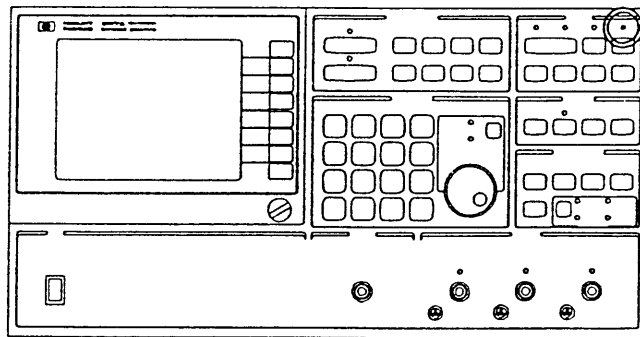

Figure 4-13.

Frequency

FREQUENCY is a hardkey in the **SOURCE** section used to display the menu of softkeys shown above. These softkeys are used to modify the frequency parameters. Immediately after pressing **INSTR PRESET** or cycling power, **START FREQ** is the active (bright) softkey.

The top 5 softkeys in this menu allow data entry. **SWEEP RESOLUTION** calls another menu used to select the number of sampled frequencies or bins that are the data points of the trace. **FULL SWEEP** is an immediate execution command that resets the start frequency and stop frequency to get a full sweep; or you may think of it as resetting the center frequency and the frequency span.

If the **SWEEP TYPE** is **LOG FREQ** the menu consists of the following:

START FREQ
STOP FREQ
FULL SWEEP

If the **SWEEP TYPE** is **CW** or **AMPTD** the menu consists of the following:

FREQ
STEP SIZE

If the **SWEEP TYPE** is **ALTERNATE**, different frequency parameters may be entered for each of the two active traces. See **SWEEP TYPE, ALTERNATE**.

START FREQ is a softkey used to enter data for the sweep start frequency. To enter a new start frequency:

1. Press the **FREQ** hardkey to display the menu
2. Press the **START FREQ** softkey (if label is not bright)
3. Modify the value with the knob or arrow keys
OR
Enter a new value with the numeric key pad
4. Select units from the menu (press a softkey)

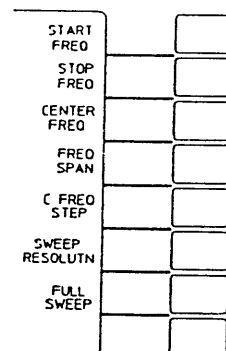
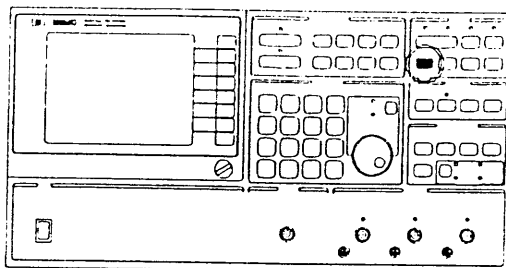

Figure 4-14.

STOP FREQ is a softkey used in the same manner as **START FREQ** for entering data for the sweep stop frequency. The **START** and **STOP FREQ** values appear below the graticule.

CENTER FREQ is a softkey used in the same manner as **START** and **STOP FREQ** for entering data for the sweep center frequency. There is no defined center frequency when the **SWEEP TYPE** is **LOG FREQ**, **CW**, or **AMPTD**. The **START** and **STOP** information below the graticule changes to **CENTER** and **SPAN** when either of the latter two are selected.

FREQ SPAN is a softkey used in the same manner as **START FREQ** for entering data for the frequency span represented by the graticule. There is no frequency span when the **SWEEP TYPE** is **LOG FREQ**, **CW**, or **AMPTD**. If the frequency span is 0 Hz and sweep time is less than 1000 seconds, the marker position reads in units of time.

CENTER FREQ STEP is a softkey used to enter data for the step size taken when the increment/decrement arrows are used to modify the center frequency value. Data entry for this parameter is accomplished in the same manner as for **START FREQ**.

Reference
Frequency

SWEEP RESOLUTION is a softkey used to change the number of sample frequencies measured by the HP 3577A. The default value for sweep resolution is 401 points. These correspond to the bins referred to in Appendix A. Each bin is as wide as the selected resolution bandwidth and has associated with it a bin number (position information) and measurement value. The user may select 401, 201, 101, or 51 points per sweep. The larger numbers provide a smoother trace while the lower number of points per sweep allow a shorter **SWEEP TIME**. To select a value for **SWEEP RESOLUTION**, press the **FREQ** hardkey, **SWEEP RESOLUTION** softkey, and then press the softkey corresponding to the desired value.

Note



Changing **SWEEP RESOLUTION** or **SWEEP TYPE** erases registers R, A, and B in trace memory (sets all zeros).

When the display function is group delay, delay aperture is somewhat dependent on sweep resolution. If the sweep resolution is decreased, the HP 3577A automatically increases the delay aperture and displays the screen message "DELAY APERTURE INCREASED."

- EXAMPLE:
1. PRESET; Swp Res = 401, Aperture = .5% of span
 2. Change Swp Res to 201, Aperture changes to 1%
 3. Change Swp Res to 101, Aperture changes to 2%
 4. Return Swp Res to 401, Aperture does not change

FULL SWEEP is a softkey used to reset the start/stop sweep parameters to their maximum values. Full sweep, in a linear sweep, is from 0 to 200 MHz. In log sweep, full sweep is from 5 Hz to 200 MHz. The presence of a test set does not affect full sweep.

Graticule

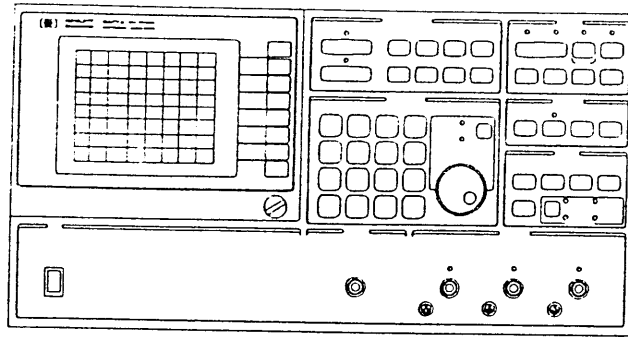

GRATICULE is a scale for measuring quantities displayed on the CRT (referred to as the display screen). The HP 3577A has different graticules for LOG and LINEAR sweep types, POLAR display function and changes the POLAR display graticule to a Smith chart with a softkey in the Scale menu.

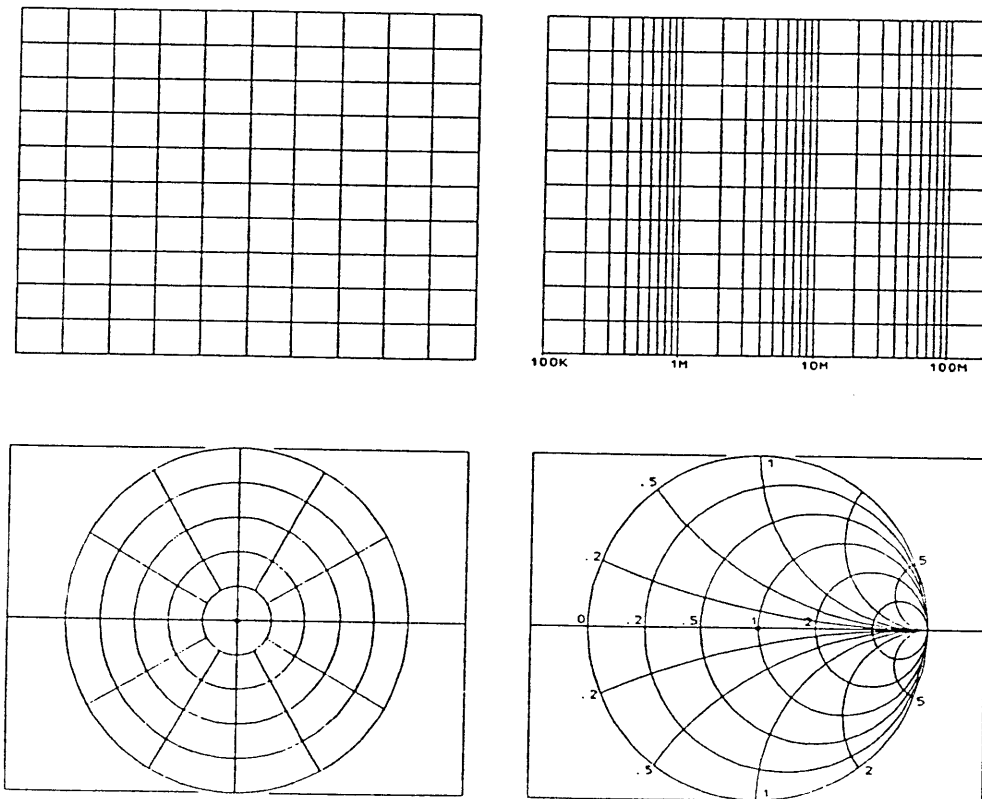

Figure 4-15.

Hardkey

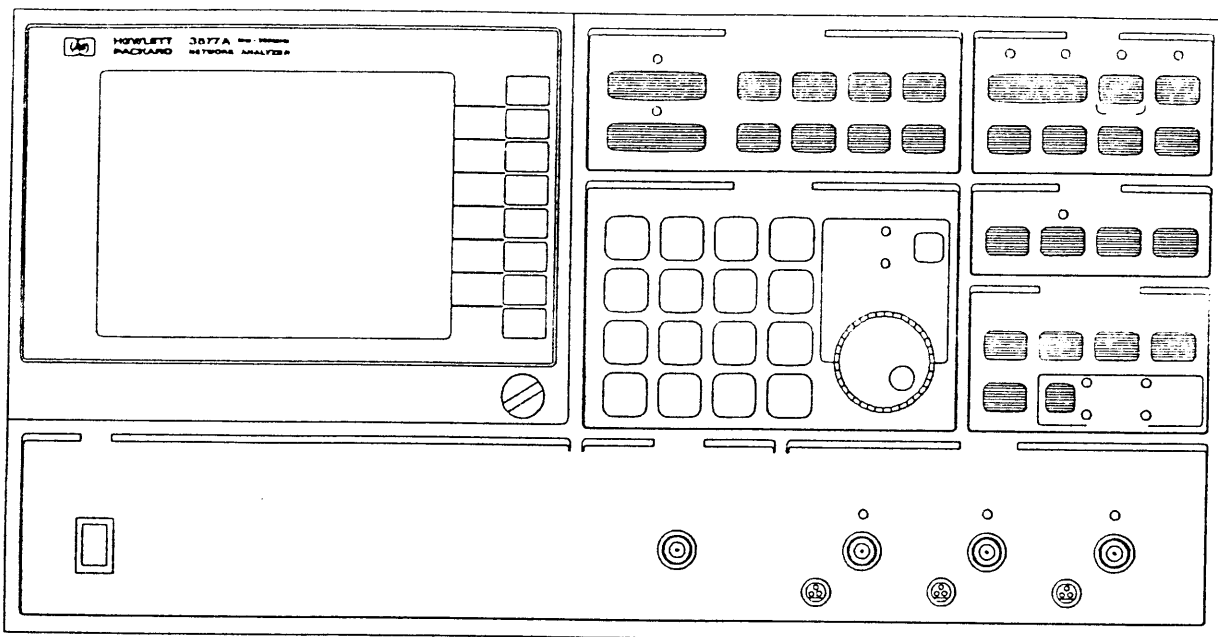

Figure 4-16

HARDKEY refers to all of the keys on the front panel that have command names printed on them. Most hardkeys are used to display a menu of softkey labels. Exceptions to this are the keys in the DATA ENTRY section, the TRIG/RESET key, the LCL key, TRACE 1 and TRACE 2, and the INSTRUMENT PRESET key.

Input

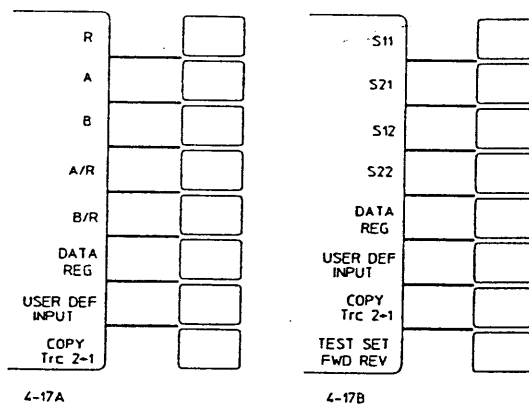
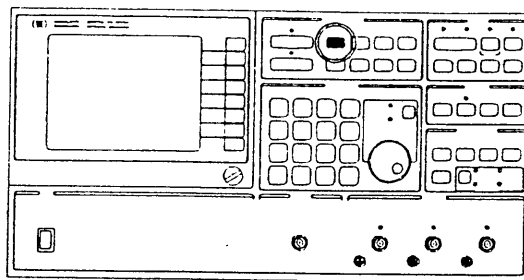

Figure 4-17A/B.

INPUT is a hardkey in the **DISPLAY FORMAT** section used to display the menus of softkeys shown in figure 4-17. These softkeys may be used to define the active trace in terms of

1. Receiver inputs
2. Data registers (contain stored traces)
3. User defined functions
4. User defined complex constants.

Connecting an HP 35677A/B S-parameter Test Set to the HP 3577A changes this menu as shown in figure 4-17B. If the test set is used, the S-parameters may be turned off with a softkey found under the **SPCL FCTN** hardkey. When the S-parameters are turned off, the **INPUT** menu changes to that shown in figure 4-17A.

Without the test set, the default selection for **INPUT** is the R input. When the **INPUT** definition is R, A, or B, the trace appears as a display function of the signal at the selected input. The three inputs are identical. If A/R or B/R are selected as the **INPUT** then the trace consists of the data at the A or B input divided by the data at R. This may be used to remove the response of the source from the trace by using a power splitter as shown in figure 4-17C.

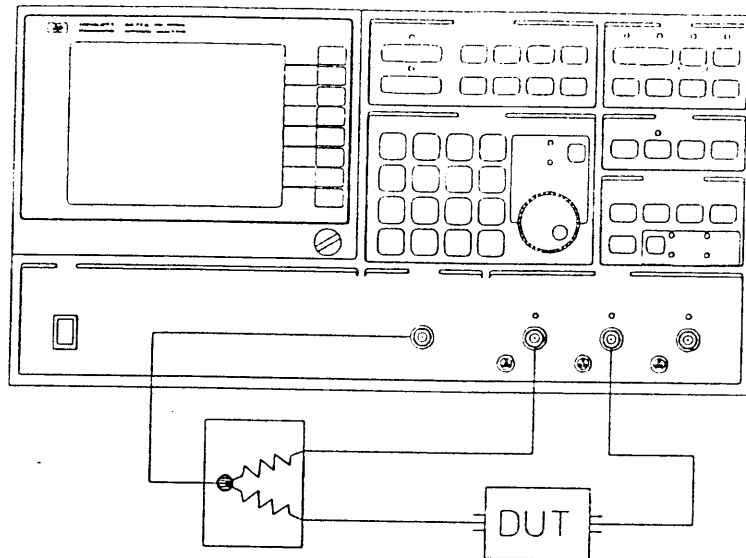

Figure 4-17C

The DATA REG softkey may be used to select one of the four data registers as the **INPUT** definition. The USER DEFINED INPUT softkey may be used to construct an equation using constants, data registers, inputs, and previously defined functions as terms. The user may also copy the **INPUT** definition for the other trace into the definition of the active trace using the Copy Trace softkey.

With the S-parameter test set the **INPUT** menu has most of the same features. In place of the selections for inputs R, A, B, A/R, and B/R are the S-parameters S11, S21, S12, and S22. When the USER DEFINED INPUT is active the softkey label TEST SET FWD/REV appears at the bottom of the menu.

DATA REGISTER is a softkey used to select a trace stored in a data register as the displayed trace. Pressing this softkey changes the menu to a list of the four data registers, D1-D4. Pressing one of these softkeys accomplishes the selection of that data register as the trace INPUT. Be aware that the sweep parameters of the stored trace may be entirely different from those in effect now. **SCALE** parameters are the only values that affect the trace when the **INPUT** is defined to be a data register.

USER DEFINED INPUT is a softkey used to create an equation to define a trace INPUT that is more complicated than the common ones offered at the top of the menu. The user may use

1. The three receiver inputs
2. Three user defined complex constants
3. Four data registers
4. Five user defined functions as terms in this equation.

To make a **USER DEFINED INPUT**:

1. Press the **INPUT** hardkey to display the menu
2. Press the **USER DEF INPUT** softkey (if label is not bright)
3. Press the softkey corresponding to a math term
4. Press the softkey corresponding to a math function
5. Repeat steps 3 and 4 until the equation is complete
6. Press the **ENTER** softkey

COPY Trc n → m is a softkey used to define the **INPUT** of the active trace to be identical to the other trace **INPUT**. The softkey label is **COPY INPUT 2 → 1** when **TRACE 1** is selected and **COPY INPUT 1 → 2** when **TRACE 2** is selected.

TEST SET FWD/REV is a push-push toggle type softkey used to select which of the two S-parameter test set ports is the source. When **FWD** is bright **PORT 1** is the signal source and when **REV** is bright **PORT 2** is the source. This softkey appears only when the **USER DEF INPUT** softkey is active and the test set is connected.

Instrument Preset

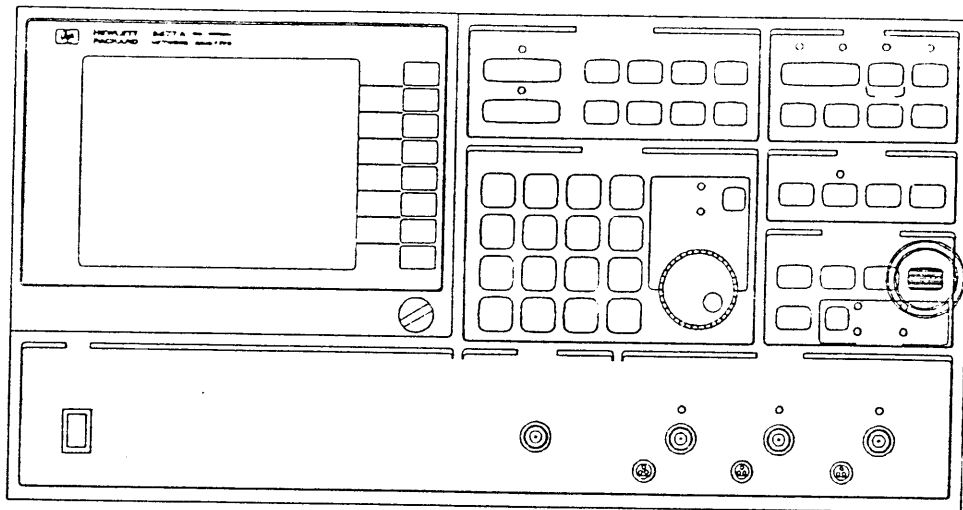

Figure 4-18.

Figure 4-18 **INSTRUMENT PRESET** is a green hardkey in the **INSTRUMENT STATE** section. This key resets the values of HP 3577A parameters to a known state. This operating state is especially useful as a reference condition. Immediately after preset or power-on, the HP 3577A parameters are set to their default values. These parameters and their preset conditions are shown in table 4-1.

Table 4-1

Function	Preset Condition	
	Without test set	With test set
Display function	Log magnitude	same
Input (both traces)	R input	S: 1
Active trace	Trace 1	same
Scale	10 dB/DIV	same
Reference level	0 dBm	same
Reference position	100% (for log mag)	same
Start frequency	0 Hz	100 kHz
Stop frequency	200 MHz	same
Amplitude	- 10 dBm	+15 dBm
Amplitude step size	1 dB	same
Sweep type	Linear frequency	same
Sweep time	1 second	same
Sweep mode	Continuous	same
Sweep resolution	401 points/span	same
Trigger mode	Free Run	same
Resolution bandwidth	1 kHz	same
Averaging	Off	same
Attenuation (input)	20 dB (all 3 inputs)	same
Impedance (input)	50 ohms (all 3 inputs)	same
Length R	On, 0 meters	same
Length A	On, 0 meters	same
Length B	On, 0 meters	On, 1.3 meters
User def constants	$K1 = 10 + j0.0$	same
	$K2 = 50.0 + j0.0$	same
	$K3 = 750 + j0.0$	same
User def functions	$F1 = (B/R) / (K1 - B/R)$	same
	$F2 = A/R$	same
	$F3 = (K1 + F2) / (K1 - F2)$	same
	$F4 = K2 * F3$	same
	$F5 = K3 * F3$	same

Where F1 converts closed loop gain to open loop gain, F2 is input reflection (if the test set is configured forward). F3 converts the reflection measurement to normalized impedance for port 1 of the test set, F4 converts normalized impedance to actual impedance where $Z_o = 50\Omega$, and F5 converts normalized impedance to actual impedance where $Z_o = 75\Omega$. For a more complete listing of preset parameters, refer to the REMOTE OPERATION section.

Instrument State

INSTRUMENT STATE is one of five front panel sections. The hardkeys in this section may be used to **SAVE** and **RECALL** instrument state, **PRESET** the HP 3577A, **PLOT** what appears on the screen, monitor the HP-IB status of the HP 3577A, or use the **SPECIAL FUNCTIONS**.

SPECIAL FUNCTIONS include changing the HP-IB address, confidence testing the HP 3577A, turning the beeper on and off, service diagnostics, and **INPUT** menu S-parameter control.

INSTRUMENT STATE is also a term that refers to the state or values of all parameters. This state may be **SAVED** and later **RECALLED**. For more information on the features described here, refer to the hardkey of interest.

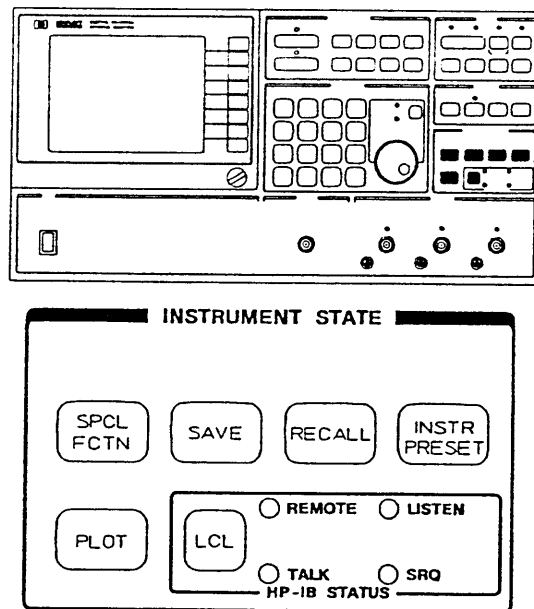

Figure 4-19.

Knob

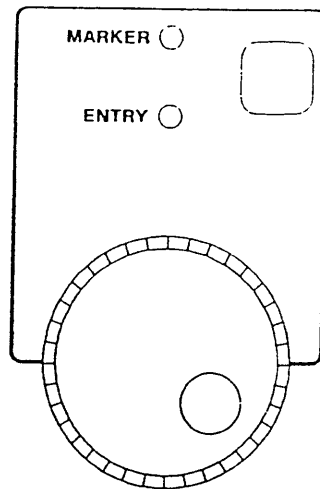

Figure 4-20.

The KNOB in the DATA ENTRY section is used to move the marker or modify data. It is toggled between these two modes with the unmarked key above it. The current mode of the knob is indicated by the LED's above it. The knob may not be used to change the HP-IB address.

Length

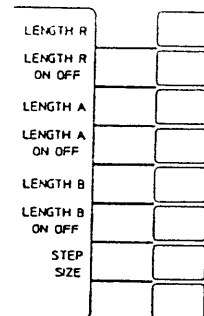
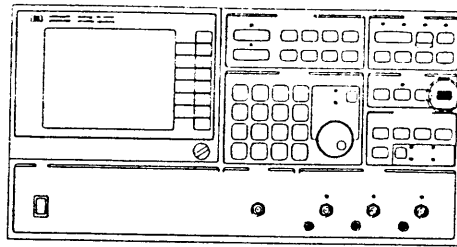

Figure 4-21

LENGTH is a hardkey in the RECEIVER section of the front panel used to display the menu of softkey labels shown above. These softkeys may be used to select the electrical length of each of the receiver inputs to compensate for, or simulate cable lengths. Propagation velocity is assumed to be the speed of light. The actual cable length should be compensated for using a relative velocity. Each input's LENGTH feature may be turned off, which is equivalent to setting its value to 0.

To change the value of length for a receiver input:

1. Press the **LENGTH** hardkey to display the menu
2. Press the softkey LENGTH_ for the channel to be modified (if the label is not bright)
3. Modify the value with the knob or arrow keys

OR

4. Enter a new value with the numeric key pad
Select units from the menu (press a softkey)

Length affects phase functions only; there is no loss factor. If the current **DISPLAY FUNCTION** is LOG or LIN MAG there is no change in the trace with changes in LENGTH.

Preset or default value: 0.0m, ON (without test set)
Upper limit: 1 second or 300,000,000 meters
Lower limit: - 1 second or - 300,000,000 meters
Resolution: .001 ns or .1 cm
Menu Units: m, cm, SEC, mSEC, μ SEC, nSEC, EXP

Local

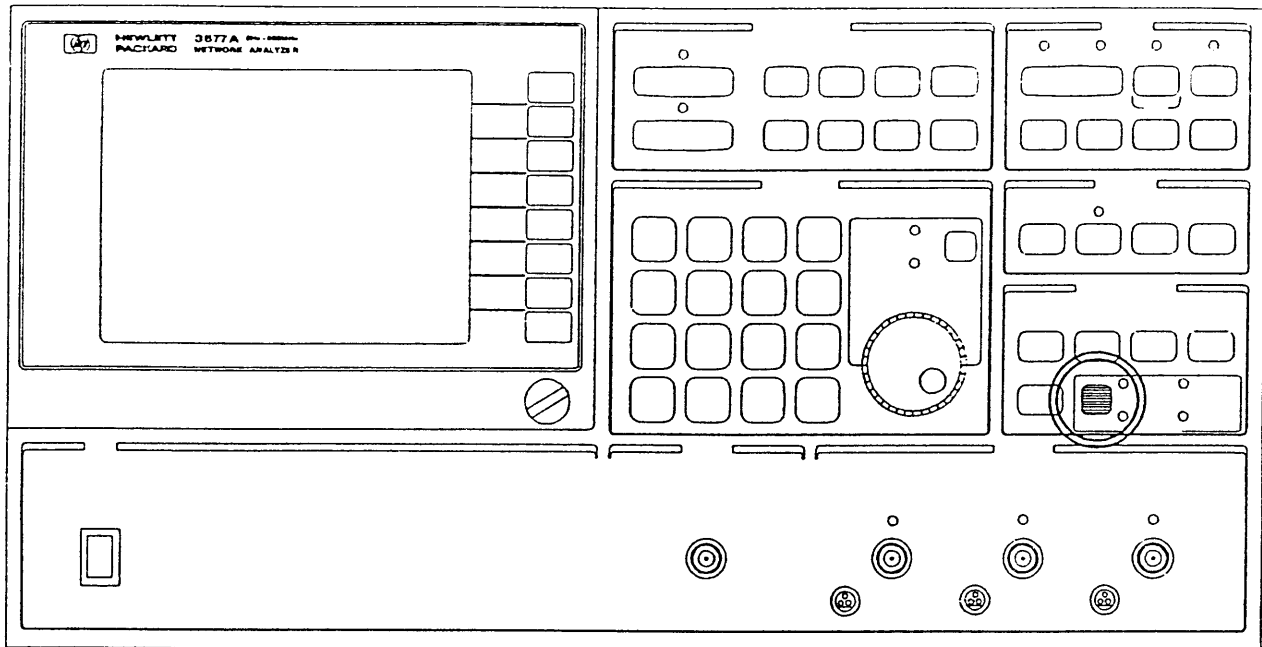

Figure 4-22.

LOCAL is a hardkey in the INSTRUMENT STATE section of the front panel used to change the HP-IB status of the HP 3577A from REMOTE to LOCAL if the LOCAL LOCKOUT command has not been issued.

The **LCL** key is part of the HP-IB STATUS block. This block has four LED indicators that show the HP-IB status for REMOTE, TALK, LISTEN, and SRQ. If the REMOTE LED is illuminated, the front panel keys are disabled until the **LCL** key returns LOCAL control (which extinguishes the REMOTE LED). If the HP-IB controller has issued the LOCAL LOCKOUT command and the REMOTE LED is illuminated, the **LCL** key, too, is disabled. See the section on remote operation.

Marker

MARKER is a hardkey in the DISPLAY FORMAT section of the front panel used to display the menus of softkey labels shown in figure 4-23. These softkeys may be used to read data from the displayed trace. After being **PRESET** the HP 3577A's knob is in the marker position mode. The marker (small circle) may be moved to any part of the trace with the knob and the data for that point appears in the **MARKER BLOCK** above the right half of the graticule. Note that the **MARKER** information is valid even though the trace may be clipped by the upper or lower edges of the graticule. The arrow keys may also be used to move the marker across the trace. If the frequency span is 0 Hz and the sweep time is less than 1000 seconds, the marker position reads out in units of time.

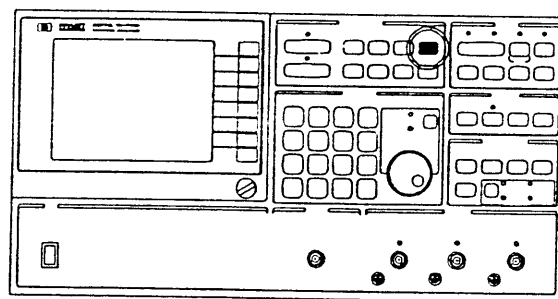

MARKER POSN		
MARKER ON OFF		
ZERO MARKER		
MKR OFST ON OFF		
MARKER OFFSET		
FREQ OFFSET		
MKR CPL ON OFF		

4-23A Rectangular

MARKER POSN		
MARKER ON OFF		
ZERO MARKER		
MKR OFST ON OFF		
MAG OFFSET		
PHASE OFFSET		
FREQ OFFSET		
MARKER H/P RJ		

4-23B Polar

Figure 4-23.

MARKER POSITION is a softkey which must be selected when the arrow keys are used to move the marker. Note that when **MARKER POSITION** is bright the knob moves the marker in either the **MARKER** or **ENTRY** modes.

MARKER ON/OFF is a push-push toggle type softkey used to turn the marker and the **MARKER BLOCK** off and back on. The default condition is on. If the marker is off, pressing the **MKR** hardkey turns it on.

ZERO MARKER is a softkey which turns on the **OFFSET MARKER** and sets its X-Y coordinates (offset values) to those of the regular marker. This marker appears as a small triangle on top of the regular marker (which is a small circle). When **ZERO MARKER** is activated the marker information block above the graticule contains **OFFSET** information. The offset marker becomes the reference for the regular marker.

MARKER OFFSET ON/OFF is a softkey used to turn on the offset marker at the values represented by the **MARKER OFFSET** (magnitude) and **FREQ OFFSET** parameters. This is a push-push toggle type softkey. When on, the triangular offset marker appears on the screen (if its coordinates are on-scale) and the word "**MARKER**" changes to "**OFFSET**" in the marker block above the graticule.

MARKER OFFSET is a softkey used to enter a reference value for the Y-axis of the **OFFSET MARKER**. The default value for **MARKER OFFSET** is 0.0 dBm. To change this value:

1. Press the **MKR** hardkey to display the menu
2. Press the **MARKER OFFSET** softkey (if label is not bright)
3. Modify the data with the knob or arrow keys

OR

4. Enter a new value with the numeric key pad
Select units from the menu (press a softkey)

FREQUENCY OFFSET is a softkey that allows the user to enter a reference value for the X-axis of the **OFFSET MARKER**. The default value for **FREQUENCY OFFSET** is 0 Hz (in a frequency sweep). When **SWEEP TYPE** is **AMPLITUDE** this softkey label reads "**AMPLITUDE OFFSET**." This parameter may be modified in the same manner as **MARKER OFFSET**.

Reference
Marker

MARKER COUPLING ON/OFF is a push-push toggle type softkey used when two traces are on. In the default setting (ON) both markers move together when the knob is rotated. If **MARKER COUPLING** is turned OFF, turning the knob moves only the marker on the active trace.

When the **DISPLAY FUNCTION** is **POLAR** only one trace is active, so there is only one active marker. This marker has three values associated with it; frequency, magnitude and phase (or frequency, real, and imaginary). With the **POLAR DISPLAY FUNCTION** the **MKR** menu appears as shown in figure 4-23B. The following discussion of softkey features assumes that the active display function is **POLAR**. The top four softkey labels operate in the **POLAR DISPLAY FUNCTION** the same as they do in a rectangular display function.

MAGNITUDE OFFSET is a softkey used to enter or modify the value of magnitude for the offset marker. The default value of magnitude offset is 0.0V without a test set and 0.0 units with a test set. Pressing the **ZERO MARKER** softkey resets this value to the current magnitude value of the regular marker. This softkey label changes to read "REAL OFFSET" when the selected units are changed with the **MARKER M,P R,I** softkey. To change the value of this parameter:

1. Press **DSPLY FCTN** hardkey to display a menu
2. Press the **POLAR** softkey (if label is not bright)
3. Press the **MKR** hardkey to display a menu
4. Press the **MAG OFFSET** softkey (if label is not bright)
5. Modify the value with the knob or the arrow keys
OR
6. Enter a new value for **MAG OFFSET** with the numeric key pad
Select units from menu (press a softkey)

PHASE OFFSET is a softkey which allows data entry of the phase data to place the offset marker as a reference for the regular marker. This parameter value may be entered or modified in the same manner as described previously for **MAGNITUDE OFFSET**. The **OFFSET MARKER** may be on or off when this is done. Pressing the **ZERO MARKER** softkey resets this data to the current phase of the regular marker. The softkey label changes to **IMAGINARY OFFSET** when the units are changed with the softkey at the bottom of the menu from magnitude & phase to real & imaginary. This is described later in this discussion.

FREQUENCY OFFSET is a softkey that operates the same in the **POLAR** as in a rectangular display function. Note that in polar display function, changing this value does not change the screen position of the offset marker. The value of this parameter may be modified to offset the frequency readout in the marker information block.

MARKER M,P R,I is a push-push toggle type softkey which changes the units of the marker information from magnitude & phase to real & imaginary. The default setting is magnitude and phase units. To change the units to real and imaginary, press the **MARKER M,P R,I** softkey once. Pressing it a second time returns the units to magnitude and phase. The selected unit type is indicated by bright letters **M,P** for magnitude and phase or bright letters **R,I** for real and imaginary.

Marker →

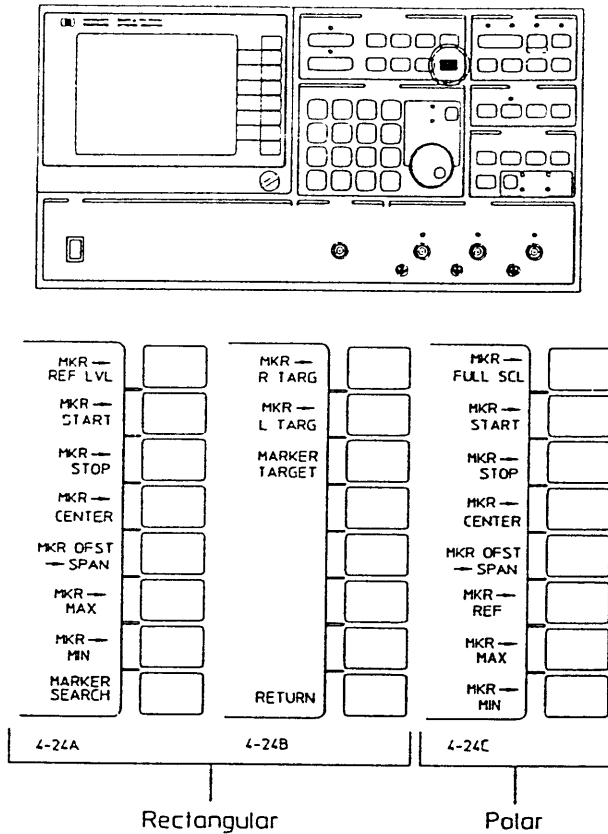

Figure 4-24.

MARKER → is a hardkey in the DISPLAY FORMAT section of the front panel used to display the menus of softkeys shown above. Some of these softkeys may be used to enter data corresponding to the position of the marker. Others move the marker to points of interest.

MARKER → REFERENCE LEVEL is a softkey used to change the current value of reference level to the magnitude (position) of the marker. This redefines the level at the dashed line such that the trace moves up or down putting the marker on the reference line. To use this feature:

1. Move the marker to the point on the trace whose magnitude you wish to be the new reference level (dashed line value)
2. Press the **MARKER →** hardkey to display the menu
3. Press the **MARKER → REF LVL** softkey

Reference
Marker →

MARKER → START FREQ is a softkey used to change the current value of start frequency to the frequency (position) of the marker. To use this feature:

1. Move the marker to the point on the trace that you wish to be the new start frequency
2. Press the **MKR →** hardkey to display the menu
3. Press the **MKR → START** softkey

MARKER → STOP FREQ is a softkey used to change the current value of stop frequency to the frequency (position) of the marker. To use this feature:

1. Move the marker to the point on the trace that you wish to be the new stop frequency
2. Press the **MKR →** hardkey to display the menu
3. Press the **MKR → STOP** softkey

MARKER → CENTER FREQ is a softkey that allows the present frequency of the marker to be entered into the center frequency value. To use this feature:

1. Move the marker to the point on the trace that you wish to be the new center frequency
2. Press the **MKR →** hardkey to display the menu
3. Press the **MKR → CENTER** softkey

MARKER OFFSET → SPAN is a softkey used to select new **START** and **STOP** frequencies (i.e., frequency span). The start and stop frequencies are selected by positioning the reference and regular markers. To use this feature:

1. Move the marker to the point on the trace that you wish to be one of the end frequencies
2. Press the **MKR** hardkey to display a menu
3. Press the **ZERO MARKER** softkey to turn on the offset marker
4. Move the marker to the point on the trace that you wish to be the other end frequency
5. Press the **MKR →** hardkey to display the menu
6. Press the **MKROFST → SPAN** softkey

MARKER → MAX is a softkey used to move the marker to the bin containing the largest value. To use this feature:

1. Press the **MKR →** hardkey to display the menu
2. Press the **MKR → MAX** softkey

MARKER → MIN is a softkey used to move the marker to the bin containing the smallest value. To use this feature:

1. Press the **MKR →** hardkey to display the menu
2. Press the **MKR → MIN** softkey

Note that if future sweeps create maximum or minimum values in bins other than the position of the marker, the marker does not move to that bin. The marker remains at the position selected through the use of the last **MKR → MIN** or **MKR → MAX** softkey.

MARKER SEARCH is a softkey used to search for a target value defined by the user. Pressing this softkey displays a new menu shown in figure 4-24B. The active softkey in this menu is **MARKER TARGET**.

MARKER → RIGHT TO TARGET is a softkey used to search to the right for the target value entered by the user. The default value of the **MARKER TARGET** is 10.01 dBm without the test set and -3 dB with the test set. To use this feature:

1. Press **MKR →** hardkey to display a menu
2. Press the **MARKER SEARCH** softkey to display the second menu
3. Press the **MKR → R TARG** softkey

If the target value does not exist to the right of the marker, the screen message “**TARGET VALUE NOT FOUND**” appears and the marker does not change position. If the value exists in more than one bin the marker moves in the selected direction to the first bin containing the value closest to the target value. Refer to the marker information block above the graticule.

Reference
Marker →

MARKER → LEFT TO TARGET is a softkey used to search to the left for the Target value entered by the user. The default value of the **MARKER TARGET** is 10.01 dBm without a test set and -3 dB with a test set. To use this feature:

1. Press the **MKR →** hardkey to display a menu
2. Press the **MARKER SEARCH** softkey to display the second menu
3. Press the **MKR → L TARG** softkey

If the target value does not exist to the left of the marker, the screen message "TARGET VALUE NOT FOUND" appears and the marker does not change position. If the value exists in more than one bin the marker moves to the closest bin containing the target value. The bin value is not necessarily exactly equal to the target value. Refer to the marker information block above the graticule.

MARKER TARGET is a softkey used to enter a value to search for with the marker. The default value of the target is 10.01 dBm without a test set and -3 dB with a test set. To use this feature:

1. Press the **MKR →** hardkey to display a menu
2. Press the **MARKER SEARCH** softkey to display the second menu
3. Modify the value with the knob or arrow keys

OR

4. Enter a new value with the numeric key pad
Select units from the menu (press a softkey)

RETURN is a softkey that displays the previous menu. This may also be done by pressing the **MKR →** hardkey.

When the **DISPLAY FUNCTION** is **POLAR** the **MKR →** menu appears with different softkey labels than when the **DISPLAY FUNCTION** is one of the rectangular formats as shown in figure 4-24C. The following discussions of softkey features assume that the active display function is polar.

MARKER → FULL SCALE is a softkey used to change the value of **FULL SCALE** to the magnitude (position) of the marker. This sets the level of the outer ring of the polar graticule to the current magnitude of the marker which has the effect of changing the scale. To use this feature:

1. Move the marker to the point you wish to be on the outer ring of the polar graticule
2. Press the **MKR →** hardkey to display the menu
3. Press the **MKR → FULL SCL** softkey

MARKER → START FREQUENCY is a softkey that also appears in the MKR menu for rectangular display formats. It works the same for polar formats. In POLAR there is only one trace and only one marker. The marker has three values associated with it: frequency, magnitude, and phase (or frequency, real, and imaginary). The MKR → START FREQ softkey puts the present frequency value of the marker into the start frequency value.

MARKER → STOP FREQUENCY is a softkey that works the same in polar as rectangular display formats.

MARKER → CENTER FREQUENCY is a softkey that works the same in polar as rectangular display formats.

MARKER OFFSET → FREQ SPAN is a softkey that works the same in polar as rectangular display formats.

MARKER → REFERENCE is a hardkey that puts the current phase value of the marker into the value of the reference line. This has the effect of rotating the polar trace, leaving the marker on the dashed line. To use this feature:

1. Move the marker to the point on the trace that you wish to be the new phase reference
2. Press the MKR → hardkey to display the menu
3. Press the MKR → REF softkey

MARKER → MAX is a softkey that works the same in polar as rectangular display formats.

MARKER → MIN is a softkey that works the same in polar as rectangular display formats.

Measurement Calibration

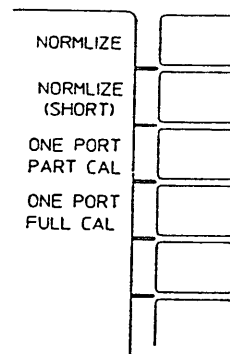
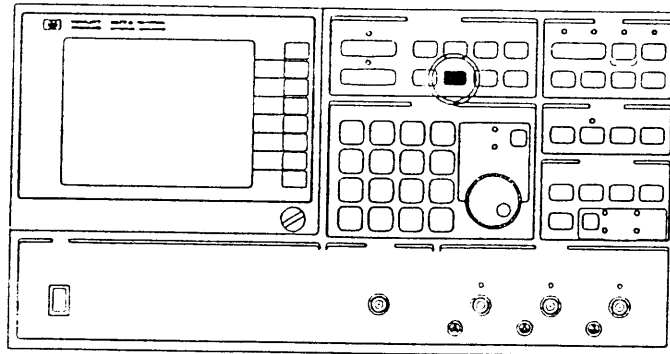

Figure 4-25.

MEASUREMENT CALIBRATION is a hardkey in the **DISPLAY FORMAT** section of the front panel used to display the menu of softkeys shown in the figure above. Items in the **MEASR CAL** menu help the user calibrate out the effects of measurement hardware imperfections. None of these softkey functions are operable if the active sweep type is alternate sweep.

NORMALIZE is a softkey that is used to remove cable lengths and imperfections in the source flatness from simple measurements. To use this feature:

1. Set up the measurement
2. Replace the device under test with a through (barrel adapter)
3. Wait for a full sweep update of the trace
4. Press the **MEASR CAL** hardkey to display the menu
5. Press the **NORMLIZE** softkey
6. Replace the barrel with the test device

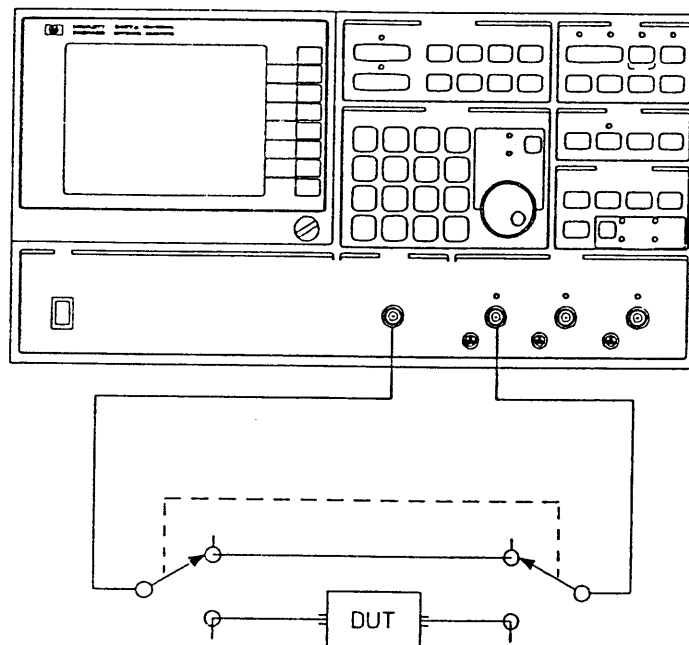

Figure 4-26.

To normalize, the HP 3577A uses the INPUT as it is originally defined to store the trace in register D1 (for trace 1) or D2 (for trace 2). Then it redefines the INPUT to be "old INPUT"/D1 or "old INPUT"/D2, whichever applies (dependent on trace being operated on).

NORMALIZE may also be used to calibrate a reflection measurement. The configuration shown in figure 4-27 should be used with an open as the standard. The procedure is the same as previously described except that, instead of replacing the device under test with a through 1 meg, the D.U.T. should be disconnected and the connection to the directional bridge left open.

NORMALIZE (SHORT) may be used in the same manner as **NORMALIZE** for normalizing single port (reflection) measurements. The standard used should be a short.

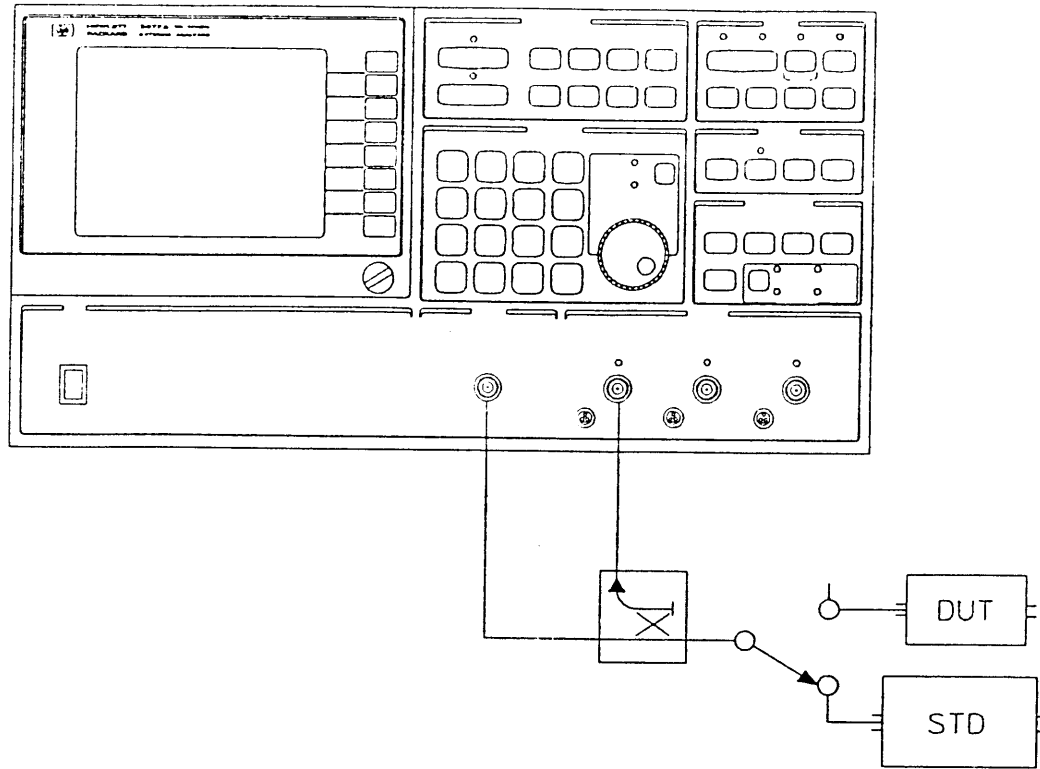
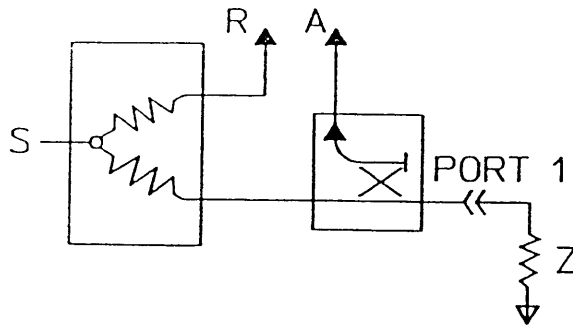

Figure 4-27.

Note



The HP 3577A does not allow normalization of INPUT expressions other than A, B, R, A/R, OR B/R.



$$M_{\text{actual}} = \frac{M_{\text{meas}} - D}{F} \quad \text{where:}$$

$$D = \Gamma_i \quad \Gamma_i = \frac{A}{R} \Big|_{Z=Z_0} \quad \Gamma_{\text{oc}} = \frac{A}{R} \Big|_{Z=\text{open}}$$

$$F = \Gamma_i - \Gamma_{\text{oc}}$$

Figure 4-28.

ONE PORT PARTIAL CAL is a softkey label in the MEASUREMENT CALIBRATION menu used to improve accuracy of return loss measurements by doing two-term error correction. Use of this feature destroys the contents of registers D3 and D4 and redefines the function F2 and the constant K1. To use this feature:

1. Set up the measurement (**INPUT, FREQ, AMPTD, SWEEP TIME** etc.)
2. Press the **MEASR CAL** hardkey to display the menu
3. The HP 3577A displays a screen message to **LEAVE PORT 1 OPEN**
4. Disconnect the cable to PORT 1
5. Press the **CONTINUE CAL** Softkey
6. Wait for the HP 3577A to do a complete sweep
7. The HP 3577A displays a message to **INSTALL REFERENCE LOAD ON PORT 1** of the HP 35677A/B S-parameter test Set
8. Install a calibrated load of characteristic impedance on PORT 1 of the HP 35677A/B S-parameter test set
9. Press the **CONTINUE CAL** softkey
10. Wait for the message **CALIBRATION COMPLETE**
11. Reconnect the device to be tested to PORT 1

When calibration is complete the INPUT is the user defined function F2, calibrated reflection. To display the normalized impedance function select INPUT = F3 as follows:

1. Press the **INPUT** hardkey to display the menu
2. Press the USER DEF INPUT softkey
3. Press the F_ softkey
4. Press the 3 softkey (or 3 in the numeric key pad)
5. Press the ENTER softkey

To display the definition of F3:

1. Press the **DEFINE MATH** hardkey
2. Press the DEFINE FUNCTION softkey
3. Press the F3 softkey and read “(K1+F2)/(K1-F2)” in the entry block portion of the screen

The error model expression is $M_{meas} = D + F \cdot M_{actual}$ where D is the directivity error term and F is the frequency response error term. When calibrated the HP 3577A displays $M_{actual} = (M_{meas} - D) / F$.

To solve for M_{actual} , the HP 3577A stores A/R measured with an open termination into D4. Then it stores the directivity error term D (with the standard load) in D3 and redefines D4 to be D4-D3, the frequency response error term F. The user defined function F2 is now the calibrated reflection function used to solve for M_{actual} ; $F2 = (A/R - D3) / D4$ which represents $M_{actual} = (M_{meas} - D) / F$.

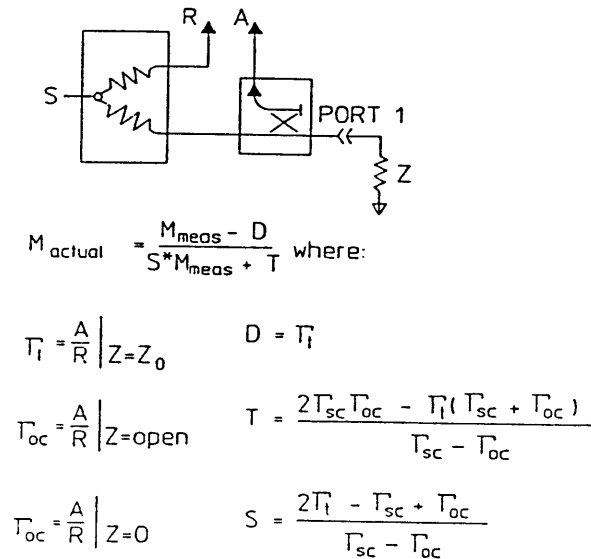

Figure 4-29.

ONE PORT FULL CAL is a softkey label in the MEASUREMENT CALIBRATION menu used to improve return loss measurement accuracy. Use of this feature destroys the contents of data registers D1 (for trace 1) or D2 (for trace 2), D3, and D4, and redefine F1, F2, and K1.

Use of this feature is identical to that of the two-term error correction described previously, with the addition of a step requiring that PORT 1 of the S-parameter test set be terminated with a short. Messages on the screen ask the user to LEAVE PORT 1 OPEN, INSTALL SHORT ON PORT 1, and INSTALL REFERENCE LOAD ON PORT 1 (of the S-parameter test set). After each termination is connected, the CONTINUE CAL softkey is pressed and the HP 3577A collects data by sweeping over the selected frequency range (during which we must patiently wait). When this sequence is complete, F2 is the displayed trace and has been defined to be the CALIBRATED REFLECTION. The normalized impedance function may be displayed by selecting F3 for the user defined INPUT, as previously described.

The error model expression used for the 3-term correction function is $M_{meas} = (D + T * M_{actual}) / (1 - S * M_{actual})$ where D is the correction factor for directivity, T is the correction factor for transmission and S is the factor for source match. When calibrated, the HP 3577A displays $M_{actual} = (M_{meas} - D) / (S * M_{meas} + T)$.

To solve for M_{actual} , the HP 3577A stores A/R measured with the open termination in D3. Then it requests the short termination and stores (A/R) + D3 in D4, stores (A/R) - D3 in D1 (or D2, depending on the active trace) defines $K1 = 2 + j0$, and stores $K1 * A/R * D3$ in D3. Next, it requests a standard load and stores $D3 - A/R * D4$ in D3, stores $D3/D1$ (or D2) in D3 (which is now used as the error term B), stores $K1 * A/R - D4$ to D4, stores $D4/D1$ (or D2) to D4 (now equivalent to the error term C), and stores A/R in D1 (or D2) (which is A in the error model expression). Finally, it defines $F1 = D4 * A/R + D3$ and $F2 = (A/R - D2) / F1$.

Note



Changing either START or STOP frequencies destroys the calibration. Be sure to repeat normalization or calibration after any frequency modification.

Menu

A **MENU** is a list of softkey labels that is displayed on the CRT next to the column of softkeys. This part of the display is called the MENU AREA.

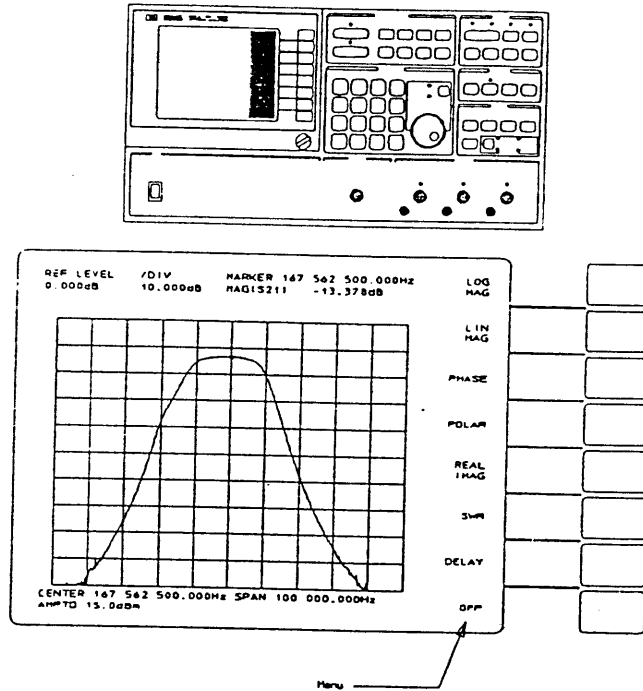

Figure 4-30.

No menu contains more than eight softkey labels. Each softkey label is associated with the softkey beside it such that pressing its softkey effects the command represented by the softkey label.

Menus change whenever a hardkey is pressed or, when a menu is more than one level deep certain softkeys are pressed (see figure 4-31).

Hardkeys are the stenciled keys on the front panel that do not change definition. Hardkeys (excluding the DATA ENTRY section) are used to display menus of softkey labels. Five hardkeys that do not display a menu are **INSTR PRESET**, **LCL**, **TRACE 1** and **TRACE 2**, and **TRIG/RESET**.

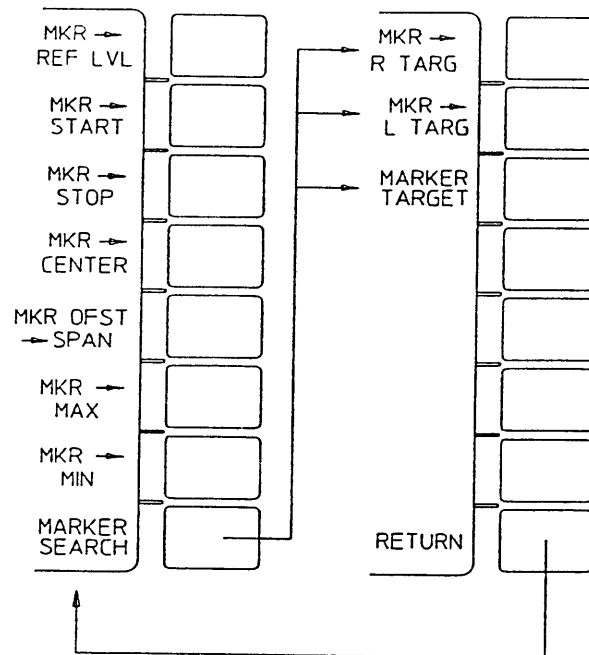

Figure 4-31.

Message Block

The **MESSAGE BLOCK** is the area within the graticule in which messages appear. See figure 4-32. These messages may be warning, error, or general information messages. For a listing of these messages see Appendix C.

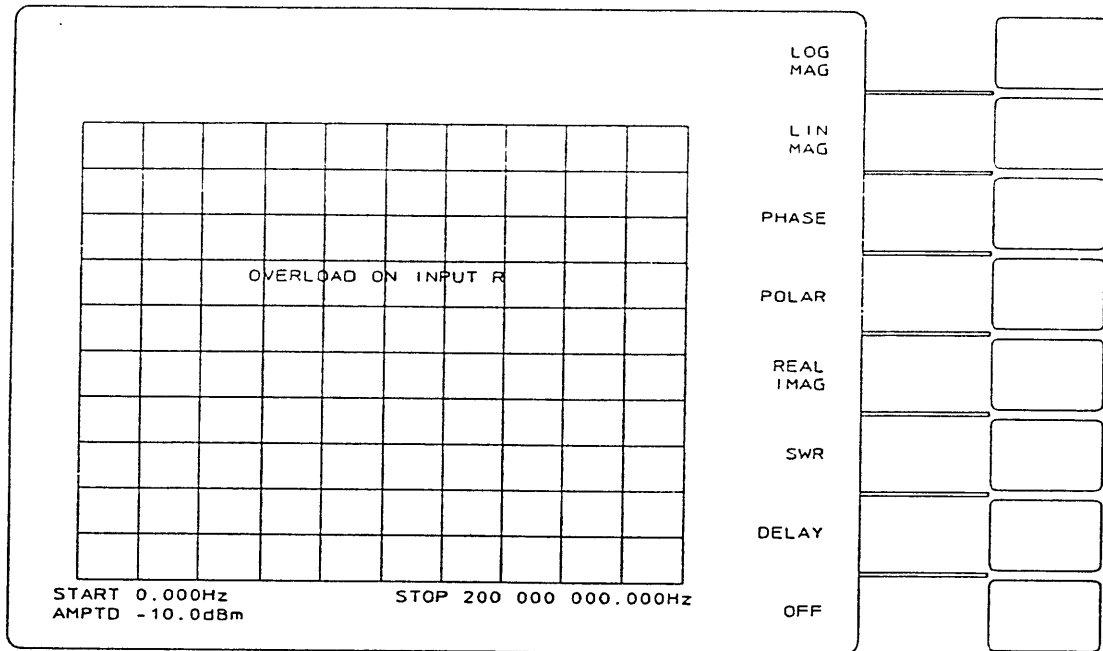

Figure 4-32.

Output

The **OUTPUT** of the HP 3577A is the signal source. It is located at the lower center position on the front panel and is the left-most of the four type-N connectors arranged along the bottom. The **OUTPUT** signal is controlled by the keys in the **SOURCE** section of the front panel. The characters across the bottom of the CRT show the status of the frequency and amplitude of the source. In **LOG** and **ALTERNATE** sweep modes the amplitude information does not appear on the screen.

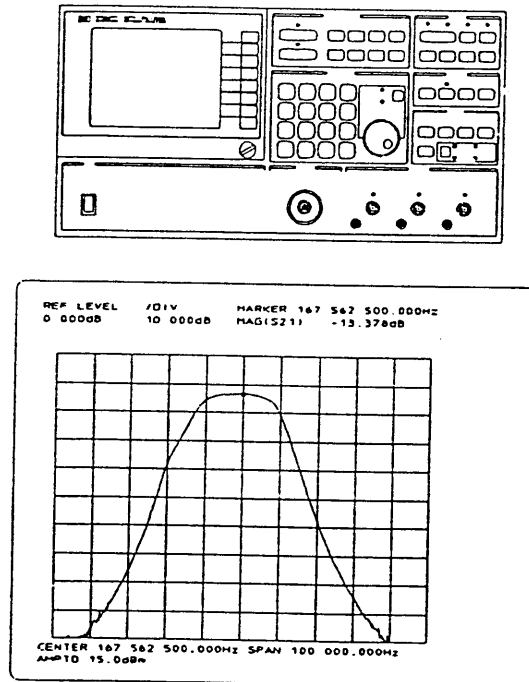

Figure 4-33. Output Signal Information

The **OUTPUT** has protection circuitry that disconnects the output port if a signal level greater than 4V appears on the connector. This open condition is called **TRIPPED**. The screen message "SOURCE TRIPPED, Clear trip on AMPTD menu" directs the user to the **AMPTD** menu where the softkey **CLEAR TRIP** may be found.

Overload

OVERLOAD occurs when a signal level larger than 0.0 dBm (with **ATTEN** = 20 dB) or -20 dBm (with **ATTEN** = 0 dB) is applied to one of the three receiver inputs. (If the frequencies of interest are below 10 kHz, reduce these signal levels 6 dB). When an input is overloaded the measurement accuracy is degraded and action should be taken to reduce the input level. When an overload occurs, the HP 3577A sounds an audible alarm (if the beeper is ON), illuminates the red **OVERLOAD** LED above the input being overloaded, and displays a warning message on the screen. The red alarm LED is a real-time indication of an overload condition while the screen message remains until the beginning of a new sweep.

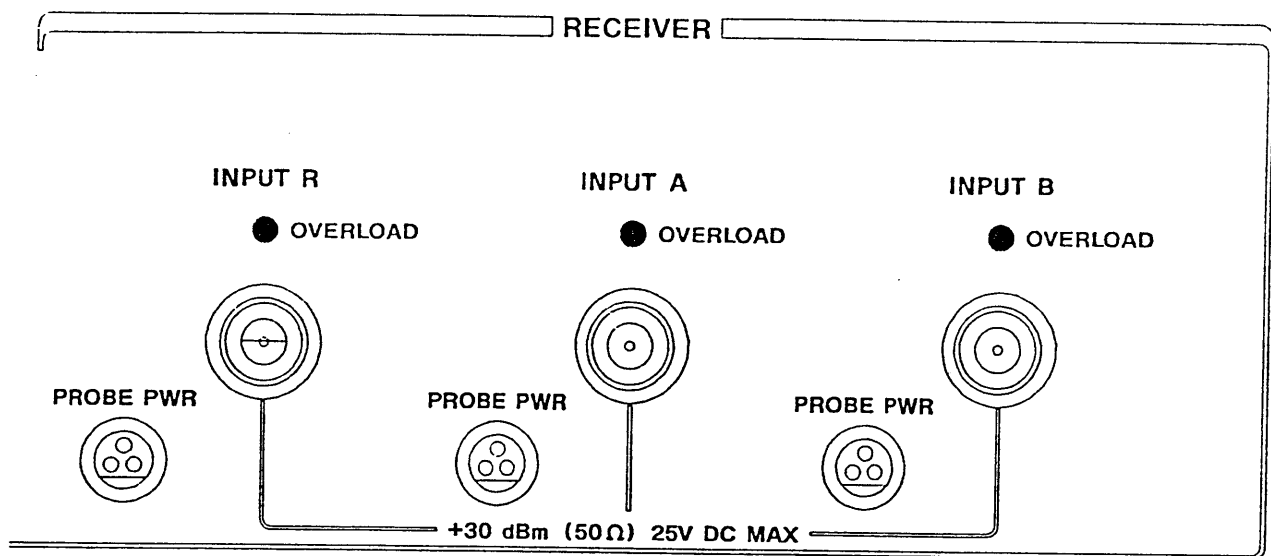

Figure 4-34.

Note



If an overload occurs during a slow or single sweep, inaccurate trace data may remain on the screen. It is recommended that a new sweep be taken with reduced input levels before measurement values are taken.

If the signal level is increased to 1.1V the receiver input TRIPs (changes to 1 MΩ impedance) to protect itself from damage. To reset the TRIP press the **ATTEN** hardkey and then the **CLEAR TRIP** softkey. Note that the TRIP changes the impedance of the input but the **ATTEN** menu shows an impedance of 50Ω. The impedance shown in the menu is a user selection, not the active impedance value.

Plot

PLOT is a hardkey in the INSTRUMENT STATE section of the front panel used to display the menus of softkeys shown in figure 4-35A. These softkeys are used to reproduce the display screen on paper, using an HP-IB plotter. The plotter must be configured to LISTEN ONLY and the HP 3577A must be in the TALK ONLY mode (press **SPCL FCTN** hardkey, then the TALKONLY ON/OFF softkey so that "ON" is bright). Connect the HP-IB ports of the plotter and the HP 3577A with an HP-IB cable. (Refer to "INSTALLATION" in the GENERAL INFORMATION section).

PLOT ALL is a softkey used to plot the active traces, the active markers, the graticule, and the alphanumerics above and below the graticule. When pressed, the plot begins, the screen message PLOT IN PROGRESS appears, and the menu changes to ABORT PLOT. Line types and pen numbers used are discussed under CONFIGURE PLOT. ABORT PLOT allows the user to interrupt the plot and the original menu returns. After a plot is aborted, it cannot be restarted where it stopped.

While the plot is in progress, ABORT PLOT is the only softkey label in the menu area. All other front panel keys (except INSTR PRESET) are ignored. ABORT PLOT may not stop the plot immediately. The delay depends on the time required for the plotter to execute the last command sent to it by the HP 3577A.

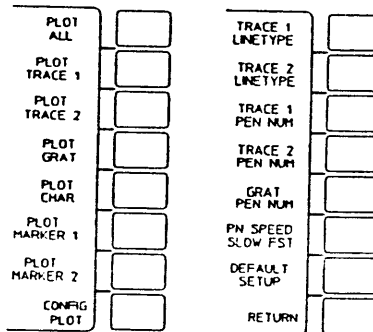
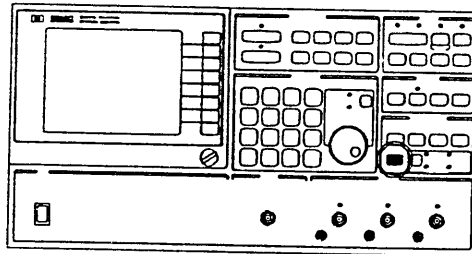

4-35A

4-35B

Figure 4-35.

Reference
Plot

PLOT TRACE 1 is a softkey used to plot only trace one. When pressed, trace one and any active markers on it are plotted. The plot may be interrupted by using the **ABORT PLOT** softkey as described in **PLOT ALL**.

PLOT TRACE 2 is a softkey that plots trace two exactly as described above for **PLOT TRACE 1**.

PLOT GRATICULE is a softkey used to plot the active graticule and reference lines. The reference lines are plotted using the pen (number) selected for plotting its associated trace. Pressing **ABORT PLOT** interrupts the plot. If you don't want to plot the reference lines, turn them off with softkeys in the **SCALE** menu.

PLOT CHARACTERS is a softkey that plots the alphanumeric characters above and below the graticule. Pressing **ABORT PLOT** interrupts the plot.

PLOT MARKER 1 or 2 are softkeys used to plot multiple markers. This allows the user to mark many points of interest on the plot. The "extra" markers appear as a cross hair on the trace and the marker block information is plotted next to it. If the marker is near one of the edges of the graticule the marker information is moved such that it all appears on the graticule. Information blocks may overwrite each other if the markers are close. See figure 4-36. To use this feature:

1. Move the marker to the point of interest on the trace
2. Press the **PLOT** hardkey to display the menu
3. Press the **PLOT MARKER_** softkey (1 =trace 1, 2=trace 2)

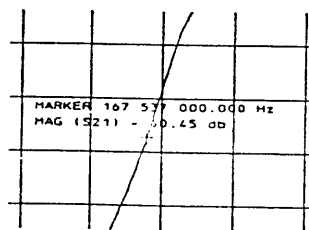
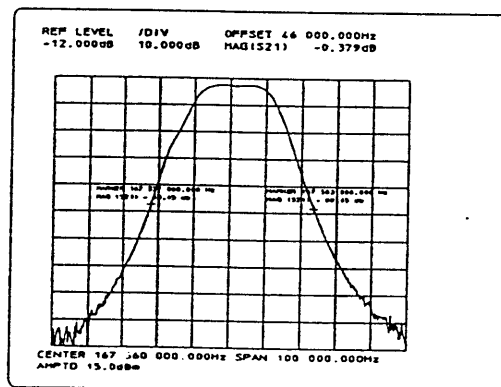

Figure 4-36.

CONFIGURE PLOT is a softkey used to select pens, line types and pen velocity. Pressing this softkey changes the menu listing as shown in figure 4-35B. These parameters are not affected by use of the **INSTR PRESET** hardkey and are not saved with instrument state. See **DEFAULT SETUP** later in this discussion.

TRACE 1 LINETYPE is a softkey used to select the plotter line type (solid, dashes, dots, etc.) for trace 1. The line type available is dependent on the plotter. The default value is 7 (a solid line) and the range is 0-7. To select a line type:

1. Press the **PLOT** hardkey to display the menu
2. Press the **CONFIGURE PLOT** softkey
3. Press the **TRACE 1 LINETYPE** (if label is not bright)
4. Modify the value with the knob or arrow keys

OR

5. Enter a new value with the numeric key pad
Press the **UNITS** softkey

TRACE 2 LINETYPE is a softkey used to select plotter line type for trace 2 as described for trace 1 above. The default value for **TRACE 2 LINETYPE** is 7 (solid).

TRACE 1 PEN NUMBER is a softkey used to select the plotter pen number for trace 1. This pen is also used to plot the alphanumeric information associated with trace 1. The default value for **TRACE 1 PEN NUMBER** is 1. Pen number is modified in the same manner as linetype. The range of pen numbers is 0-8.

TRACE 2 PEN NUMBER is a softkey used to select the plotter pen number for trace 2 as described for trace 1. The default value for **TRACE 2 PEN NUMBER** is 2. **PEN NUMBER** is modified in the same manner as linetype in the range 0-8.

GRATICULE PEN NUMBER is a softkey used to select the plotter pen number for the graticule and any alphanumeric information that is associated with both traces. This information includes "REF", "/DIV", start and stop or center and span frequencies (when not in Alternate Sweep Type), and source amplitude (when not in Alternate or Log Sweep Type). In Alternate Sweep the frequency information is associated with a specific trace, so pen numbers selected by trace are used and amplitude information does not appear. In log freq sweep, amplitude information does not appear at the bottom of the screen. The default value of **GRATICULE PEN NUMBER** is 2. This parameter may be modified in the same manner as linetype. The range of numbers allowed as data for this entry is 0-8.

Reference
Plot

PEN SPEED SLOW/FST is a softkey used to select either a slow pen velocity or the maximum. The default setting is FST. This pen velocity is dependent on the plotter in use. The SLOW pen speed is 10 cm/s for plotting with marginal pens or transparencies. This softkey is a toggle selection. To modify this parameter, press the **PLOT** hardkey, and then the CONFIG PLOT softkey. The current setting of PEN SPEED appears bright. To change to the other selection of pen speed, press the PEN SPEED softkey once.

DEFAULT SETUP is a softkey that resets the plot parameters to their default parameters:

```
TRACE 1 LINETYPE =7  
TRACE 2 LINETYPE =7  
TRACE 1 PEN NUMBER =1  
TRACE 2 PEN NUMBER =2  
GRATICULE PEN NUMBER =2  
PEN SPEED = FST
```

RETURN is a softkey that changes the menu listing back to the **PLOT** menu. This allows the user to plot after reconfiguration. The same thing is accomplished by pressing the **PLOT** hardkey.

Recall Instrument State

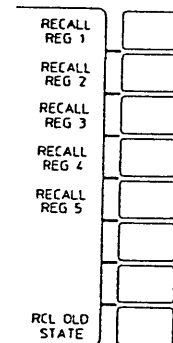
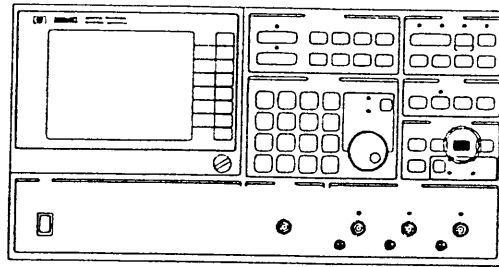

Figure 4-37.

RECALL is a hardkey in the INSTRUMENT STATE section of the front panel used to recall 5 SAVED states or the state of the HP 3577A when it was last turned off (RCL OLD STATE).

To use this feature:

1. Press the **RECALL** hardkey to display the menu
2. Press the softkey corresponding to the instrument state you wish to recall

If **SAVE** and **RECALL** hardkeys are held down when power is turned on, a special test of all main processor non-volatile memory is run that is not part of the regular power-on test. These two keys must be held down until the test messages begin appearing on the screen. One message should be "TOTAL RAM TEST. NON-VOLATILE MEMORY LOST." This test erases all main processor memory resetting INSTRUMENT STATE, PLOT parameters, and the HP-IB to default parameters and trace data stored in D1 through D4. For the HP-IB this means that TALK ONLY is **OFF** and the bus address is 11. This test may be used if the HP 3577A won't respond to key presses and INSTRUMENT PRESET and cycling power has not cleared the problem.

Receiver

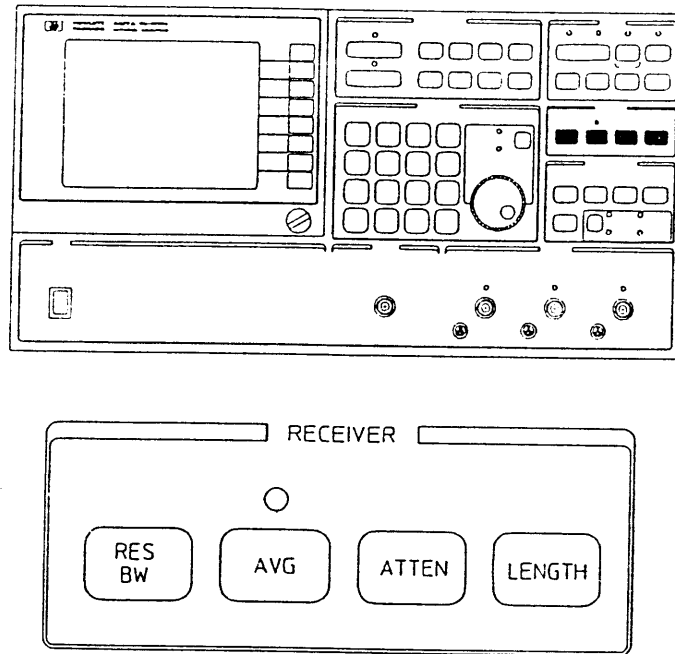

Figure 4-38.

The **RECEIVER** section is one of five front panel sections. This section has four hardkeys which allow the user to control resolution bandwidth, vector averaging, attenuation, impedance, and length for each of the three receiver inputs. For more information on the individual hardkey, refer to the item of interest.

Resolution Bandwidth

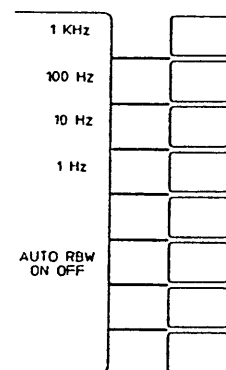
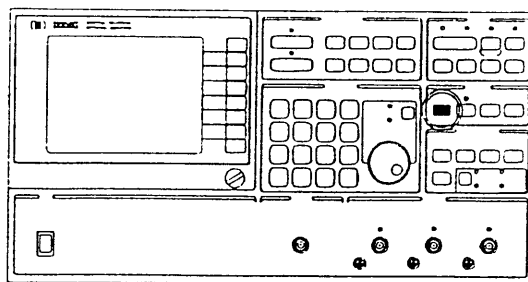

Figure 4-39.

RESOLUTION BANDWIDTH is a hardkey in the RECEIVER front panel section used to display the menu of softkeys shown above. These softkeys may be used to select one of four resolution bandwidths for the receiver IF.

The top four softkey labels in this list are the only valid selections for resolution bandwidth. No data entry is appropriate. Narrow bandwidths usually require more sweep time for accurate measurements. For more on optimizing sweep time for a given bandwidth, refer to "Optimizing Sweep Time" in Appendix A.

AUTOMATIC RESOLUTION BANDWIDTH ON/OFF is a fifth softkey in the RES BW menu when the SWEEP TYPE is LOG FREQ. AUTO RBW is a feature that cycles up through the lower values of resolution bandwidth as the band is swept until it reaches the active (bright) RES BW. This prevents LO feedthrough at low frequencies and allows fast, accurate measurements at high frequencies. With default parameters (sweeping 50 Hz to 200 MHz and RES BW = 1 kHz) the sweep starts at 50 Hz with a resolution bandwidth of 10 Hz. At 400 Hz the bandwidth changes to 100 Hz and at 4 kHz the bandwidth changes to 1 kHz. If FULL SWEEP is selected from the FREQ menu (or if START FREQ is changed to 5 Hz) AUTO RBW starts by waiting approximately 4 seconds for the source to settle. Then the sweep begins at 5 Hz with 1 Hz BW and changes to 10 Hz BW at 40 Hz. The cycle continues as described previously.

Reference
Resolution Bandwidth

When the **SWEEP TYPE** is **ALTERNATE**, the user may select a different resolution bandwidth for each of the two traces. This is in addition to being able to select different band sweeps, sweep times, and source amplitudes for each trace.

Each of the four resolution bandwidths has a settling time associated with it. Settling time is the time the source stays at the start frequency (or amplitude) before beginning a sweep. The following table lists the default values of settling time. Values other than these may be entered only through the use of the HP-IB and a computer controller. For more information on entering new values for settling time refer to the section on remote operation.

Res BW	Settling time
1 kHz	22 ms
100 HZ	55 ms
10 Hz	370 ms
1 Hz	3.707 s

S-Parameter Test Set

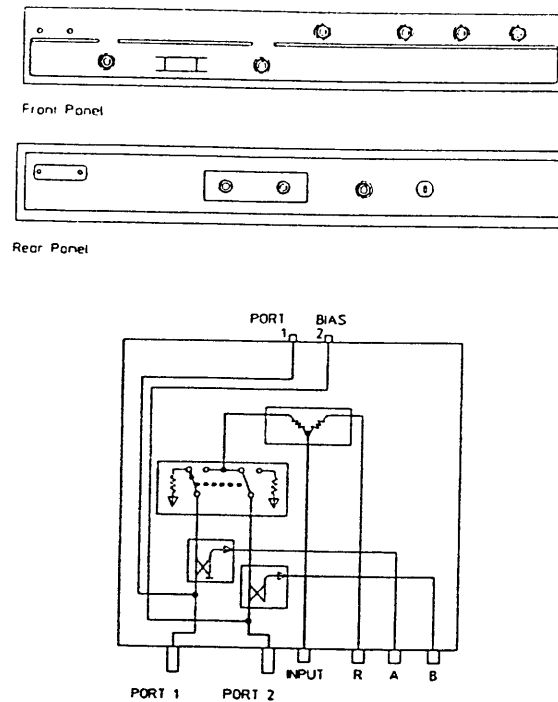

Figure 4-40.

The HP 35677A/B is an S-parameter test set built for use with the HP 3577A Network Analyzer. The A model has 50 Ω ports and the B model has 75 Ω ports. Frequency response for the test set is from 100 kHz to 200 MHz. For complete specifications see the General Information section.

The test set has no internal power supply or HP-IB interface; it is powered and controlled by the HP 3577A. The two are connected together by an interconnection cable between the two instruments' rear panels and by four RF cables between the front panels. The rear panel cable supplies power and ground, control of the test set's coaxial switch and a sense line to indicate when the test set is connected to the analyzer (this changes the **INPUT** menu).

When the HP 35677A/B S-parameter test set is connected to the HP 3577A Network Analyzer the **INPUT** menu consists of S-parameters S11, S21, S12, and S22. These are defined in terms of receiver inputs and test set direction in figure 2-29. Changing the test set direction effectively switches the signal source and termination of the device under test as though it were removed and reconnected to the test set in the reverse direction.

Different S-parameters may be selected for each of the two traces. If this requires the test set to be configured in both directions at the same time, ALTERNATE SWEEP TYPE must be used. In ALTERNATE SWEEP each sweep updates one of the traces and then reconfigures the test set and sweeps the other trace. This switches the test set's relay between sweeps. After five minutes operation in this manner, the HP 3577A times out, changes to single sweep mode to limit wear on the test set relay. The user may change the sweep mode back to continuous for another five minutes of operation or make single sweeps by pressing the TRIG/RESET hardkey.

If alternate sweep is not used and the input of a trace is changed such that the test set must change directions, the other trace input is redefined also, since the test set can't be configured in both directions at the same time.

The direction of the S-parameter test set may be controlled directly by the user if a user defined input is being specified. This may be done in the following manner:

1. Press the **INPUT** hardkey to display the menu
2. Press the **USER DEF INPUT** softkey
3. Enter the input equation as described under the **INPUT** listing found earlier in this section.
4. Note the new softkey label that appears at the bottom of the menu **TEST SET FWD/REV**. This is a push-push toggle type key that directly controls the direction configuration of the test set. The change in configuration does not occur until the end of a sweep.

The **ONE PORT** calibration softkeys (**PARTIAL** and **FULL CAL**) found in the **MEASR CAL** menu are meant to be used with the HP 35677A/B S-parameter test set or a similar configuration of power splitter and directional bridge.

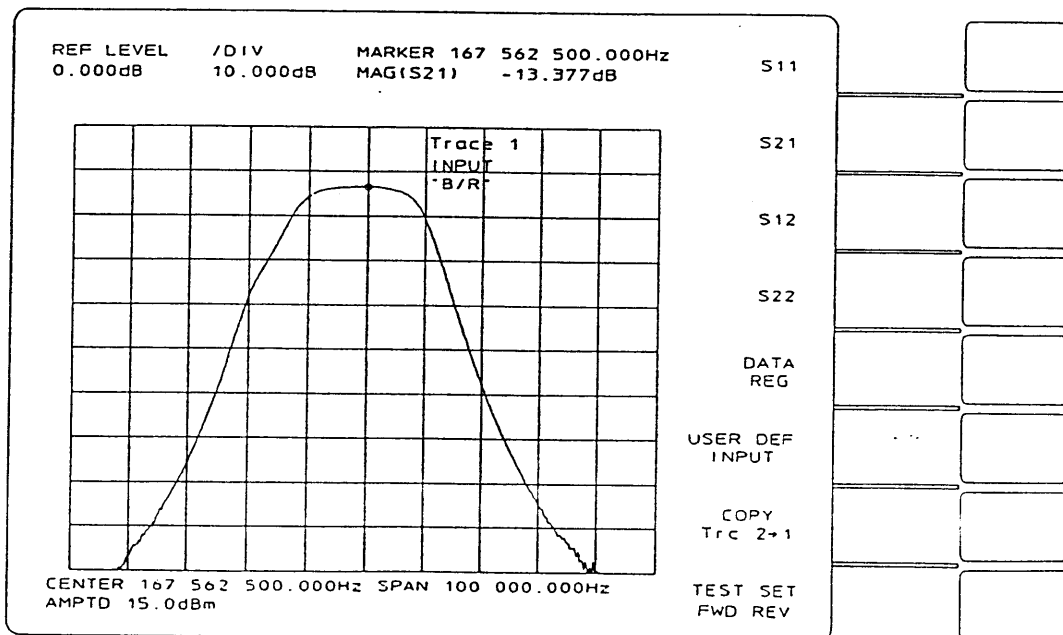

Figure 4-41.

Save Instrument State

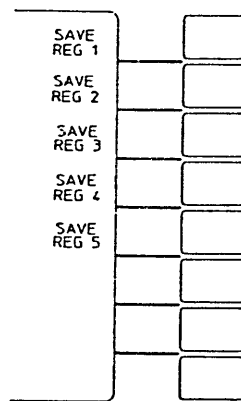
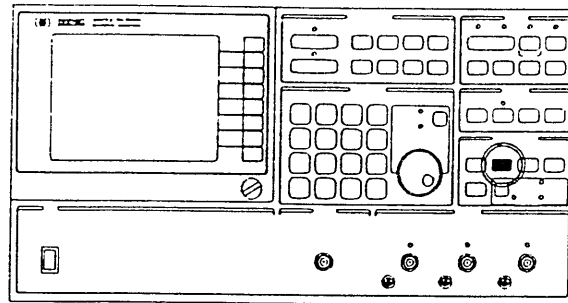

Figure 4-42

SAVE is a hardkey in the **INSTRUMENT STATE** section of the front panel used to display the menu of softkeys shown above. These softkeys may be used to save 5 instrument states. An instrument state is the total set of instrument parameters. This feature is convenient for saving a complex and/or often-used test configuration and **RECALL**ing it for use at a later time.

To use this feature:

1. Press the **SAVE** hardkey to display the menu
2. Press the softkey corresponding to the register in which you wish to save the current instrument state

If **SAVE** and **RECALL** hardkeys are held down when power is turned on, a special test of all main processor non-volatile memory is run that is not part of the regular power-on test. These two keys must be held down until the test messages begin appearing on the screen. One message should be "TOTAL RAM TEST-NON-VOLATILE MEMORY LOST." This test erases all main processor memory resetting instrument state, plot parameters, and the HP-IB to default parameters and trace data in registers D1 through D4. For the HP-IB this means that TALK ONLY is **OFF** and the bus address is 11. This test may be used if the HP 3577A won't respond to key presses and **INSTRUMENT PRESET** and cycling power have not cleared the problem.

Scale

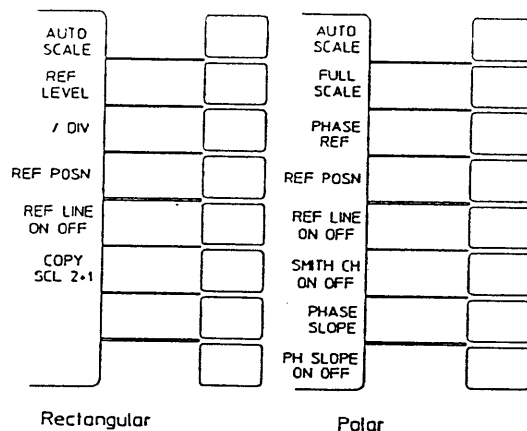
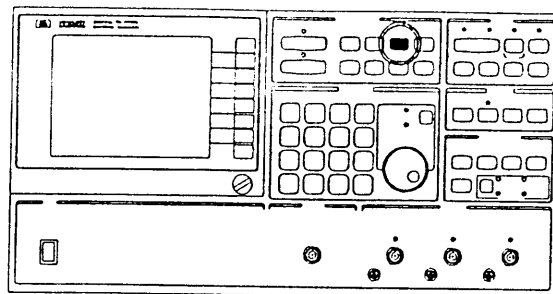

Figure 4-43.

SCALE is a hardkey in the DISPLAY FORMAT section of the front panel used to display the menus of softkeys shown in figure 4-43. These softkeys may be used to modify the vertical axis scale and value of the reference line. None of the **SCALE** features require a new measurement sweep when their values change (unless in ALTERNATE SWEEP). Each uses data stored in trace memory to reconfigure the screen.

REFERENCE LEVEL is a softkey used to enter the value the dashed reference line represents. The default values for REFERENCE LEVEL are 0 dBm without and 0 dB with the test set. The reference level value is valid and active even when the reference line has been turned off.

To change the value of REFERENCE LEVEL:

1. Press the **SCALE** hardkey to display the menu
2. Press the REF LEVEL softkey (if label is not bright)
3. Modify the value with the knob or arrow keys

OR

4. Enter a new value with the numeric key pad
Select units from the menu (press a softkey)

/DIV is a softkey used to enter a value for the vertical scale. The value of **/DIV** may be changed in the same manner as shown for **REFERENCE LEVEL**.

REFERENCE POSITION is a softkey used to enter a value that moves the dashed line to a different height on the graticule. For **LOG MAG** the default position is the top of the graticule, or 100%. **PHASE REFERENCE POSITION** is 50%, **LIN MAG REF POS** is 0% (the bottom of the graticule). The value of **REF POS** may be changed in the same manner as shown for **REFERENCE LEVEL**.

REFERENCE LINE ON/OFF is a softkey used to turn the dashed reference line off and back on. To use this feature, press the **SCALE** hardkey, and then the **REF LINE ON/OFF** softkey. This is a push-push toggle type key function. Each time the softkey is pressed the softkey label changes from **OFF** to **ON** or **ON** to **OFF**. The current status of the feature is indicated by the relative brightness of the **ON** or **OFF** in the label.

COPY SCALE is a softkey used to copy the **SCALE** parameters **REF LEVEL**, and **/DIV** of the inactive trace into the active trace. The softkey label varies depending on which trace is selected. If trace 1 is selected it reads **COPY SCALE 2 → 1**; if trace 2 is selected it reads **COPY SCALE 1 → 2**.

AUTO SCALE is a softkey used to quickly scale the trace so that it fills the graticule without clipping the trace. To use this feature, press the **SCALE** hardkey and then the **AUTO SCALE** softkey.

PHASE SLOPE is a softkey that appears in the menu when the display function is **PHASE** or a function of phase (like delay). This softkey is used to add or subtract a phase shift term to the defined input. **PHASE SLOPE** units are degrees/**SPAN** or radians/**SPAN**. This is somewhat like the **LENGTH** for use with a trace instead of individual receiver inputs and may be used as a phase flattener. Note that changes in frequency span require modification of **PHASE SLOPE** if it is to have the same effect on the new span. The value of **PHASE SLOPE** may be changed in the same manner as shown for **REFERENCE LEVEL**.

One important difference between **LENGTH** and **PHASE SLOPE** is that **LENGTH** values are used to process incoming data when a measurement is being taken and affects values stored in trace memory. **PHASE SLOPE** processing uses data stored in trace memory to create a new trace for the screen and so does not affect stored data or require a measurement sweep when new **PHASE SLOPE** values are entered.

Reference
Scale

PHASE SLOPE ON/OFF is a softkey used to turn the phase slope feature off and back on. This is a push-push toggle type softkey. Turning the feature off has the same effect on the measurement as if a value of 0 deg/SPAN was entered for PHASE SLOPE.

FULL SCALE is a softkey used to change the value of magnitude represented by the outer ring of the polar graticule. If the display function is POLAR, the menu shown when the hardkey **SCALE** is pressed contains FULL SCALE instead of REF LEVEL. To change the value of FULL SCALE:

1. Press the **SCALE** hardkey to display the menu
2. Press the FULL SCALE softkey (if label is not bright)
3. Modify the value with the knob or arrow keys

OR

4. Enter a new value with the numeric key pad
Select units from the menu (press a softkey)

PHASE REFERENCE is a softkey used to change the value of phase represented by the dashed line that exists between the center and outer ring of the graticule. Changing the PHASE REFERENCE has the effect of rotating the trace. The value of PHASE REF may be changed in the same manner as shown for REFERENCE LEVEL.

REFERENCE POSITION is a softkey used to reposition the dashed reference line on the polar graticule. Changing the REF POS has the effect of rotating the trace and reference line. The value of REF POS may be changed in the same manner as shown for REFERENCE LEVEL.

REFERENCE LINE ON/OFF is a softkey used to turn the dashed reference line off and back on. This is a push-push toggle type key. Turning the reference line off does not change the effect of reference position (i.e. a change in the REF POS value rotates the trace even if the reference line does not appear).

SMITH CHART ON/OFF is a softkey that allows the user to overlay the polar graticule with a Smith chart. This is a push-push toggle type key. The Smith chart is used to graphically convert reflection coefficient to normalized impedance. The marker information reads impedance when the Smith chart is on.

To use this feature, the input definition should be S11 (A/R) or S22 (B/R) and the full scale value should be 1.0. If full scale is a value other than 1.0, the trace values cannot be read directly from the Smith chart but the marker information is still valid. Note that the marker units may be toggled between magnitude & phase and real & imaginary by pressing the MARKER M,P R,I softkey in the MKR menu.

Screen

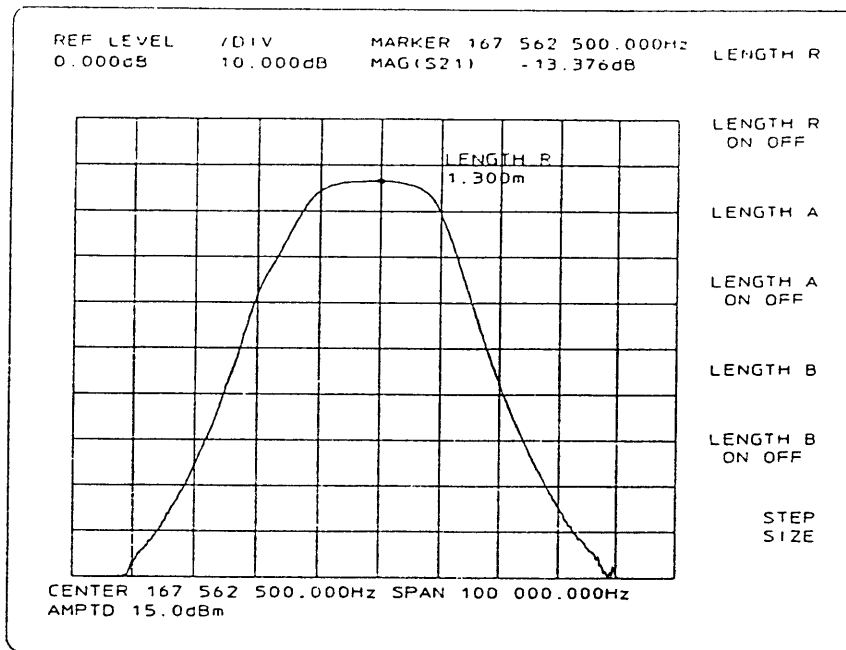
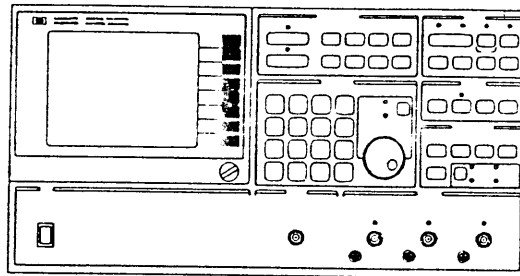

Figure 4-44.

The **SCREEN** is the total CRT display area. It is composed of the graticule, which takes up most of the screen in the center, the menu area (down the right side from top to bottom), and the alphanumeric characters which appear above and below the graticule. See figure 4-44.

Softkey

The eight keys with no stenciling next to the menu area of the screen are called SOFTKEYS. The lettered keys are referred to as hardkeys. Most hardkeys only function is to display a menu of softkey labels. Exceptions are the keys in the DATA ENTRY section of the front panel and the **INSTR PRESET**, **LCL**, **TRACE 1** and **TRACE 2**, and **TRIG/RESET** hardkeys. See figure 4-45.



Softkeys



Figure 4-45.

Source

The **SOURCE** section of the front panel contains the hardkeys that display menus of softkeys which control the parameters of the source. These parameters include **SWEEP TYPE** (linear, alternate, log, amplitude, or CW), **SWEEP MODE** (continuous, single, or manual), **SWEEP TIME**, **FREQUENCY**, **AMPLITUDE**, **TRIGGER MODE** (free run, line, and external), and **TRIGGER/RESET**. For more information on individual functions refer to the hardkey of interest.

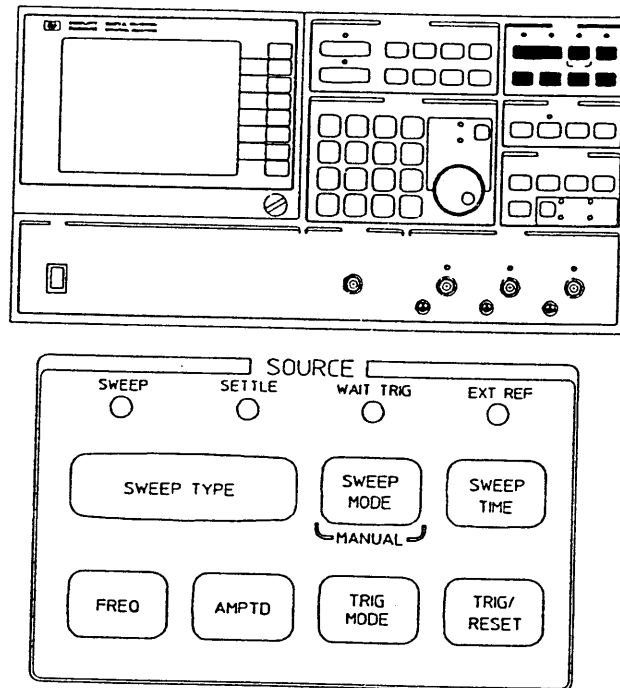

Figure 4-46.

Special Functions

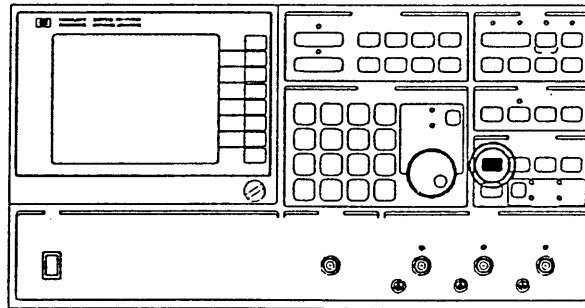
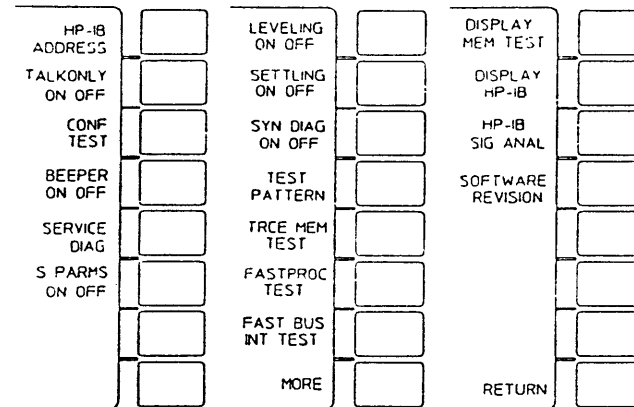

Figure 4-47.

The **SPECIAL FUNCTIONS** hardkey in the INSTRUMENT STATE front panel section contains the softkey menus for viewing and modifying the HP-IB address, running a confidence test, turning the beeper on or off, and many service diagnostics.

HP-IB ADDRESS is a softkey used to view and change the address of the HP 3577A on the Hewlett-Packard Interface Bus. This address is set at the factory to 11 and may be set to any whole number from 0 to 30, inclusive. INSTR PRESET does not change this value, nor does cycling power. This number cannot be changed via the HP-IB; it can only be changed manually. To modify the HP-IB address:

1. Press the **SPCL FCTN** hardkey to display the first menu
2. Press the **HP-IB ADDRESS** softkey
3. Enter the new address with the numeric key pad
4. Press the **ENTER** softkey

TALK ONLY ON/OFF is a push-push toggle type softkey that changes the HP-IB configuration to TALK ONLY (ON) for driving a plotter. TALK ONLY should be turned OFF when the HP 3577A is controlled via HP-IB.

CONFIDENCE TEST is used to check each receiver channel for general pass/fail status. A screen message requests the user to put a cable between the source output and the receiver to be tested. Nine tests are run and the status of each (pass/fail) is displayed on the screen as the results are determined. Any test that fails, stops the test and highlights the screen message specifying the failure. The test may be continued from a failed test by pressing the softkey "CONTINUE TEST." The S-parameter test set should not be connected to the receiver being tested during the CONFIDENCE TEST. In the case of a test failure, refer the problem to a service repair facility.

BEEPER ON/OFF is a push-push toggle type softkey used to turn the beeper off and back on. This is not reset by **INSTR PRESET**.

S PARMS ON/OFF is a softkey used to change the **INPUT** definition menu between the S-parameters menu to the standard input menu.

SERVICE DIAGNOSTICS is a softkey which displays a menu used for diagnosing service problems with the HP 3577A. The menu items that follow are described briefly. For more details on these features and their uses refer to the HP 3577A Service Manual.

LEVELING ON/OFF is a softkey that disables the source leveling loop when OFF. This is used for service of the HP 3577A and should not be changed by an operator. This feature is reset to ON by **INSTR PRESET** or power on.

SETTLING ON/OFF is a softkey that turns the digital filter settling on (default condition) or off. This is used for service of the HP 3577A and should not be changed by an operator. This feature is reset to ON by **INSTR PRESET** or power-on.

SYNTHESIZER DIAGNOSTICS ON/OFF is a softkey used to turn on the fractional N synthesizer diagnostics for service of the HP 3577A and should not be changed by an operator. This feature's status is reset to OFF by **INSTR PRESET** or power-on.

TEST PATTERN is a softkey that turns on the digital display test pattern. This feature is used for alignment of the screen area of the HP 3577A. To terminate the test pattern and return to the measurement state press the **INSTR PRESET** hardkey.

TRACE MEMORY TEST is a softkey that tests the RAM in trace memory when pressed. This test takes approximately 20 seconds to run during which time all other activity is suspended. This test may be interrupted by pressing **INSTR PRESET**.

Note



This test clears all information stored in trace memory including D1, D2, D3, D4, R, A and B.

FAST PROCESSOR TEST is a softkey that runs a test on the fast processor board. This test should immediately display the message "FP SELF TEST PASSED."

FAST BUS INTERFACE TEST is a softkey that tests the port between the main processor and the fast processor. This test should immediately display the message "MP/FP PORT TEST PASSED."

DISPLAY MEMORY TEST is a softkey that tests the memory of the digital display unit. This test takes approximately 5 seconds to run, during which time the display is blank. The HP 3577A returns from the test in the preset condition.

DISPLAY HP-IB is a softkey that puts a picture of the HP-IB connector on the screen. Pin numbers and signal names are labeled on the figure and a bright dot appears on any pin that has a TRUE (low) signal state on it. This feature allows the user to display the status of the HP-IB lines of the HP 3577A.

HP-IB SIGNATURE ANALYSIS is a softkey that runs a program to allow signature analysis tests to be run on the HP 3577A's HP-IB section.

SOFTWARE REVISION is a softkey used to display a screen message which shows the revision status of the operating system.

Store Data

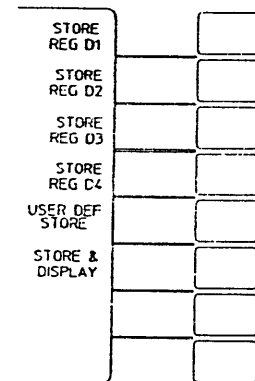
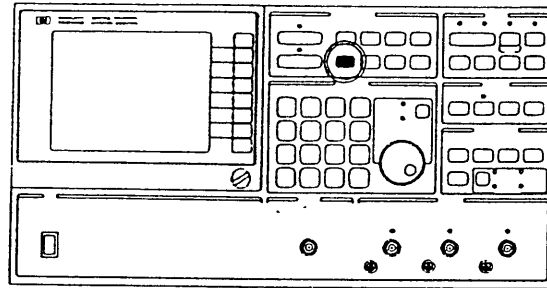

Figure 4-48.

STORE DATA is a hardkey in the DISPLAY FORMAT front panel section used to display the menu of softkeys shown above. These softkeys may be used to store a trace as it's specified by the **INPUT** definition, store a trace defined by the user, or store and compare. The trace stored is independent of the active display function. The data stored is complex trace data identical to what is stored in trace memory registers R, A, and B when a measurement is taken.

The HP 3577A does not "remember" the instrument state (such as **INPUT** definition or start and stop frequencies) active when the data was stored. If the stored information is used in a user defined equation, care should be taken that the parameters of all terms are compatible. For example, for a user defined **INPUT** of R/D1 (where D1 is data register one), R and D1 should both have the same start and stop frequencies, amplitude, and sweep type. The user may **SAVE** instrument state at the same time that data is **STORED** to be able to recall the state used to store data.

To use this feature:

1. Press the **STORE DATA** hardkey to display the menu
2. Press the softkey corresponding to the register you wish the active trace to be stored in

USER DEFINED STORE is a softkey used to define a function and have the results stored in the register of choice. This equation is constructed in the same manner as done for user defined functions and user defined inputs. When selected, the menu changes to the first term selection menu. Terms include five user defined functions, four data registers, three user defined complex constants, and the three receiver inputs: R, A, and B. After the first term is selected, a new menu is displayed containing the four possible math functions (+, -, *, and /) and the **STORE IN REGISTER D_** command. These two menus alternate until you finish the definition and use the **D_** command to select the register to store into. This store occurs without affecting the trace on the screen unless the active **INPUT** definition is a function of the register stored to.

STORE & DISPLAY is a softkey used to store the currently selected trace and compare the stored data with measurement data using one key press. The storage register used for the **STORE** depends on the active trace. If **TRACE 1** is active, data is stored in data register **D3**; if trace two is active then data is stored in **D4**. After the **STORE**, the **INPUT** definition of the inactive trace is changed to display the data just stored. If **TRACE 1** is active the store goes into **D3** and the **INPUT** definition of **TRACE 2** becomes **D3**. If **TRACE 2** is active when **STORE & DISPLAY** is pressed the store goes into **D4** and the **INPUT** of **TRACE 1** becomes **D4**.

Note



Because this feature writes to a data register, information stored there is overwritten and lost.

Sweep Mode

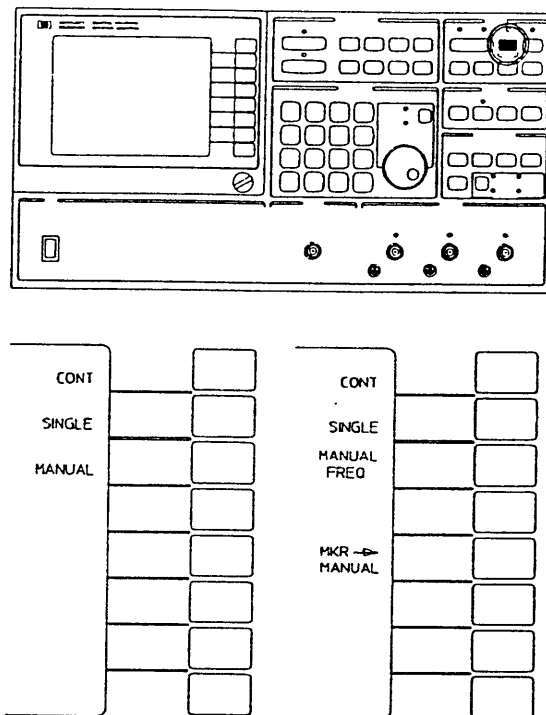

Figure 4-49.

SWEEP MODE is a hardkey in the SOURCE section used to display the menus of softkeys. These softkeys may be used to select CONTINUOUS, SINGLE, or MANUAL sweeps. The default selection is CONTINUOUS.

CONTINUOUS is a softkey that selects a sweep mode which starts a new sweep after each sweep completion. The **TRIG/RESET** hardkey resets the sweep in progress; after which settling takes place and the next sweep begins. For more information on settling time, refer to RESOLUTION BANDWIDTH.

SINGLE is a softkey that selects a sweep mode which sweeps once each time the HP 3577A is triggered. To use this feature press **SWP MODE** hardkey, and then the SINGLE softkey. The sweep in progress continues but no new sweep begins when the current sweep ends. The WAIT TRIG LED illuminates until the **TRIG/RESET** hardkey is pressed to start a new sweep. The **TRIG/RESET** hardkey may also be used to stop a sweep in SINGLE SWEEP MODE.

Settling is done for the next sweep immediately upon completion of the present sweep. Thus the sweep begins without delay on the next **TRIG/RESET** key press if the SETTLE LED is dark.

Reference
Sweep Mode

MANUAL is a softkey used to sweep the display manually using the knob or the arrow keys. To use this feature:

1. Press the **SWEEP MODE** hardkey to display the menu
2. Press the **MANUAL** softkey. The label changes to **MANUAL FREQ** and the new label **MKR → MANUAL** appears in the menu. Also the marker in the marker information block changes to **MANUAL**.
3. Move the marker using the knob (in **MARKER** mode) to the point of interest on the trace
4. Press the **MKR → MANUAL** softkey. The sweep dot moves to the marker position and the marker information block shows the measurement being made.
5. Modify the frequency value with the knob (in **ENTRY** mode) or arrow keys. If the knob is used in **ENTRY** mode the marker moves to the sweep dot when the knob is first rotated.

OR

6. Enter a new value with the numeric key pad
Select units from the menu (press a softkey)

MANUAL SWEEP allows the user to make measurements at frequencies that would not be sampled in an automatic sweep of the same span. Any frequency from 0 to 200 MHz may be entered, to the nearest mHz, with the numeric keypad. If the offset marker is on in manual sweep the marker information block displays **OFS MN** instead of **MANUAL**, **MARKER**, or **OFFSET**.

Sweep Time

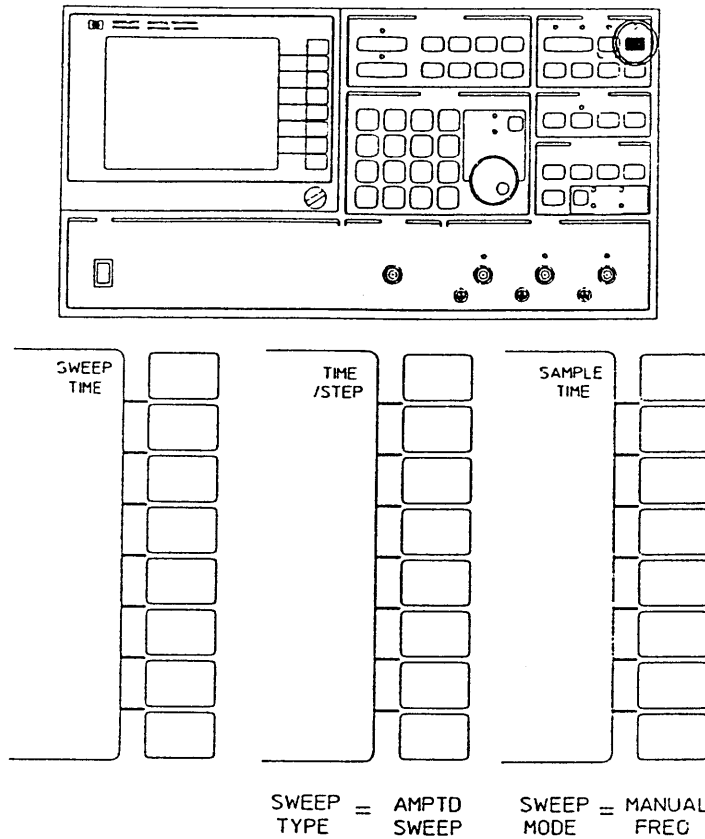

Figure 4-50.

SWEEP TIME is a hardkey in the SOURCE section of the front panel used to select measurement times. Immediately after power-on or **INSTRUMENT PRESET**, the sweep time for a linear frequency sweep is 1 second. If the **SWEEP TYPE** is changed to AMPTD SWEEP the default TIME/STEP is 0.050 seconds and the total sweep time depends upon the STEPS/SWEEP (found in the **AMPTD** menu). If the SWEEP MODE is changed to MANUAL, the default SAMPLE TIME is 0.050 seconds. In a frequency sweep, the sweep dot appears if the sweep time is 1 second or more.

Reference
Sweep Time

In an amplitude sweep the sweep dot appears if the time/step is 0.010 seconds or more. When the sweep type is ALTERNATE SWEEP, different sweep times may be selected for each of two traces. For more information see ALTERNATE SWEEP listed under SWEEP TYPE. When the sweep type is LOG SWEEP, the sweep time may appear to be greater than the value entered for sweep time, due to overhead time. The device under test is swept at an effective rate equal to the value of sweep time.

To change the value of **SWEEP TIME**:

1. Press the **SWEEP TIME** hardkey
2. Modify the value with the knob or the arrow keys

OR

3. Enter a new value with the numeric keypad
Select units from the menu (press a softkey)

Sweep time may be limited by the math processing load. When this occurs, the screen message "SWEEP TIME INCREASED" appears and the sweep time increases automatically. Refer to Appendix A for more information on HP 3577A data processing and sweep time optimization.

Sweep Type

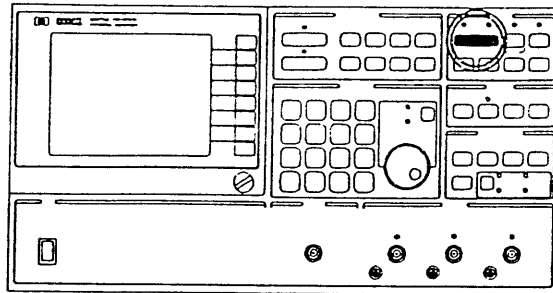

LIN FREQ SWEEP	<input type="checkbox"/>
ALTERNTE SWEEP	<input type="checkbox"/>
LOG FREQ SWEEP	<input type="checkbox"/>
AMPTD SWEEP	<input type="checkbox"/>
CW	<input type="checkbox"/>
SWP DIR UP DOWN	<input type="checkbox"/>
	<input type="checkbox"/>

Figure 4-51.

SWEEP TYPE is a large hardkey in the **SOURCE** section of the front panel used to display the menu of softkeys shown above. These softkeys may be used to select from five sweep types.

Note



Changing sweep type or sweep resolution (in the **FREQ** menu) erases registers R, A, and B in trace memory (sets all zeros).

LINEAR FREQUENCY SWEEP is the default sweep type. The graticule displayed on the screen has ten equal divisions. This softkey is a mode select type of key; data entry is not appropriate.

Reference
Sweep Type

ALTERNATE SWEEP is a softkey used to assign separate **FREQ**, **AMPTD**, **RES BW** and **SWP TIME** parameters for each trace. The sweeps are linear and alternate. Without using **ALTERNATE SWEEP** the user may define different display functions, inputs, and scales for each trace. With **ALTERNATE SWEEP** each trace may also have different frequency parameters (start/stop, center, span), source amplitudes, resolution bandwidths, and sweep times.

When the sweep type is alternate, stores are not allowed. This means that none of the **MEAS CAL** features may be used in alternate sweep. Averaging is turned off when alternate sweep is active. If two amplitude values selected cause the output relays to switch as the sweeps alternate, the HP 3577A times out after five minutes. Also, if the inputs selected for the two traces cause the S-parameter test set to switch configuration from forward to reverse, time out occurs after five minutes. Time out changes sweep mode to single, changes the menu to **SWP MODE** and the **WAIT TRIG LED** illuminates. The user may trigger single sweeps with the **TRIG/RESET** key or change the sweep mode back to continuous for another five minutes of uninterrupted operation. Time out extends the life of the HP 3577A and HP 35677A/B relays.

To use this feature:

1. Set up trace 1 parameters (input, display function, frequency, source amplitude, scale, sweep time, and resolution bandwidth).
2. Turn on trace 2 by pressing hardkeys **TRACE 2**, **DSPLY FCTN**, and selecting any menu item (use of **POLAR** turns trace 1 off). Trace 2 turns on having the same start/stop frequencies, amplitude, bandwidth and sweep time as trace 1 and both traces are swept simultaneously.
3. Press **SWEEP TYPE** hardkey, and **ALTERNATE SWEEP** softkey. Trace 2 parameters revert to their previous settings (if the HP 3577A was just preset, these are the default parameters). This allows the alternate sweep trace to be turned off and back on without losing trace parameters.
4. Enter the new parameters for trace 2.

LOG FREQ SWEEP is a softkey that selects a log scale for the horizontal axis of the display. The logarithmic graticule has frequency values listed across the bottom of the screen. The graticule changes as the start and stop frequencies are changed. When the ratio of STOP FREQ/START FREQ is less than four, the graticule changes back to a linear scale.

When **LOG FREQ SWEEP** is active the **FREQ** menu contains only **START FREQ**, **STOP FREQ**, and **FULL SWEEP**. There are no **CENTER FREQ**, **FREQ SPAN**, or **SWEEP RESOLUTION** softkeys as in **LIN FREQ SWEEP**. Default Sweep is from 50 Hz to 200 MHz. **FULL SWEEP** is from 5 Hz to 200 MHz.

When **LOG FREQ SWEEP** is active the **RES BW** menu has an added item called **AUTO RBW** (for automatic resolution bandwidth) which is on. The sweep starts at 50 Hz and stops at 200 MHz and the resolution bandwidth changes during the sweep to reduce LO feedthrough at the lower frequencies. If **FULL SWEEP** is selected, the sweep starts at 5 Hz and the 1 Hz **RES BW** is active from 5 Hz to 40 Hz (4 seconds of settling occurs before the sweep begins). Then the HP 3577A switches to 10 Hz BW until it reaches 400 Hz when it changes to 100 Hz. The last switch is at 4 kHz where it switches to 1 kHz **RES BW**. When **AUTO RBW** is on the **RES BW** selected (bright) is the widest bandwidth the **AUTO RBW** progresses to; if 100 Hz **RES BW** is selected and **AUTO RBW** is on, the HP 3577A does not switch to 1 kHz **RES BW** at 4 kHz as it would if 1 kHz **RES BW** were selected.

Other menus that are changed by selecting **LOG FREQ SWEEP** are:

DISPLAY FUNCTION: no DELAY

MKR → : no MKR→ CENTER freq

SWEEP TYPE: no SWP DIR

AMPTD SWEEP is a softkey label in the **SWEEP TYPE** menu. It is a logarithmic sweep of the source output amplitude. The default start and stop levels are -40 dBm and 0 dBm, respectively. Either start or stop amplitude may be from -49 dBm to +15 dBm and start may be larger or smaller than stop amplitude (unlike frequency sweeps).

If left running, the amplitude sweep times out after five minutes. This is to prolong the life of the relays used to switch pads in the output circuitry in and out. The time out condition switches the **SWEEP MODE** from **CONTINUOUS** to **SINGLE** and displays an error message. The user may trigger single sweeps with the **TRIG/RESET** key or change the sweep mode back to continuous.

CW is a softkey that puts the HP 3577A in a single frequency measurement state. When the **SWEEP TYPE** is **CW** the frequency menu contains only the menu items **FREQ** and **STEP SIZE**. The display shows a single line from the bottom of the graticule to the height of the signal level at the specified frequency. Any frequency may be entered with the numeric key pad with millihertz resolution. Group delay is not available on the **DISPLAY FUNCTION** menu when **CW** is selected.

Reference
Sweep Type

SWEEP DIRECTION UP/DOWN is a push-push toggle type softkey that allows the user to change the direction of the sweep. The default direction is UP, or left to right. In frequency sweeps left to right is always up because the start frequency cannot be larger than the stop frequency. In an amplitude sweep the start amplitude may be larger than stop amplitude, so amplitude may be swept from a higher to lower value without changing the SWEEP DIRECTION. Changing sweep direction to DOWN in an amplitude sweep causes the sweep dot to move from right to left.

Changing sweep direction during a frequency sweep is useful for determining whether the sweep time is large enough for the selected resolution bandwidth. If you change the sweep direction while the sweep dot is on a steep part of the response and the dot does not exactly retrace its path, the sweep time should be increased. See Optimizing Sweep Time in Appendix A. The SWEEP DIRECTION selection is not offered in the CW sweep or log free sweep type.

Trace 2

Trace 1
Trace 2

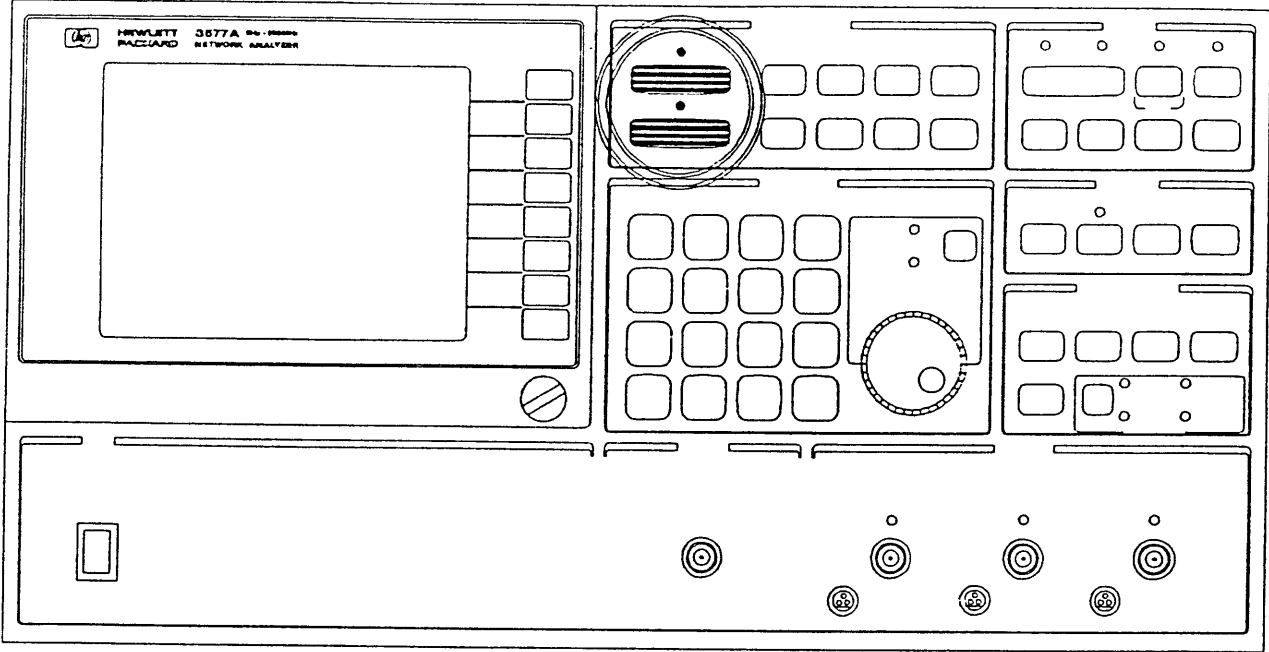

Figure 4-52.

TRACE 1 and **TRACE 2** are two hardkeys in the **DISPLAY FORMAT** front panel section that are used to select the active trace. The active trace is indicated by the illuminated LED over either the **TRACE 1** or **TRACE 2** key and by a bright trace and marker information block on the screen. Hardkeys in the **DISPLAY FORMAT** front panel section are used for data entry or mode selection for one of the two traces. If **SWEEP TYPE** is **ALTERNATE SWEEP** (in the **SOURCE** section) then **FREQ**, **AMPTD**, **SWP TIME**, and **RES BW** data is also trace dependent. For these hardkeys, the data entered or mode selected affects only the selected trace.

When the HP 3577A is preset or turned on, trace one is **LOG MAGNITUDE** and active and trace two is off. To turn on trace 2, press **TRACE 2** hardkey, **DSPLY FCTN** hardkey), and press one of the softkeys other than **OFF**. Trace two and characters related to it (**REF**, **/DIV**, and marker information) appear brighter than trace one when the **TRACE 2** LED is illuminated.

Trigger Mode

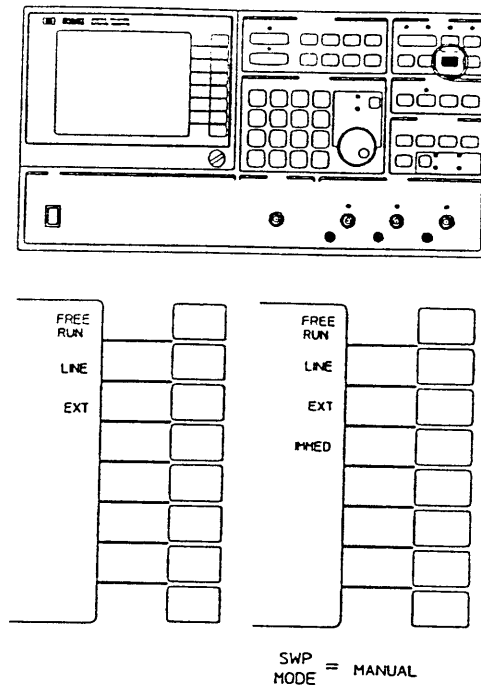

Figure 4-53.

TRIGGER MODE is a hardkey in the SOURCE section of the front panel used to display the menu of softkeys shown above. These softkeys may be used to select the type of triggering used by the HP 3577A to initiate measurement sweeps.

FREE RUN is a softkey that is the default trigger mode selection. In FREE RUN the HP 3577A triggers a new sweep as soon as the previous sweep ends and the source settles (settling is indicated by an LED in the SOURCE section). If the **SWEEP MODE** is SINGLE, the next sweep does not begin until the user presses the **TRIG/RESET** hardkey.

LINE is a softkey that selects the power line as the trigger source. This results in the power line starting the sweep after the settling is complete. If **SWEEP MODE** is SINGLE the next sweep does not begin until the user presses the **TRIG RESET** hardkey and the line trigger occurs.

EXTERNAL is a softkey used to select the external trigger input on the back panel as the trigger source. The trigger occurs after settling is complete and (if **SWEEP MODE = SINGLE**) the **TRIGGER/RESET** hardkey is pressed. The HP 3577A triggers a sweep on the high-to-low transition of a TTL logic signal or a switch closure to ground. When the HP 3577A is ready to be triggered the **WAIT TRIG LED** in the **SOURCE** section of the front panel is illuminated. If a trigger signal occurs when the **WAIT TRIG LED** is not illuminated the trigger is ignored. Each trigger requires a transition (edge) of the external trigger signal so the trigger signal must return to the pre-trigger state before triggering again; holding a closure to ground or low signal on the external trigger input does not continue triggering the HP 3577A. There is a delay of 250 to 500 microseconds from the time the trigger signal is received to the beginning of the sweep.

IMMEDIATE triggering is a softkey that appears in this menu only when the **SWEEP MODE** is **MANUAL**. If this method of triggering is selected, the operator triggers the HP 3577A to take a measurement by pressing the **TRIG/RESET** hardkey. To use this feature:

1. Press the **SWP MODE** hardkey to display a menu
 2. Press the **MANUAL** softkey
 3. Press the **TRIG MODE** hardkey to display a menu
 4. Press the **IMMED** softkey
 5. Press the **SWP MODE** hardkey
 6. Move the marker to the point of interest
 7. Press the **MKR → MANUAL** softkey. The **MANUAL FREQUENCY** changes to that of the marker but no measurement is taken
 8. Press the **TRIG/RESET** hardkey to take the measurement
- OR
9. Enter a new value with the numeric key pad
Select units from the menu (press a softkey)
 10. Press the **TRIG/RESET** hardkey to take the measurement

Trigger/Reset

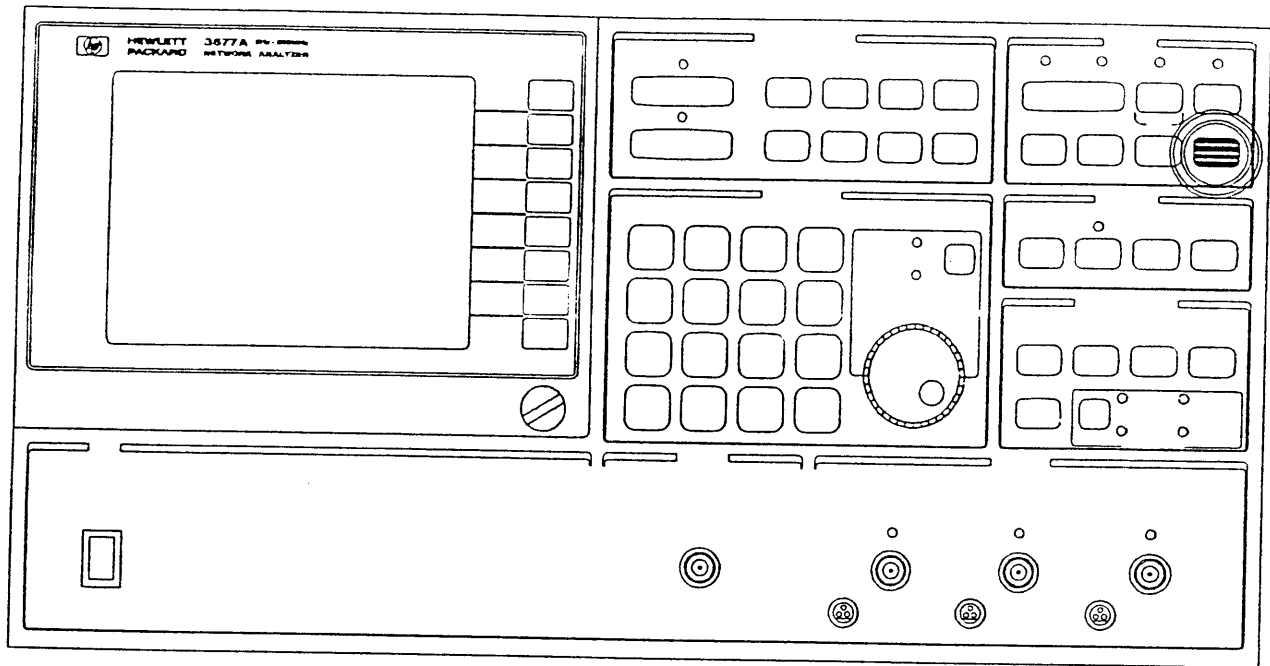

Figure 4-54.

TRIG/RESET is a hardkey in the **SOURCE** section of the front panel that is used by the operator to either **TRIGGER** or **RESET** in preparation for a measurement. This is one of five hardkeys that do not display a menu. It executes its function immediately when pressed.

When the **SWEEP MODE** is **CONTINUOUS**, the **TRIGGER RESET** hardkey stops the current sweep and initiates a new sweep. The new sweep starts as soon as settling is complete.

When the **SWEEP MODE** is **SINGLE**, the **TRIGGER RESET** triggers the measurement, if the **WAIT TRIG LED** is illuminated. If a sweep is in progress, pressing **TRIGGER RESET** resets or stops the sweep, resets to the start frequency (or amplitude if **SWEEP TYPE** is **AMPTD**), and then settles. After settling, the **WAIT TRIG LED** illuminates and pressing **TRIGGER RESET** triggers the HP 3577A.

When the **SWEEP MODE** is **MANUAL** and the **TRIGGER MODE** is **IMMED**, the **TRIGGER RESET** hardkey is used to take each measurement. See **TRIGGER MODE, IMMEDIATE** for more information.

Chapter 5

General Information

General Information

Introduction

This chapter contains instructions for installing and interfacing the HP 3577A Network Analyzer and the HP 35677A/B S-parameter Test Set. Included are initial inspection procedures, power and grounding requirements, operating environment, available accessories and options, installation instructions, HP-IB interfacing procedures, and instructions for repacking and shipment.

Initial Inspection

This instrument was carefully inspected both mechanically and electrically before shipment. It should be free of marks and scratches and in perfect electrical order upon receipt. To confirm this, inspect the instrument for physical damage incurred in transit, inventory the supplied accessories (listed in table 5-2), and test the electrical performance using the Confidence Test listed in the section on Getting Started. If there is physical damage, if the contents are incomplete or if the instrument does not pass the Confidence Test, notify the nearest HP Sales and Service Office. If the shipping container is damaged or the cushioning material shows signs of stress, notify the carrier as well as the Hewlett-Packard office. Keep the shipping material for the carrier's inspection.

Warning



The integrity of the protective earth ground may be interrupted if the HP 3577A is mechanically damaged. Under no circumstance should the HP 3577A be connected to power if it is damaged.

Power Requirements

Caution



Before applying ac line power to the HP 3577A, ensure the voltage selector switch on the back panel of the instrument is set for the proper line voltage and that the correct line fuse is installed in the rear panel fuse holder.

The HP 3577A can be operated from any single phase ac power source supplying:

86V to 127V from 48 Hz to 440 Hz
(115V Voltage Selector setting)

or

195V to 253V from 48 Hz to 66 Hz
(230V Voltage Selector setting)

Power consumption is less than 450 VA.

Power Cable And Grounding Requirements

The HP 3577A is equipped with a three-conductor power cord which, when plugged into an appropriate receptacle, grounds the instrument cabinet. The type of power cable plug shipped with each instrument depends on the country of destination. Refer to figure 5-1 for the part number of the power cable and plug configurations available. If the appropriate power cable is not included with your instrument, contact the nearest HP Sales and Service Office and the proper cable will be provided.

Warning



The power cable plug must be inserted into a socket outlet provided with a protective earth ground terminal. Defeating the protection of the grounded instrument cabinet can subject the operator to lethal voltages.

General Information
Power Cable And Grounding Requirements

<p>United Kingdom Option 900</p>  <p>PLUG*: BS 1363A CABLE*: HP 5041-5807</p> <p>220V-5A OPERATION</p>	<p>Australia/New Zealand Option 901</p>  <p>PLUG*: NZSS 198/AS C112 CABLE*: HP 5041-5808</p> <p>220V-6A OPERATION</p>
<p>Continental Europe Option 902</p>  <p>PLUG*: CEE7-V11 CABLE*: HP 5041-5809</p> <p>220V-6A OPERATION</p>	<p>USA/CAN Option 903</p>  <p>PLUG*: NEMA 5-15P CABLE*: HP 5041-5819</p> <p>125V-10A** OPERATION</p>
<p>USA 250V Option 904</p>  <p>PLUG*: NEMA-G-15P CABLE*: HP 5041-5806</p> <p>250V-5A** OPERATION</p>	<p>Japan Option 918</p>  <p>PLUG*: MITI 41-9692 CABLE*: HP 5041-5840</p> <p>125V-12A OPERATION</p>
<p>Switzerland Option 906</p>  <p>PLUG*: SEV 1011.1959-24507 TYPE 12 CABLE*: HP 5041-5812</p> <p>220V-6A OPERATION</p>	<p>Denmark Option 912</p>  <p>PLUG*: DHCR 107 CABLE*: HP 5041-5814</p> <p>220V-6A OPERATION</p>

Figure 5-1

* The number shown for the plug is the industry identifier for the plug only, the number shown for the cable is an HP part number for a complete cable including the plug.

** UL listed for use in the United States of America.

Operating Environment

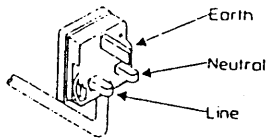
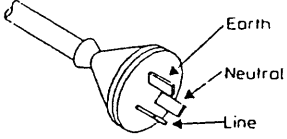
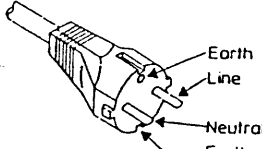
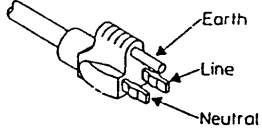
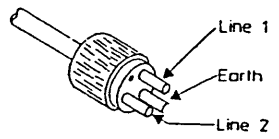
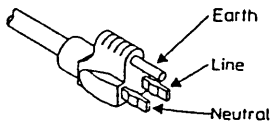
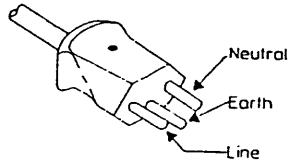
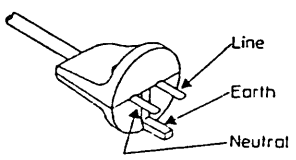
Warning



To prevent potential fire or shock hazard, do not expose the HP 3577A to rain or other excessive moisture.

Temperature The HP 3577A may be operated in temperatures from 0° C to +55° C. The HP 3577A performance specifications apply within this temperature range.

Humidity The instrument may be operated in environments with humidity up to 95%. However, the HP 3577A should be protected from temperature extremes which cause condensation.

Altitude The HP 3577A may be operated at altitudes up to 4,600 meters (15,000 feet).

Cooling System The HP 3577A is equipped with a forced-air cooling system to maintain the proper internal operating temperature. The cooling fan is mounted on the rear panel. Air, drawn through the rear panel fan filter, is circulated through the instrument and exhausted through holes in the side panels. The HP 3577A should be mounted to permit as much air circulation as possible, with at least one inch clearance at the rear and on each side. The filter for the cooling fan should be removed and cleaned at least once every 30 days. To clean the fan filter, flush it with soapy water, rinse, and then air dry.

Thermal Cutout The HP 3577A is equipped with a thermal cutout switch which automatically turns off the main power supply whenever the internal temperature is excessive. The temperature at which this occurs is dependent upon line voltage and airflow. With proper airflow and operating line voltage, thermal cutout does not occur at or below an ambient temperature of +55° C. The switch resets automatically when the instrument is turned off, allowed to cool and turned back on. If a thermal cutout occurs, check for fan stoppage, clogged fan ports, and other conditions that can obstruct airflow or otherwise cause excessive heating.

Note



The thermal cutout will operate at any external temperature above +15° C if the airflow is blocked.

Table 5-1. Accessories Available

MINIMUM CONFIGURATION					
Description	50Ω Impedance		75Ω Impedance		High Impedance
	Transmission	S-Parameters	Transmission	S-Parameters	Transfer functions
Network Analyzer	HP 3577A	HP 3577A	HP 3577A	HP 3577A	HP 3577A
S-Parameter Test Set/Kit		HP 35677A		HP 35677B	
Type N Calibration Kit		HP 35678A		HP 35678B	
Type N Test Port Extension Cables	HP 35679A ¹	HP 35679A ¹	HP 35679A ¹	HP 35679B	
Power Splitters	11850C or 11667A	HP 35679A	11850D		
MINIMUM LOSS PAD AND ACCESSORY KITS					
Type N Minimum Loss Pad			11852A ³		
Type N Accessory Kit	11853A	11853A	11855A	11855A	
BNC Accessory Kit	11854A	11854A	11856A	11856A	11854A
TRANSISTOR FIXTURES					
To-18/To-72 Transistor Fixture		11600B			
To-5/To-12 Transistor Fixture		11602B			
Transistor Fixture Adapter		11858A ⁴			
PROBES					
500 MHz Active Probe					41800 ²
1:1 Miniature Probe					10438A ²
10:1 Miniature Probe					10433A ²

¹ 2 pair recommended

² 3 ea recommended

³ 4 ea recommended

⁴ Requires 2ea 11525A APC-7 to Type N Male adapters for use with the HP 35677A

Accessories Available

Table 5-1 lists the accessories available for the HP 3577A. These accessories may be obtained through your HP Sales and Service office.

Accessories Supplied

Table 5-2 lists the accessories supplied with the HP 3577A Network Analyzer and the HP 35677A S-parameter test set.

Table 5-2.

For the HP 3577A		
Power cord	(Qty. 1)	see figure 5-1
Type N(m)-to-BNC(f) adapters	(Qty. 4)	1250-0780
For the HP 35677A/B		
Interconnect cable	(Qty. 1)	35677-61620
190 mm (7.5 in) 50Ω cable	(Qty. 4)	8120-4387
Cabinet lock foot kit	(Qty. 1)	5062-3999

Options

Table 5-3 lists the options available for the HP 3577A. These options are available either when the instrument is ordered or for later installation.

Table 5-3.

Option	Description	HP Part Number
For the HP 3577A		
907	Front Handle Kit	5062-3991
908	Rack Mounting Kit	5062-3979
909	Front Handle & Rack Mount Kit	5062-3985
910	Additional Service Manual - OR -	03577-90012
	Additional Operating Manual	03577-90002
For the HP 35677A/B		
907	Front Handle Kit	5062-3988
908	Rack Mounting Kit	5062-3974
909	Front Handle & Rack Mount Kit	5062-3975
910	Additional Service Manual - OR -	35677-90010
	Additional Operating Manual	03577-90002

Installation

The HP 3577A is shipped with plastic feet attached to the bottom panel, ready for use as a bench instrument. The feet are shaped to make full-width modular instruments self align when they are stacked. Because of its weight, the HP 3577A is not equipped with a tilt stand. It is recommended that a Front Handle Kit (Option 907, HP Part No. 5062-3992) be installed for ease of handling the instrument on the bench.

The HP 35677A/B S-parameter test set was designed to be mounted to the bottom of the HP 3577A Network Analyzer as follows:

1. Install the Rear Panel Lock foot kit (5062-3999) as indicated by the kit instructions. This fastens the two instruments together using four slide-together clips across the front edges and two lock feet mounted at the corners of the rear panels' common side.
2. Install the test set interconnect cable (35677-61620) between the rear panels of both instruments as shown in figure 5-2. This cable
 - a. Supplies power and ground
 - b. Lets the analyzer sense the presence of the test set (changes the INPUT menu)
 - c. Controls the test set's coaxial switch.

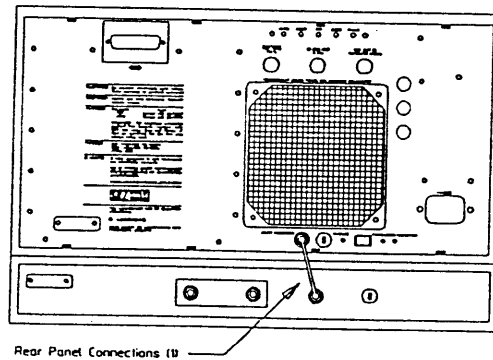

Figure 5-2. Rear panel Interconnect cable Installation

3. Install the four N-connector 50 Ω cables (HP part number 8120-4387) between the front panels of the two instruments as shown in figure 5-3.

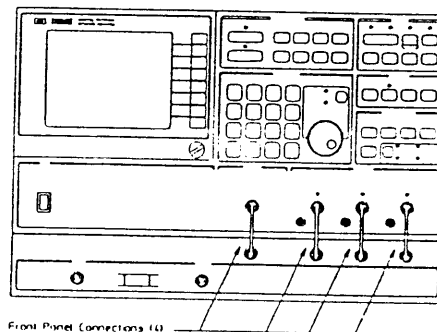

Figure 5-3. Front panel cable Installation

The HP 3577A may be rack mounted with or without slides. Both mountings may be utilized for maximum strength and safety.

To rack mount without slides:

1. Remove the plastic trim and front handles if so equipped.
2. Remove the plastic feet from the bottom of the HP 3577A.
3. Install the flange kit with or without handles according to instructions included with the kit:
Rack Flange Kit(no handles)...Option 908, HP P.N. 5062-3979
Rack Flange & Front Handle Kit...Option 909, HP P.N. 5062-3985
4. Install an Instrument Support Rail on each side of the instrument rack. (The Instrument Support Rails, used to support the weight of the instrument, are included with HP rack-mount cabinets.)

Warning



1. The weight of the HP 3577A must be supported by Instrument Support Rails inside the instrument rack. DO NOT, UNDER ANY CIRCUMSTANCES, ATTEMPT TO RACK MOUNT THE HP 3577A USING ONLY THE FRONT FLANGES.

2. The HP 3577A is heavy (approximately 62 Lbs, 28 kg.). Use extreme care when lifting it to avoid personal injury.

5. Using *two* people, lift the HP 3577A to its position in the rack on *top* of the Instrument Support Rails.
6. Using the appropriate screws, fasten the HP 3577A's Rack-Mount Flanges to the front of the instrument rack.

To rack mount with slides, the following items are required:

Quantity	Description
1	Rack Flange Kit (Option 908, HP 5062-3979) OR Rack Flange & Handle Kit (Option 909, HP 5062-3985)
1	Heavy-Duty Slide Kit (HP Part Number 1494-0016)

Note



Instrument Support Rails are not absolutely necessary when rack mounting with slides. However, they do relieve a considerable amount of strain from the slides and provide an extra measure of safety.

1. Perform Steps 1 through 4 of the previous procedure.
2. Attach a slide inner-member bracket to each side of the HP 3577A.
3. Attach the slide's outer members to the instrument rack according to the instructions included with the slides.
4. If your instrument rack has extension legs on the front, be *sure* that they are extended at this time.
5. Using *two* people, lift the HP 3577A to its position in the rack and mate the two sections of the slides together. Do *not* rest the full weight of the HP 3577A on the extended slides until you are sure the instrument rack will not overturn.
6. Slide the HP 3577A into the rack. Using the appropriate screws, fasten the HP 3577A's Rack Mount Flanges to the front of the rack.

If alignment of the display is necessary, perform the following:

1. Power ON.
2. Press the SPCL FCTN hardkey.
3. Press the TEST PATTERN softkey.
4. Adjust HORIZ and VERT on the rear panel to center the pattern on the face of the CRT.
5. Adjust ALIGN on the rear panel (which rotates the display) until the bottom of the display is parallel to the bottom of the bezel.
6. Adjust FOCUS and ASTIG on the rear panel until the lines on the display are sharp and clear. It may be easier to align this using a dot on the screen; press INSTR PRESET and use one of the decimal points in the alphanumeric.

HP-IB Connections

The HP 3577A Network Analyzer is designed for use with the Hewlett-Packard Interface Bus (HP-IB).

Note



The HP-IB is Hewlett-Packard's implementation of IEEE standard 448-1978, "Standard Digital Interface for Programmable Instrumentation."

The HP 3577A is connected to the HP-IB by connecting an HP-IB interface cable to the HP-IB connector on the rear panel. Figure 5-4 illustrates a typical HP-IB system in interconnection.

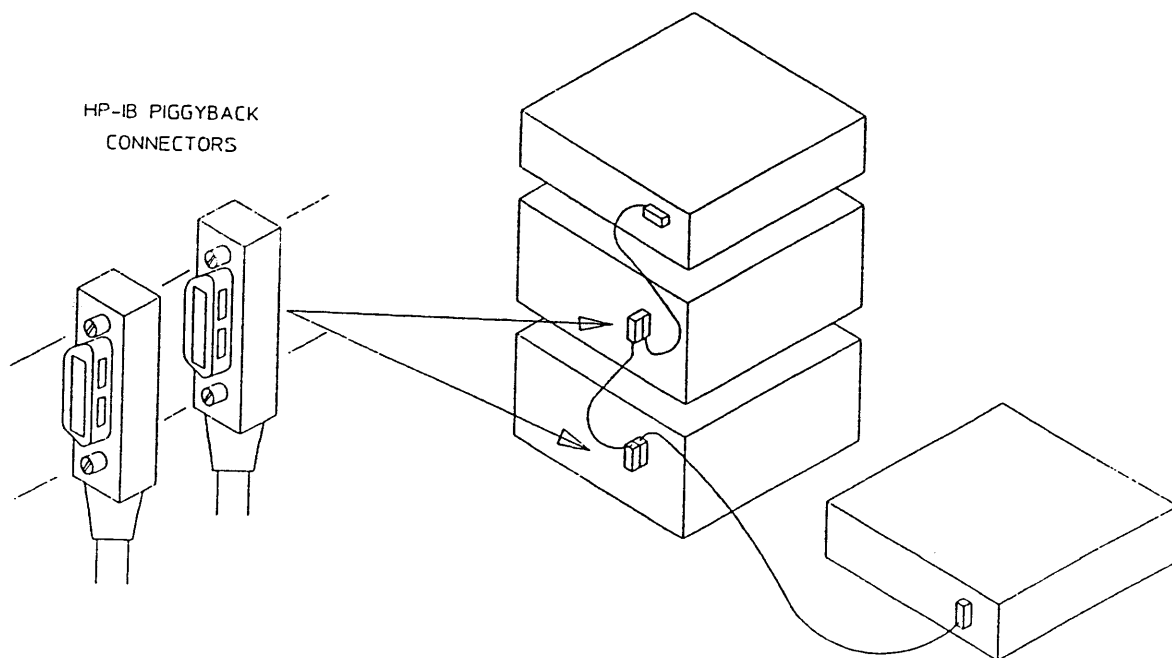

Figure 5-4. A typical HP-IB system Interconnection

General Information
HP-IB Connections

With the HP-IB system, up to 15 HP-IB compatible instruments can be interconnected. The HP 10833 HP-IB cables have identical piggy-back connectors on each end so that several cables can be connected to a single source without special adapters or switch boxes. System components and devices can be connected in virtually any configuration as long as a path exists between each device and the controller. As a practical matter, avoid stacking more than three or four cables on any one connector. If the stack gets too long, force on the stack can produce sufficient leverage to damage the connector mounting. Be sure that each connector is firmly screwed in place to keep it from working loose during use. The HP 3577A uses all the available HP-IB lines; therefore, damage to any connector pin may adversely affect HP-IB operation. See figure 5-5.

To achieve design performance with the HP-IB, proper voltage levels and timing relationships must be maintained. If the system cable is too long, the lines cannot be driven properly and the system will fail to perform.

Total cable length for the system must be less than or equal to 20 meters (65 feet) or 2 meters (6 feet) times the total number of devices connected to the bus, whichever is less.

Caution



The HP 3577A contains metric threaded HP-IB cable mounting studs as opposed to English threads. Metric threaded HP 10833A, B, C, or D HP-IB cable lockscrews must be used to secure the cable to the instrument. Identification of the two types of mounting studs and lockscrews is made by their color. English threaded fasteners are colored silver and metric threaded fasteners are colored black. **DO NOT** mate silver and black fasteners to each other or the threads of either or both will be destroyed.

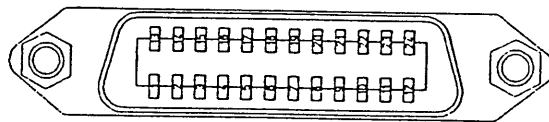

PIN	LINE
1	D101
2	D102
3	D103
4	D104
13	D105
14	D106
15	D107
16	D108
5	E01
17	REN
6	DAV
7	NRFD
8	NDAC
9	#FC
10	SRO
11	AIN
12	SHIELD-CHASSIS GROUND
18	P/O TWISTED PAIR WITH PIN 6
19	P/O TWISTED PAIR WITH PIN 7
20	P/O TWISTED PAIR WITH PIN 8
21	P/O TWISTED PAIR WITH PIN 9
22	P/O TWISTED PAIR WITH PIN 10
23	P/O TWISTED PAIR WITH PIN 11
24	ISOLATED DIGITAL GROUND

HP-IB Interconnect Cables	
PART NUMBER	LENGTH
10833A	1 m (3.3 ft)
10833B	2 m (6.6 ft)
10833C	4 m (13.2 ft)
10833D	0.5 m (1.6 ft)

THESE PINS ARE INTERNALLY GROUNDED

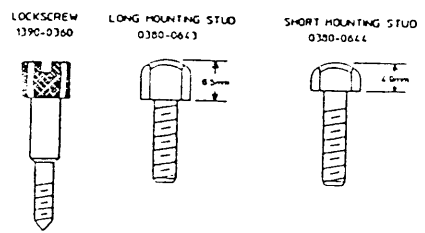

Figure 5-5. HP-IB Interfacing

Storage and Shipment

Environment The HP 3577A and HP 35677A/B should be stored in a clean, dry environment. The following are environmental limitations that apply to both storage and shipment.

Temperature	- 40° C to +75° C
Humidity	Up to 95% relative
Altitude	Up to 15,300 meters (50,000 feet)

The instruments should also be protected from temperature extremes which cause condensation.

Original Packaging Containers and materials equivalent to those used in factory packaging are available through Hewlett-Packard Offices. If the instrument is being returned to Hewlett-Packard for service, attach a tag indicating the type of service required, return address, model number, and full serial number. Also, mark the container **FRAGILE** to ensure careful handling. In any correspondence, refer to the instrument by model number and full serial number.

Other Packaging The following general instructions should be followed for repackaging with commercially available materials:

1. Wrap the instrument in heavy paper or anti-static plastic. If the instrument is being shipped to a Hewlett-Packard office or service center, attach a tag to the instrument indicating type of service required, return address, model number, and full serial number.
2. Use a strong shipping container. A double-wall carton made of 350 pound test material is adequate.
3. Use a layer of shock absorbing material 70 to 100 mm (3 to 4 inches) thick around all sides of the instrument to provide firm cushioning and prevent movement inside the container. Protect the front panel with cardboard.
4. Seal shipping container securely.
5. Mark shipping container **FRAGILE** to ensure careful handling.
6. In any correspondence, refer to the instrument by model number and full serial number

Caution



Styrene pellets in any shape should not be used as packing material. The pellets do not adequately cushion the instrument and do not prevent the instrument from shifting in the carton. The pellets also create static electricity which can damage electronic components.

HP 3577A Network Analyzer Specifications

Source Characteristics

■ Frequency Characteristics

Frequency Range: 5 Hz to 200 MHz.

Frequency Resolution: 0.001 Hz.

Stability: for Option 001, $\pm 5 \times 10^{-8}$ /day, 0 to 55° C (applicable for instrument on continuously ≥ 48 hours.)

■ Output Characteristics

Level Range: +15 dBm to -49 dBm (1.26 Vrms to 793 μ Vrms; 2 dBV to -62 dBV) into a 50 Ω load.

Resolution: 0.1 dB.

Entry Units: dBm, dBV, V.

Accuracy: ± 1 dB at +15 dBm and 100 kHz. Below +15 dBm, add the greater of ± 0.02 dB/dB or 0.2 dB.

Flatness: 1.5 dBpp from 5 Hz to 200 MHz.

Impedance: 50 Ω ; > 20 dB return loss at all levels.

RF Output Connector: 50 Ω Type N female.

Spectral Purity:

Phase Noise (in 1 Hz Bandwidth):

< -70 dBc at offset frequencies from carrier of 100 Hz to 20 kHz.

Harmonics: < -25 dBc.

Non-Harmonic Spurious Signals:

< -50 dBc or -70 dBm whichever is greater.

Reverse Power Protection: Output is automatically opened at a signal level of approximately +22 dBm (50 Ω), or ± 4 Vdc, or greater applied to the source output. Source output is reconnected with the Clear Trip function.

■ Sweep Characteristics

Linear Frequency:

Range: 5 Hz to 200 MHz.

Entry: Start/stop or center/span frequencies.

Span: 0 Hz or 0.01 Hz to 200 MHz, phase continuous.

Sweep Time: 100 ms/span to 6553 s/span.

Direction: Increasing or decreasing frequency.

Log Frequency (segmented linear approximation):

Range: 5 Hz to 200 MHz.

Entry: Start/stop frequencies.

Span: 0.01 Hz to 200 MHz, phase continuous.

Log Accuracy: 2%.

Sweep Time: 200 ms/span to 6553 s/span.

Sweep Direction: Increasing frequency.

Alternate Frequency: Sweep alternates between two separate start/stop frequencies using linear sweep only.

Discrete: From 2 to 51 discrete frequencies at points of interest. Resolution bandwidth and setting time are individually settable. The minimum measurement time for each frequency is typically 10 ms. The discrete sweep table becomes part of the instrument state.

Sweep Direction: Increasing or decreasing frequency.

CW: Frequency is fixed. Data is updated with a selectable sample time from 1 ms to 16 s.

Log Amplitude (fixed frequency):

Range: +15 dBm to -49 dBm.

Entry: Start/stop level in dBm or dBV.

Sweep Time: 1 ms/step to 16 s/step. Total sweep time/span depends upon total number of steps and time/step.

Sweep Modes: Continuous, single, manual.

Trigger Modes: Free run, immediate, line, external.

Appendices

Special Topics Appendix A

Data Processing and Structure

Knowing how the HP 3577A takes measurements and what it does with the data will increase your effectiveness as a user. This section presents and explains the operating system flow chart of the HP 3577A Network Analyzer. For the following discussion refer to the flow chart in figure A-1.

The synthesized source sweeps the selected span continuously (when not in CW sweep type or manual sweep mode) while the 3 receivers take measurements, digitize them, and output the data. The processor accepts data from the receivers only at certain frequencies. These are usually 401 equally spaced "bins" in the sweep span, but 201, 101, or 51 points/sweep may be selected for the sweep resolution. Each bin is as wide as the selected resolution bandwidth and has associated with it a frequency number (position information) and measurement value. Bins do not always overlap.

The process shown in the flow chart operates on one bin at a time. Data is taken and a point plotted on the screen before the next bin is sampled.

The receiver's output values are complex numbers of the form $(X + jY)$, where X is real and jY imaginary. Two numbers (X & Y) are transferred to the processor for each bin. Data is collected from all three receivers simultaneously.

If the average or length features are in use, the processor implements those functions at this point and then stores the results in trace memory. Trace memory is used to store the complex numbers representing inputs R , A , B , and storage registers $D1$, $D2$, $D3$, and $D4$.

If length and average are inactive, the measurement data is stored in trace memory without change. This point is emphasized because the average and length functions change what is stored in trace memory. Consider the case of single sweep mode. After the data is taken it may be formatted to any of a number of configurations, but changing length or average has no effect. Trace inputs, display functions, or scale may be changed and the display updated from trace memory without taking another measurement. If length or average are changed, a new measurement (sweep) must be taken and data stored in trace memory before the screen can be updated. Any math processing that occurs after data has been stored in trace memory registers R , A , and B , operates on this complex data.

Next, the operating system executes a store if it has been requested. If a **STORE** is executed, source sweep and receiver measurements are interrupted while a memory sweep of trace memory occurs. If a simple "STORE REG D_" is executed (i.e. not USER DEF STORE) then the **STORE** math is the same as the **INPUT** math; the trace is stored using the current **INPUT** definition. If a **USER DEF STORE** command is given, the user defines the math done (and the data stored is not displayed). Changes in display function do not change what is stored. The data in trace memory may be processed by any display function and displayed as magnitude, phase, delay, etc. information. After the **STORE** math is complete the data is stored in the register specified by the user (D1-D4).

Next, (unless this was the last bin) the operating system continues the memory sweep, repeating this process for each bin. The displayed trace is not affected unless the input definition is a function of the storage register used.

If a **STORE** is not requested, the next step is to do the math defined by the **INPUT** function. Then, if **PHASE SLOPE** is on and the value is non-zero, the **PHASE SLOPE** math is done. Complex numbers are the result of all processing done up to this point. This data is then processed according to the definition of **DISPLAY FUNCTION**, resulting in a high-precision, floating point, scalar number. This number is stored in main memory for readout as **MARKER** data. The same number is then processed according to the **SCALE** definitions for placement on the display. These two scalar numbers provide

1. A trace that stays within the boundaries of the figure A-1 graticule and
2. Good measurement data readout (via the marker) for all portions of the frequency span, even where the trace is off screen.

If a function change does not require new measurements to update the trace, a memory sweep occurs. The processor sweeps through the complex data in trace memory and updates the trace very quickly. The speed in which this happens is limited only by the rate at which the processor can manipulate numbers. If the processor is given a lot of math to do (averaging, length, and complicated user definitions for two traces) the HP 3577A may choose a slower sweep speed to allow time for the number processing. The message "SWEEP TIME INCREASED" appears on the screen when this happens.

It is important to keep in mind how the HP 3577A does math and the form of the complex data in trace memory when defining user defined equations for inputs, stores, or functions. For example, to find the difference in phase between inputs R and A the **INPUT** definition should be A/R, not A-R. See figure A-2.

if: $A = X + jY = Me^{j\theta_1}$
 $R = S + jT = Ne^{j\theta_2}$

then: $INPUT = A/R = (M/N)e^{j(\theta_1 - \theta_2)}$ where $(\theta_1 - \theta_2)$ is the phase displayed

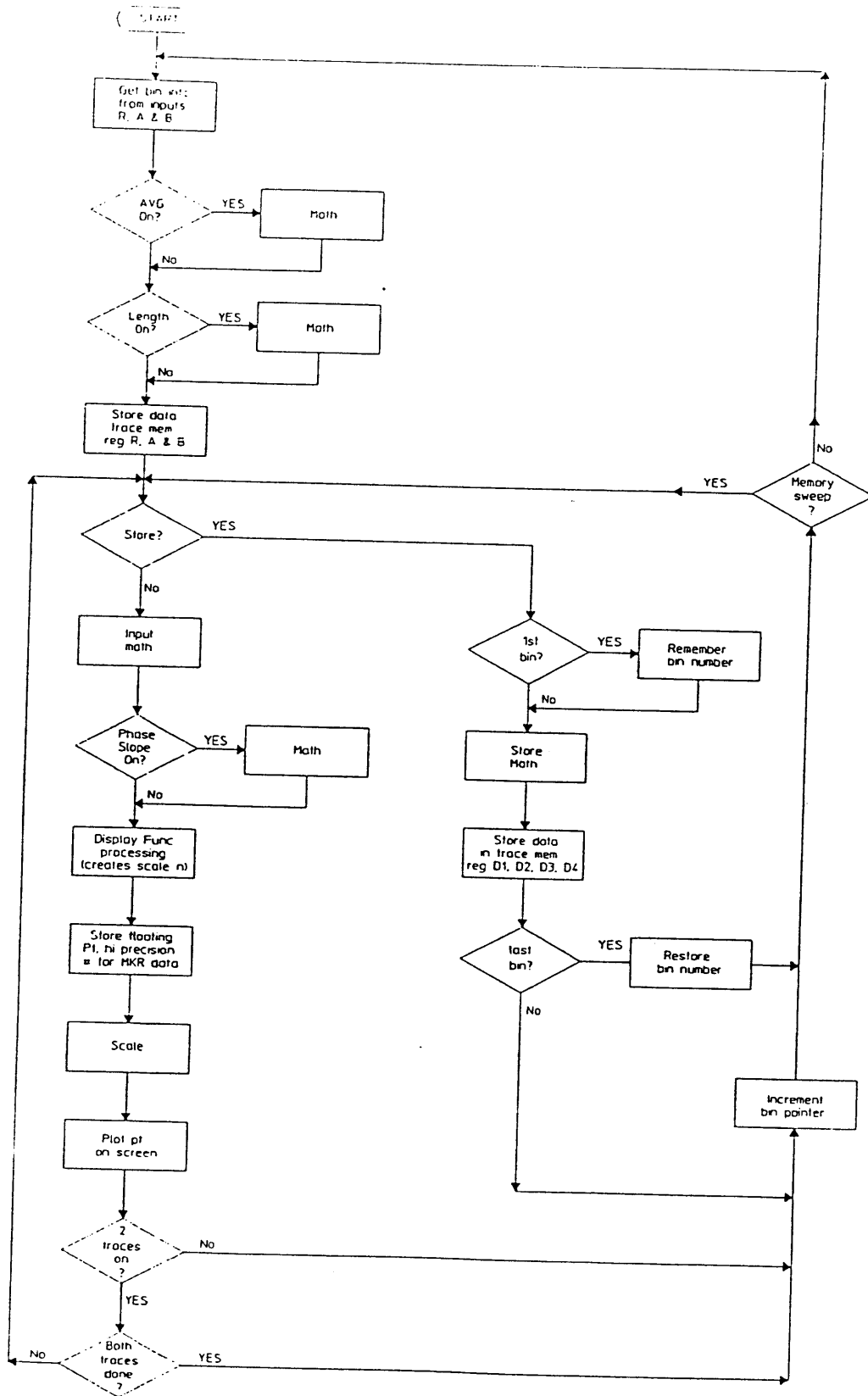

Figure A-1

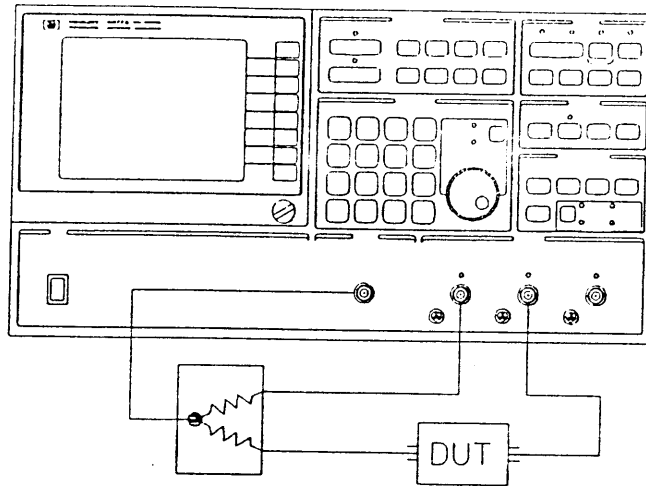

Figure A-2

Optimizing Sweep Time

The HP 3577A Network Analyzer has 4 selections for bandwidth: 1kHz, 100Hz, 10Hz, and 1 Hz. While each reduction in bandwidth lowers the noise floor, it also results in an increase in the pre-sweep settling time (done automatically) and may require selection of a longer **SWEEP TIME**. This discussion is to help the user find the optimum Sweep Time for a given Resolution Bandwidth.

Settling time is the time that the source holds at the start frequency before beginning the sweep. This is done to allow the source amplitude and filters time to stabilize before starting the measurement. While the HP 3577A is settling the SETTLE LED is illuminated. The settling time is 22 ms for a 1 kHz bandwidth and progressively longer for narrower bandwidths (see Resolution Bandwidth in the Reference section). Settling time changes automatically unless the user chooses to turn it off using the **SPCL FCTN** key.

There is no rigorous method for selecting **SWEEP TIME**, given **RES BW**; too much depends on the response time of the device under test. The filters of the HP 3577A have a finite response time as does the circuit being tested. If the **SWEEP TIME** is too short there is not enough time to allow both to respond fully to each sampled frequency. When the sweep direction is up (i.e., increasing frequency, the default condition) this phenomena is evident as a skewing of the trace to the right.

The object is to make an accurate measurement with as short a **SWEEP TIME** as possible. There are several ways to decide whether or not the sweep time is too small:

1. Increment (increase) the **SWEEP TIME** and look for a change in the trace shape. If there is, then the previous **SWEEP TIME** was too small. Continue incrementing until no change is seen.
2. Reverse the sweep direction when the sweep dot is on the steepest part of the response. If the **SWEEP TIME** is too small the trace skews to the left (or right, depending on sweep direction) and the dot does not retrace its path. Increment the **SWEEP TIME** and try again.
3. Let the HP 3577A sweep once and then select **MANUAL FREQUENCY SWEEP MODE**. Move the marker to the steepest part of the response and press the **MKR → MANUAL** softkey. If the marker is not on the trace the sweep time is too small.

Remote Graphics Appendix B

To enter display graphics under remote control, display commands must be issued to the Digital Display Module using the ENA HP 3577A HP-IB code as described in this quick reference.

Digital Display Quick Reference Guide

Digital Display Commands

Note

Bit D15 is used only for vector memory board commands. For standard Digital Display commands D15 should be 0.

Digital Display 16 Bit Data Word.

MSB																	LSB
D14	D13	D12	D11	D10	D9	D8	D7	D6	D5	D4	D3	D2	D1	D0			
COMMAND		COMMAND MODIFIERS															

	Bit 14	Bit 13
Set Condition	1	1
Plot Command	0	0
Graph Command	0	1
Text Command	1	0

Set Condition Command

Set Condition Command:

MSB																	LSB
D14	D13	D12	D11	D10	D9	D8	D7	D6	D5	D4	D3	D2	D1	D0			
1	1	I ₁	I ₀	X	X	L ₁	L ₀	0	X	W ₁	W ₀	X	X	X			

Note: Bit 6 (D6) must be zero.

Command Modifiers:

a. To Set Line Intensity:

	I ₁	I ₀	Intensity
0	0	0	Blank
0	1	0	Dim
1	0	0	Half Brightness
1	1	0	Full Brightness

b. To Set Line Type:

	L ₁	L ₀	Type
0	0	0	Solid Line
0	1	0	Intensified End Points on Solid Line
1	0	0	Long Dashes
1	1	0	Short Dashes

c. To Set Writing Speed:

	W ₁	W ₀	Speed
1	1	0	0.05in. per μ s
1	0	0	0.10 in. per μ s
0	1	0	0.15 in. per μ s
0	0	0	0.20 in. per μ s

Plot Command

Plot Command:

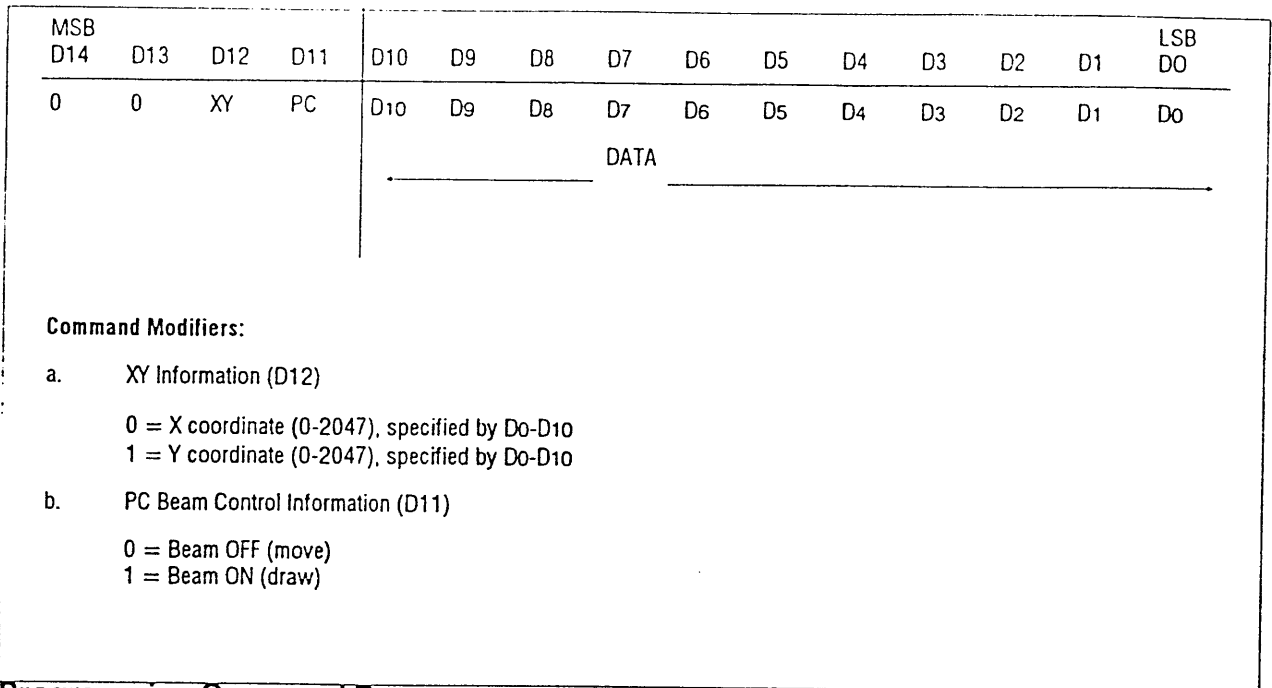

Programming Command Ranges

Programming Command Ranges		
Digital Display Command	Octal Range	Hexidecimal Range
a. Plot		
X	00000-07777	0000-OFFF
Y (beam off)	10000-13777	1000-17FF
Y (beam on)	14000-17777	1800-1FFF
b. Graph		
Set Delta-X	20000-27777	2000-27FF
Y (beam off)	30000-33777	3000-37FF
Y (beam on)	34000-37777	3800-3FFF
c. Text	40000-57777	4000-5FFF
d. Set Condition	60000-77777	6000-7FFF

Graph Command

Graph Command:

MSB															LSB	
D14	D13	D12	D11	D10	D9	D8	D7	D6	D5	D4	D3	D2	D1	D0		
0	1	XY	PC	D10	D9	D8	D7	D6	D5	D4	D3	D2	D1	D0		
DATA																

Command Modifiers:

- a. XY Information (D12)
 - 0 = Set Delta-X increment, specified by D0-D10 for all subsequent Y coordinates
 - 1 = Set Y coordinate, specified by D0-D10. The beam is to be moved to this Y in conjunction with the Delta X increment.
- b. PC Beam Control Information (D11)
 - 0 = Beam OFF (move)
 - 1 = Beam ON (draw)

Memory Board Commands

Vector Memory Word

M15	M14	M13	M12	M11	M10	M9	M8	M7	M6	M5	M4	M3	M2	M1	M0
0	B14	B13	B12	B11	B10	B9	B8	B7	B6	B5	B4	B3	B2	B1	B0

(SEE DATA BIT DEFINITIONS FOR DIGITAL DISPLAY COMMANDS)

Internal Jump

An internal jump does not affect the Vector Memory address pointer.

M15	M14	M13	M12	M11	M10	M9	M8	M7	M6	M5	M4	M3	M2	M1	M0
1	0	X	X	A11	A10	A9	A8	A7	A6	A5	A4	A3	A2	A1	A0

X = DON'T CARE

M15 = 1, M14 = 0; Internal jump to Vector Memory address specified by A11 thru A0 during refresh.

Address Pointer

M15	M14	M13	M12	M11	M10	M9	M8	M7	M6	M5	M4	M3	M2	M1	M0
X	X	X	X	A11	A10	A9	A8	A7	A6	A5	A4	A3	A2	A1	A0

X = DON'T CARE

A0 = 0; Set pointer register to the Vector Memory address value specified by A11 thru A0.

Digital Display Modified ASCII Character Set

DIGITAL DISPLAY MODIFIED ASCII CODE CONVERSION TABLE								
	MOST SIGNIFICANT CHARACTER							
	0	1	2	3	4	5	6	7
0		center	SP	0	@	P	'	p
1	HP logo	centered o	!	1	A	Q	a	q
2	β	↑	"	2	B	R	b	r
3		←	#	3	C	S	c	s
4	upper-half tic	↓	\$	4	D	T	d	t
5	lower-half tic	→	%	5	E	U	e	u
6	left-half tic	√	&	6	F	V	f	v
7	right-half tic	π	'	7	G	W	g	w
8	back space	Δ	(8	H	X	h	x
9	1/2 shift down	μ)	9	I	Y	i	y
A	line feed	°(degree)	*	:	J	Z	j	z
B	inv. line feed	Ω	+	;	K	[k	{
C	1/2 shift up	ρ	,	<	L	\	l	
D	carriage return	Γ	-	=	M]	m	}
E	horizontal tic	θ	.	>	N	^	n	□
F	vertical tic	λ	/	?	O	—	o	▷

<u>EXAMPLES:</u>		
HP logo	=	01
A	=	41
i	=	69
√	=	16
▷	=	7F
line feed	=	09

Capabilities for Character and Vector Combinations

Conditions				
Average character drawing time: 16 sec				
Recommended refresh rate: 60 Hz ~ 16.6 msec				
Digital Display writing speed: 0.1 in/sec				
Vector dead time: 1 sec				
	NUMBER OF CHARACTERS TO BE DRAWN			
	0	100	200	300
Total frame time (msec)	16.67	16.67	16.67	16.67
Character writing time (msec)	0	1.6	3.2	4.80
Time left to draw vectors(msec)	16.67	15.07	13.47	11.87
AVERAGE VECTOR LENGTH	APPROXIMATE NUMBER OF VECTORS DRAWN			
0.1 in	8330	7530	6730	5930
0.5 in	2770	2510	2240	1970
2.0 in.	790	710	640	560
6.0 in.	270	240	220	190

Text Command

Text Command:

MSB														LSB
D14	D13	D12	D11	D10	D9	D8	D7	D6	D5	D4	D3	D2	D1	D0
1	0	S1	S0	R1	R0	ES	C7	C6	C5	C4	C3	C2	C1	C0
CHARACTER														

Command Modifiers:

For C0-C7, see ASCII Conversion Table

a. ES Establish Size of Character

0 = Use previous size and rotation

1 = Establish new size and rotation according to S1, S0, R1 and R0

b. Rotate Character counter-clockwise

R1	R0	Rotation
0	0	0 degrees
0	1	90 degrees
1	0	180 degrees
1	1	270 degrees

c. Character Size

S1	S0	Size	W × H (in addressable points)
0	0	1×	24 × 36
0	1	1.5×	36 × 54
1	0	2×	48 × 72
1	1	2.5×	60 × 90

4 PROGRAMMABLE CHARACTER SIZES:
1.0 × 56 characters per line, 29 horizontal lines possible.
1.5 × 37 characters per line, 19 horizontal lines possible.
2.0 × 28 characters per line, 14 horizontal lines possible.
2.5 × 22 characters per line, 11 horizontal lines possible.

Character Rotation

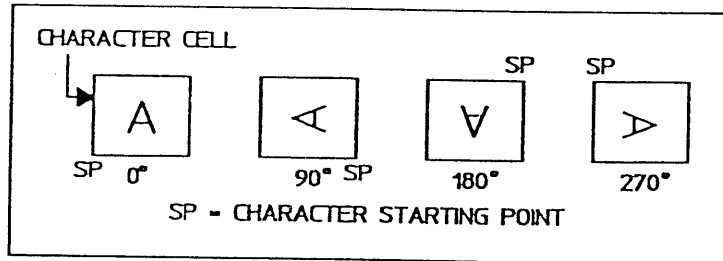

Screen Messages Appendix C

The HP 3577A Network Analyzer displays operator messages to inform the user of various conditions. These fall into three categories: instructions or informative messages, warning messages, and error messages. Under remote control, the user may select the message category level that pulls SRQ and appears in the DUMP STATUS command as defined by the error reporting mode selected. Refer to "Masking the Status Byte" in the section on Remote Operation. In the following table W is used for warning, E is for error, and M for general information messages.

MESSAGE	W - Warning E - Error	DESCRIPTION
1 MHz FAILURE	E	Hardware failure.
DIGITAL DISPLAY JUMP CMND DISALLOWED	E	HP-IB. Use of the digital display module command is illegal when entering graphics.
1 MHz & 8 kHz FAILURE	E	Hardware failure.
8 kHz FAILURE	E	Hardware failure.
ABORT CAL SOFTKEY ONLY	W	During MEASR CAL Sweeps and CAL processing, the only key to which the HP 3577A responds (besides INSTR PRESET) is ABORT CAL.
AMPLITUDE SWEEP TIMEOUT	E	Amplitude sweep operate in the CONTINUOUS SWEEP MODE for five minutes before changing to SINGLE, to prevent excessive wear on the output relays. See AMPLITUDE SWEEP TYPE.
AVG TURNED OFF IN ALT SWP	W	If AVERAGE is on and ALTERNATE SWEEP TYPE is selected, this message appears. It is not possible to use averaging with ALTERNATE SWEEP.
CONFIDENCE TEST FAILED	E	One or more of the confidence tests do not pass. Hardware failure.
CONFIDENCE TEST PASSED	M	All confidence tests passed.
CONT CAL NOT ALLOWED	E	HP-IB. Continue CAL not allowed unless in the MEASR CAL sequence.
COPY NEEDS "FROM" TRC ON	E	Both traces should be on to COPY SCALE. This message appeared because one is inactive.
DATA ERROR #_	E	HP-IB. User-entered data may cause data errors when, involved in trace arithmetic. This message may also indicate a hardware failure.
DATA INPUT ABORTED	E	HP-IB. Data transfer to the HP 3577A has stopped.
DATA OUTPUT ABORTED	E	HP-IB. Data transfer from the HP 3577A has stopped.

Appendix C
Screen Messages

MESSAGE	W - Warning E - Error	DESCRIPTION
DELAY APERTURE INCREASED	W	Delay aperture is increased automatically when necessary as the sweep resolution is decreased. This message appears when the display function is delay, aperture is small, and the user selects a reduced sweep resolution.
DISPLAY MEMORY TEST FAILED	E	Hardware failure.
DISPLAY MEMORY TEST PASSED	E	For more details refer to the Service Manual.
ENTRY SET TO 0.0	W	An extremely small number has been rounded to zero.
ENTRY TOO LONG	E	Data entered has too many characters. Limit is 17.
ENTRY UNDEFINED	E	Keys in the numeric key pad have been pressed when no data entry softkey is active in the menu.
EOI BEFORE INPUT COMPLETE	E	HP-IB. End Or Identify asserted (indicating end of data) when more data was expected.
EXPECTED "#!"	E	HP-IB. In the binary format, data to be loaded should be preceded by the characters #!
FP CANNOT ACCESS TRACE MEM	E	Hardware failure.
FP CNTR/RCVR FAILURE	E	Hardware failure of either the Fast Processor counter or a receiver input channel.
FP LOGIC FAILURE	E	Fast Processor hardware failure.
FAST PROC NOT GRANTING BUS	E	Hardware failure.
FP SELF TEST PASSED	E	For more details, see the Service Manual.
FP-MP COMMUNICATION ERROR	E	Hardware failure.
FRONT PANEL DECODING ERROR	E	Hardware failure.
FRONT PANEL KEY STUCK	E	One of the front panel keys has been depressed for ten seconds or more or is stuck.
ILLEGAL "#" RECEIVED	E	HP-IB. # is a special character and may only be used for its intended function.
ILLEGAL SYMBOL	E	User defined math equation entry that is not a legal symbol.
INCOMPATIBLE DISPLAY FCTNS	E	Attempt to COPY SCALE between traces when display functions' units are incompatible.
INCOMP. TESTSET POSITIONS Trc_ chgd to agree with #_	W	Incompatible S-parameter test set positions, trace changed to agree with trace number (2 or 1)" (i.e. the HP 35677A/B can't be configured forward and reverse at the same time so the INPUT of the other trace has been changed).
INP MUST BE A,B,R,A/R,B/R	E	For NORMALIZATION, the INPUT must be defined as one of these RECEIVER input expressions.

MESSAGE	W - Warning E - Error	DESCRIPTION
INP SHOULD BE USER-DEFINED	E	HP-IB. Set INPUT to be USER DEF before attempting to directly change the configuration of the S-parameter test set over the bus.
INPUT(S) __ TRIPPED	E	One or more of the RECEIVER channels has switched to 1 MΩ impedance. (The message indicates which receiver inputs have tripped). This message is accompanied by a message to "Clear trip on ATTEN menu."
INVALID EXPRESSION	E	User defined equation not valid such as A/R. More common for HP-IB than front panel entries.
INVALID HPIB COMMAND	E	HP-IB. Code sent to HP 3577A not a valid HP 3577A HP-IB Code.
INVALID LEARN MODE DATA	E	HP-IB. The checksum of the instrument state just loaded is incorrect, possibly because the attempted to modify instrument state data outside the HP 3577A.
INVALID START ADDRESS	E	HP-IB. Start address for ENG must be an integer between 0 and 923.
INVALID SUFFIX	E	HP-IB. Code sent to HP 3577A for a data entry suffix is not appropriate for prefix parameter or instrument state.
KEY BUFFER FULL	W	The front panel key buffer can hold 6 key presses for processing.
KEY NOT APPLICABLE	E	When in MANUAL sweep mode and ALTERNATE sweep type with trace one active (and trace two is not off) this error message appears if MKR → MAN FREQ is used. This is permitted only for trace two in this situation.
KEY NOT IN MENU	E	HP-IB. Command issued over the bus is not allowed; if the label does not appear in the menu during local operation, it cannot be used over the bus (e.g., "Smith chart" in a rectangular display function).
MARKER OFFSET IS OFF	E	Cannot use MKR OFST → SPAN if the OFFSET MARKER is OFF.
MARKER __ IS OFF	E	Request to plot one of the markers or execute a MKR → operation but the marker is not on.
MEM FAIL-SAVED STATES LOST	E	A memory hardware failure has occurred and the instruments states which had been saved have been lost.
MP/FP PORT TEST FAILED	E	The test run on the port between the Main Processor and the Fast Processor has failed. Hardware failure.
MP/FP PORT TEST PASSED	E	For more details see the Service Manual.
NO CHARACTERS TO PLOT	E	HP-IB. Request to plot characters that have been turned off.
NO COMMA IN TRACE ARITH	E	HP-IB. Comma not allowed in trace arithmetic.
NO GRATICULE TO PLOT	E	HP-IB. Request to plot a graticule that has been turned off.

Appendix C
Screen Messages

MESSAGE	W - Warning E - Error	DESCRIPTION
NO INPUTS ARE TRIPPED	W	Results from pressing CLEAR TRIP in the ATTN menu when no inputs were tripped.
NO KEYBOARD ATTACHED	E	Hardware failure.
NO LISTENER ON BUS	E	User has requested data dump (such as PLOT ALL) and there is no listener on the bus.
NO RESPONSE FROM FP	E	Fast Processor didn't respond to self test. Hardware failure.
NO STORE & DISP IN POLAR	E	Illegal in polar display function.
NON-NUMERIC DATA RECEIVED	E	HP-IB. Data loaded was supposed to be ASCII number characters.
NOT ALLOWED IN ALT SWP	E	Functions not allowed when SWEEP TYPE is ALTERNATE are STORE, STORE & DISPLAY, and all CALIBRATION.
NOT ALLOWED IN LOG SWP	E	HP-IB. Display function DELAY is not allowed in LOG SWEEP.
NOTHING TO PLOT	E	HP-IB. Request to plot after all screen features have been turned off.
NUMBER OUT OF RANGE	E	Data entry of a value beyond the capabilities of the HP 3577A such as SOURCE AMPLITUDE of 100 dBm.
ONLY SMALLER FCNTS ALLOWED	E	When entering user defined functions, other functions may be used as terms in the new function as long as their function number is smaller.
OSCILLATOR UNLOCKED	E	Hardware failure.
OVERLOAD ON INPUT(S)_	E	One or more inputs are being overdriven by a large signal input but have not tripped. This warns the user that readings taken may be distorted.
RECALL FAILED-STATE IS BAD	E	The Instrument State the user tried to recall is bad so the recall failed. To clear the bad state, SAVE another state in the register. If this does not clear the problem cycle power while holding down SAVE and RECALL. This runs a special memory-clearing test that resets instrument state memory locations. See "In Case of Trouble" under Operating Hints in the Getting Started section.
REFERENCE UNLOCKED	E	The internal VCXO is not locked to the external reference input, possibly due to a difference in frequency exceeding 20 ppm. This message appears briefly during warm-up when the oven reference switches on after reaching operating temperature (~ 10 minutes from power-on).
SELECTED TRACE IS OFF	E	Can't perform the requested Operation because the trace is OFF (as with scale parameter changes).
SET HP-IB TO TALKONLY MODE	W	Before plotting. TALKONLY ON/OFF (in the SPCL FCTN menu) must be turned on.

MESSAGE	W - Warning E - Error	DESCRIPTION
SOURCE NOT TRIPPED	W	Results from pressing SOURCE CLEAR TRIP when the SOURCE wasn't tripped.
SOURCE TRIPPED	E	The Source Output is open (no power out). This is accompanied by a message to "Clear trip on AMPTD menu."
STOP MUST BE $\geq 1.05 \cdot \text{START}$	M	In log sweep the stop frequency must be greater than or equal to 1.05 X the start frequency.
STORED DATA D1-D4 LOST	E	Stored trace data in registers D1-D4 has been lost.
SWEEP MODE MUST BE MANUAL	E	HP-IB. User sent MKR \rightarrow MANUAL over the bus without first setting SWEEP MODE to MANUAL.
SWEEP RATE UNCALIBRATED	M	Selection of span and sweep time have resulted in a very slow sweep rate. Due to limited resolution of the frequency synthesis circuitry
SWEEP RESOLUTN TOO COARSE	E	DELAY APERTURE is limited by the selection of SWEEP RESOLUTION (in the FREQ menu). Coarse sweep resolution prohibits the use of small delay apertures. This message appears when the user tries to select a smaller aperture.
SWEEP SPAN LIMITED	M	This message appears when a center frequency and frequency span are selected such that the equivalent start or stop frequencies would be less than 0 Hz or greater than 200 MHz.
SWEEP TIME INCREASED	W	The sweep time has been increased automatically to allow enough time to do the required math processing.
SWEEP TIMING ERROR	E	Hardware failure.
SYSTEM ERROR #__	E	Hardware failure.
TALK ONLY MODE SELECTED	E	HP-IB. The HP 3577A has been manually set to TALKONLY (probably to plot). When addressed the HP 3577A must listen even though the softkey setting is TALKONLY.
TARGET VALUE NOT FOUND	W	A marker search did not find a the target value.
TEST SET RELAY TIMEOUT	E	Same timeout as described for AMPLITUDE SWEEP. See S-PARAMETER TEST SET.
TEXT STRING TOO LONG	E	HP-IB. Text string for ENA or ENM is too long.
TIMER INTERRUPT FAILURE	E	Hardware failure.
TOO MANY GRAPHICS COMMANDS	E	HP-IB. Enter Graphics code too long. Memory is limited to 924 16-bit commands.
TRACE_ HAS BEEN TURNED OFF or TRC 1, 2, ARE NOW TURNED OFF	W	One or both traces were group delay and the user selected a sweep type that does not allow group delay. This message is accompanied by a message that "DELAY IN LIN, ALT SWEEP ONLY." (Not LOG, CW or AMPTD)

Appendix C
Screen Messages

MESSAGE	W - Warning E - Error	DESCRIPTION
TRACE MEMORY TEST FAILED	E	Hardware failure.
TRACE MEMORY TEST PASSED	E	For more details refer to the Service Manual.
UNEXPECTED TEXT STRING	E	HP-IB. Received text in quotes with no prior command (such as enter annotation).
UNMATCHED "(" AND ")"	E	The user defined math equation is in error. There must be as many opening as closing parenthesis.
UP/DOWN OR KNOB ONLY	W	Only the arrow keys in the data entry section or the KNOB may be used to move the marker.
WAITING FOR "#"	W	HP-IB. Data load in the binary format is waiting for the starting sequence "#!".
WAITING FOR DATA TRANSFER	W	HP-IB. Waiting for a data-receiving device to handshake.
WAITING FOR INPUT DATA	W	HP-IB. Load ready and waiting for input data.
WARNING: TRACE IS OFF	W	This message appears when an operation is performed with the active trace OFF

HP 3577A Programming Codes

DISPLAY FORMAT

Function	HP-IB	Function	HP-IB
TRACE 1	TR1	Input = S22	I22
TRACE 2	TR2	Copy Input	CPI
DISPLAY FUNCTION	DSF *	Test Set Forward	TSF
Log Magnitude	DF7	Test Set Reverse	TSR
Linear Magnitude	DF6	SCALE	SCL *
Phase	DF5	Autoscale	ASL
Polar	DF4	Reference Level (entry)	REF
Real	DF3	Scale/DIV (entry)	DIV
Imaginary	DF2	Reference Position (entry)	RPS
Delay	DF1	Reference Line Off	RL0
Trace Off	DF0	Reference Line On	RL1
Delay Aperture menu	DAP *	Copy Scale	CPS
Aperture .5% of span	AP1	Phase Slope (entry)	PSL
Aperture 1% of span	AP2	Phase Slope Off	PS0
Aperture 2% of span	AP3	Phase Slope On	PS1
Aperture 4% of span	AP4	Polar Full Scale (entry)	PFS
Aperture 8% of span	AP5	Polar Phase Ref (entry)	PPR
Aperture 16% of span	AP6	Smith Chart Off	GT0
Return	RET *	Smith Chart On	GT1
INPUT	INP *	MARKER	MKR *
Input = R	INR	Marker Position (entry)	MKP
Input = A	INA	Marker Off	MRO
Input = B	INB	Marker On	MR1
Input = A/R	IAR	Zero Marker	ZMK
Input = B/R	IBR	Marker Offset Off	MO0
Input = D1	ID1	Marker Offset On	MO1
Input = D2	ID2	Marker Offset (entry)	MKO
Input = D3	ID3	Marker Offset Freq (entry)	MOF
Input = D4	ID4	Marker Offset Amp (entry)	MOA
Return	RET *	Marker Coupling Off	CO0
User Defined Input	UDI	Marker Coupling On	CO1
Input = S11	I11	Polar Mag Offset (entry)	PMO
Input = S21	I21	Polar Phase Offset (entry)	PPO
Input = S12	I12	Polar Real Offset (entry)	PRO

* Use not required. The only function of this code is to display a menu (if bus diagnostics are on).

Function	HP-IB
Polar Imag Offset (entry)	PIO
Polar Marker Units (Re/Im)	MRI
Polar Marker Units (Mg/Ph)	MMP
MARKER →	MKG *
MKR→ Reference Level	MTR
MKR→ Start Frequency	MTA
MKR→ Stop Frequency	MTB
MKR→ Center Frequency	MTC
MKR Offset→ Span	MOS
MKR→ Max	MTX
MKR→ Min	MTN
MARKER SEARCH menu	MSM *
MKR Target Value (entry)	MTV
MKR → Right for Target	MRT
MKR → Left for Target	MLT
Return	RET *
MKR → Full Scale	MTP
MKR → Polar Phase Ref	MPF
STORE DATA	STO*
Store in register D1	SD1
Store in register D2	SD2
Store in register D3	SD3
Store in register D4	SD4
Store and Display	STD
User defined store	UDS
Store to D1	TD1
Store to D2	TD2
Store to D3	TD3
Store to D4	TD4
MEASUREMENT CALIBRATION	CAL *
Normalize	NRM
Normalize (Short)	NRS
Calibrate, Partial	CPR
Calibrate, Full	CFL
Continue Calibration	CGO
DEFINE MATH	DFN *
Constant K1, Real (entry)	KR1
Constant K1, Imaginary (entry)	KI1
Constant K2, Real (entry)	KR2
Constant K2, Imaginary (entry)	KI2
Constant K3, Real (entry)	KR3
Constant K3, Imaginary (entry)	KI3
Constant K4, Real (entry)	KR4

Function	HP-IB
Define Function	DFC *
Function F1	UF1
Function F2	UF2
Function F3	UF3
Function F4	UF4
Function F5	UF5
Math term for input R	R
Math term for input A	A
Math term for input B	B
Math term for storage reg	D
Math term for constant	K
Math term for function	F
Math bracket	(
Math function plus	+
Math function minus	--
Math function multiply	*
Math function divide	/
Math bracket)
Return	RET*
DATA ENTRY SECTION COMMANDS	
Increment (up arrow)	IUP
Decrement (down arrow)	IDN
Continuous Entry (knob) Off	CEO
Continuous Entry (knob) On	CE1
Entry Off	HLD
DISPLAY FORMAT SUFFIX UNITS	
dBm	DBM
dBV (rms)	DBV
dB relative	DBR
Volt (rms)	V
milli-Volt (rms)	MV
micro-Volt (rms)	UV
nano-Volt (rms)	NV
degrees	DEG
degrees/span	DSP
radians	RAD
radians/span	RSP
seconds	SEC
milliseconds	MSC
microseconds	USC
nanoseconds	NSC
percent	%
degrees/span	DSP

* Use not required. The only function of this code is to display a menu (if bus diagnostics are on).

Function	HP-IB
radians/span	RAP
MHz	MHZ
kHz	KHZ
Hz	HZ
exponent	E

SOURCE

Function	HB-IB
SWEEP TYPE	STY *
Linear Sweep	ST1
Alternate Sweep	ST2
Log Sweep	ST3
Amplitude Sweep	ST4
CW	ST5
Sweep Direction Up	SUP
Sweep Direction Down	SDN
SWEEP MODE	SMD*
Continuous	SM1
Single Sweep	SM2
Manual Sweep	SM3
Manual Frequency (entry)	MFR
Manual Amplitude (entry)	MAM
Marker → Manual	MTM
SWEEP TIME	STM*
Sweep Time (entry)	SWT
Step Time (entry)	SMT
Sample Time (entry)	MSR
FREQUENCY	FRQ*
Source Frequency (entry)	SFR
Start Frequency (entry)	FRA
Stop Frequency (entry)	FRB
Center Frequency (entry)	FRC
Frequency Span (entry)	FRS
FRC Step size (entry)	CFS
Sweep Resolution menu	SRL *
Freq Swp Res 51 pts/span	RS1
Freq Swp Res 101 pts/span	RS2
Freq Swp Res 201 pts/span	RS3
Freq Swp Res 401 pts/span	RS4
Return	RET*
Full Sweep	FSW
Freq Step Size (entry)	FST
AMPLITUDE	AMP *
Source Amplitude (entry)	SAM
Amp Step Size (entry)	AST
Clear Trip, Source	CTS
Start Amplitude (entry)	AMA
Stop Amplitude (entry)	AMB
Steps/Sweep menu	NST *
Number of steps = 6	NS1

Function	HB-IB
Number of steps = 11	NS2
Number of steps = 21	NS3
Number of steps = 51	NS4
Number of steps = 101	NS5
Number of steps = 201	NS6
Number of steps = 401	NS7
Return	RET *
Full Sweep	FSW
TRIGGER MODE	TRM *
Free Run	TG1
Line Trigger	TG2
External Trigger	TG3
Immediate	TG4
SWEEP TRIGGER	TRG
SWEEP RESET	RST
SOURCE SUFFIX UNITS	
dBm	DBM
dBV (rms)	DBV
Volt (rms)	V
milli-Volt (rms)	MV
micro-Volt (rms)	UV
nano-Volt (rms)	NV
seconds	SEC
milliseconds	MSC
MHz	MHZ
kHz	KHZ
Hz	HZ
exponent	E

* Use not required. The only function of this code is to display a menu (if bus diagnostics are on).

RECEIVER

Function	HP-IB
RESOLUTION BW	RBW *
Resolution BW 1 Hz	RW1
Resolution BW 10 Hz	RW2
Resolution BW 100 Hz	RW3
Resolution BW 1 kHz	BW4
Auto Bandwidth Off	AU0
Auto Bandwidth On	AU1
AVERAGE	AVE *
Averaging Off	AV0
N = 4	AV1
N = 8	AV2
N = 16	AV3
N = 32	AV4
N = 54	AV5
N = 128	AV6
N = 256	AV7
ATTENUATION	ATT *
Attenuation R = 0 dB	AR1
Attenuation R = 20 dB	AR2
Attenuation A = 0 dB	AA1
Attenuation A = 20 dB	AA2
Attenuation B = 0 dB	AB1
Attenuation B = 20 dB	AB2
Impedance R = 50	IR1
Impedance R = 1 M	IR2
Impedance A = 50 Ω	IA1
Impedance A = 1 M Ω	IA2
Impedance B = 50 Ω	IB1
Impedance B = 1 M Ω	IB2
Clear Trip, Receiver	CTR
LENGTH	LEN *
Length R (entry)	LNR
Length R Off	LR0
Length R On	LR1
Length A (entry)	LNA
Length A Off	LA0
Length A On	LA1
Length B (entry)	LNB
Length B Off	LBO
Length B On	LB1
Length Step Size (entry)	LNS

Function	HP-IB
RECEIVER SUFFIX UNITS	
meters	MET
centimeters	CM
seconds	SEC
milliseconds	MSC
microseconds	USC
nanoseconds	NSC
exponent	E

* Use not required. The only function of this code is to display a menu (if bus diagnostics are on).

Appendix D
Programming Codes

INSTRUMENT STATE

Function	HP-IB
SPECIAL FUNCTIONS	SPC *
Confid. (self) test menu	SLF *
Self test channel R	STR
Self test channel A	STA
Self test channel B	STB
Return	RET*
Beeper off	BP0
Beeper on	BP1
Service Diagnostics menu	SDG *
Source Leveling off	SLO
Source Leveling on	SL1
Settling Time off	SE0
Settling time on	SE1
Synthesizer Diag off	SY0
Synthesizer Diag on	SY1
Display Test Pattern	DTP
Trace Memory Test	TMT
Fast Processor Test	FPT
I/O Port Test	PRT
More Serv Diag menu	MOR *
Display Memory Test	DST
Software Revision message	SRV
Return	RET *
S-Parameters Off	SPO
S-Parameters On	SP1
SAVE INSTRUMENT STATE	SAV *
Save state in register 1	SV1
Save state in register 2	SV2
Save state in register 3	SV3
Save state in register 4	SV4
Save state in register 5	SV5
RECALL INSTRUMENT STATE	RCL *
Recall old (last) state	RLS
Recall register 1	RC1
Recall register 2	RC2
Recall register 3	RC3
Recall register 4	RC4
Recall register 5	RC5
INSTRUMENT PRESET	IPR
PLOT MENU	PLM*
Plot all	PLA
Plot trace 1	PL1

Function	HP-IB
Plot trace 2	PL2
Plot graticule	PLG
Plot characters	PLC
Plot trace 1 marker	PM1
Plot trace 2 marker	PM2
Configure Plot menu	CPT *
Trace 1 linetype (entry)	T1L
Trace 2 linetype (entry)	T2L
Trace 1 pen number (entry)	T1P
Trace 2 pen number (entry)	T2P
Graticule pen no. (entry)	PGP
Pen speed fast (max)	PNM
Pen speed slow	PNS
Set plot config to default	PLD
Return	RET*

* Use not required. The only function of this code is to display a menu (if bus diagnostics are on).

Bibliography

Fitzpatrick, J., "Error Models for Systems Measurements," Microwave Journal, May 1978.

The following are Hewlett-Packard publications:

- HP Publication #5952-9270, "Vector Measurements of High Frequency Networks."
- HP Application Note 95-1, "S-Parameter Techniques for Faster, More Accurate Network Design."
- HP Application Note 154, "S-Parameter Design."
- HP Product Note 3577A-1, "Users Guide to the HP 3577A Network Analyzer."